

# Rosemount™ 702 Wireless Discrete Transmitter



WirelessHART





# Contents

## Section 1: Introduction

1.1 Using this manual .....	1
1.2 Models covered .....	2
1.2.1 Rosemount 702DX22 Wireless Discrete Transmitter .....	2
1.2.2 Rosemount 702DX61 Wireless Discrete Transmitter for liquid hydrocarbon leak detection .....	2
1.2.3 Rosemount 702DX32 Wireless Discrete Transmitter .....	2
1.2.4 Rosemount 702DX42 Wireless Discrete Transmitter .....	2
1.3 Transmitter overview .....	3
1.3.1 Functions of the transmitter.....	3
1.3.2 Wireless considerations.....	3
1.3.3 Choosing an installation location and position.....	4
1.3.4 Electrical.....	5
1.3.5 Verifying operating atmosphere.....	5
1.4 Product recycling/disposal.....	6

## Section 2: Configuration: Models 702DX22 and 702DX61

2.1 Safety messages.....	7
2.1.1 Connecting the switches.....	7
2.2 Configuring the Device Sensor .....	8
2.3 Configuring on the bench .....	8
2.4 Configuring the device network .....	9
2.4.1 Configuring transmitter with dry contact inputs, measurement option code 22 (702DX22).....	9
2.4.2 Configuring transmitter with liquid hydrocarbon detection, measurement option code 61(702DX61).....	10
2.5 HART menu tree.....	11
2.5.1 Dry contact inputs, measurement option code 22 (702DX22).....	11
2.5.2 Liquid hydrocarbon detection, measurement option code 61(702DX61) .....	12
2.5.3 Fast Key sequence .....	13
2.6 Remove power module .....	13

## Section 3: Mounting, Wiring Switches, and Sensors: Models 702DX22 and 702DX61

3.1	Safety messages	15
3.2	Installing the transmitter	16
3.2.1	Direct mount configuration	16
3.2.2	Remote mount configuration	18
3.3	Wiring switches and sensors	19
3.3.1	Dry contact inputs, measurement option code 22 (702DX22)	19
3.3.2	Wireless output specifications	19
3.3.3	Liquid hydrocarbon detection, measurement option code 61(702DX61)	21
3.4	LCD display	23
3.5	Grounding the transmitter	24

## Section 4: Commissioning: Models 702DX22 and 702DX61

4.1	Safety messages	27
4.2	Configuring the transmitter to communicate with the wireless network	28
4.3	AMS Wireless Configurator	28
4.4	Field Communicator	28
4.5	Verifying operation	29
4.5.1	AMS Wireless Configurator	31

## Section 5: Operation and Maintenance: Models 702DX22 and 702DX61

5.1	Safety Messages	33
5.2	Discrete input from switches and sensors	34
5.2.1	Dry contact inputs, measurement option code 22 (702DX22)	34
5.2.2	Wireless output specifications	34
5.2.3	Liquid hydrocarbon detection, measurement option code 61 (702DX61)	36
5.3	LCD display screen messages	40
5.3.1	Startup screen sequence	40
5.3.2	Diagnostic button screen sequence	42
5.3.3	Network connection status screens	43
5.3.4	Device diagnostic screens	45
5.4	Replacing the power module	48
5.5	Service support	49

## Section 6: Configuration: Models 702DX32 and 702DX42

6.1	Safety messages	51
6.1.1	Ensuring proper switch connections	52
6.2	Discrete channel configuration	52
6.3	Device network configuration	52
6.3.1	Dry contact inputs, measurement option code 32, 42 (Models 702DX32 and 702DX42)	53
6.4	HART menu tree	55
6.4.1	Fast Key sequence	58
6.5	Removing the power module	58

## Section 7: Mounting, Wiring Switches, and Output Circuits: Models 702DX32 and 702DX42

7.1	Safety messages	59
7.2	Installing the transmitter	60
7.2.1	Direct mount	60
7.2.2	Remote mount	62
7.3	Wiring switches and sensors	63
7.3.1	Dry contact inputs, measurement option code 32, 42 (702DX32, 702DX42)	63
7.3.2	Dry contact switch inputs	63
7.3.3	Output circuits, measurement option code 42 (702DX42)	65
7.3.4	Safety shower and eye wash monitoring	67
7.4	LCD display	70
7.5	Grounding the transmitter	71

## Section 8: Commissioning: Models 702DX32 and 702DX42

8.1	Safety messages	73
8.2	Configuring wireless network communication	74
8.3	Verifying operation	74
8.3.1	AMS Wireless Configurator	77

## Section 9: Operation and Maintenance: Models 702DX32 and 702DX42

9.1	Safety messages	79
9.2	Discrete input from switches	80
9.2.1	Dry contact inputs, measurement option code 32, 42 (702DX32, 702DX42)	80
9.2.2	Wireless output specifications	80
9.2.3	Momentary discrete inputs, measurement option code 32 and 42 (702DX32, 702DX42)	82
9.3	Discrete output circuits	86
9.4	Modbus and OPC mapping	90
9.5	Interpreting the LCD display screen messages	90
9.5.1	Startup screen sequence	90
9.5.2	Diagnostic button screen sequence	92
9.5.3	Network connection status screens	93
9.5.4	Device diagnostic screens	95
9.6	Replacing the power module	97
9.7	Service support	98

## Appendix A: Reference Data

A.1	Product Certifications	99
A.2	Ordering Information, Specifications, and Drawings	99

## Appendix B: High Gain Remote Antenna Option

B.1	Safety messages	101
B.2	Functional specifications	102
B.3	Installation considerations	103
B.4	Transient/lightning considerations	103
B.5	Dimensional drawings	104
B.6	Installing the high gain remote antenna	105

## Appendix C: Safety Shower Monitoring

C.1	Installation instructions	109
C.2	Installation drawings	111

# Rosemount™ 702 Wireless Discrete Transmitter

## NOTICE

Read this manual before working with the product. For personal and system safety, and for optimum product performance, make sure to thoroughly understand the contents before installing, using, or maintaining this product.

The United States has two toll-free assistance numbers and one international number.

### Customer Central

1 800 999 9307 (7:00 a.m. to 7:00 p.m. CST)

### National Response Center

1 800 654 7768 (24 hours a day)

Equipment service needs

### International

1 952 906 8888

The products described in this document are NOT designed for nuclear-qualified applications.

Using non-nuclear qualified products in applications that require nuclear-qualified hardware or products may cause inaccurate readings.

For information on Rosemount nuclear-qualified products, contact an Emerson™ Sales Representative.

## ⚠ WARNING

### Explosions could result in death or serious injury.

- Installation of this transmitter in an explosive environment must be in accordance with the appropriate local, national, and international standards, codes, and practices.
- Review the approvals section of this manual for any restrictions associated with a safe installation.
- Before connecting a Field Communicator in an explosive atmosphere, ensure the instruments are installed in accordance with intrinsically safe or non-incendive field wiring practices.

### Process leaks may cause harm or result in death.

Install and tighten process connectors before applying pressure.

### Electrical shock can result in death or serious injury.

Avoid contact with the leads and terminals. High voltage that may be present on leads can cause electrical shock.

## **⚠ CAUTION**

The Rosemount 702 Transmitter and all other wireless devices should be installed only after the Emerson Wireless Gateway has been installed and is functioning properly. Wireless devices should also be powered up in order of proximity from the Gateway, beginning with the closest. This will result in a simpler and faster network installation.

### **Shipping considerations for wireless products.**

The unit was shipped to you without the power module installed. Remove the power module prior to shipping.

Each power module contains two “C” size primary lithium batteries. Primary lithium batteries are regulated in transportation by the U. S. Department of Transportation, and are also covered by IATA (International Air Transport Association), ICAO (International Civil Aviation Organization), and ARD (European Ground Transportation of Dangerous Goods). It is the responsibility of the shipper to ensure compliance with these or any other local requirements. Consult current regulations and requirements before shipping.

The power module with the wireless unit contains two “C” size primary lithium/thionyl chloride batteries. Each battery contains approximately 2.5 grams of lithium, for a total of 5 grams in each pack. Under normal conditions, the battery materials are self-contained and are not reactive as long as the batteries and the pack integrity are maintained. Care should be taken to prevent thermal, electrical, or mechanical damage. Contacts should be protected to prevent premature discharge.

### **Battery hazards remain when cells are discharged.**

Power modules should be stored in a clean and dry area. For maximum battery life, storage temperature should not exceed 30 °C.

The power module has surface resistivity greater than one gigaohm and must be properly installed in the wireless device enclosure. Care must be taken during transportation to and from the point of installation to prevent electrostatic charge build-up.

---



# Section 1 Introduction

## 1.1 Using this manual

The sections in this manual provide information on installing, operating, and maintaining the Rosemount™ 702 Wireless Discrete Transmitter. [Section 2](#) through [Section 5](#) are for the Rosemount 702DX22 and Rosemount 702DX61 models. The Rosemount 702DX22 is the legacy 702 Transmitter that has discrete input function only. The Rosemount 702DX61 is a special version for liquid hydrocarbon leak detection with Tyco® TraceTek® Sensors. [Section 6](#) through [Section 9](#) are for the Rosemount 702DX32 and Rosemount 702DX42 models. The Rosemount 702DX32 has all of the functionality of the 702DX22, with the addition of momentary discrete input sensing and counting. The 702DX42 adds the capability of discrete output switching.

Model number	Functionality	Manual sections
702DX22	Two channel discrete input	1, 2, 3, 4, 5
702DX61	One channel for Tyco TraceTek liquid hydrocarbon leak detection	1, 2, 3, 4, 5
702DX32	Two channel discrete input with momentary input detection and counting	1, 6, 7, 8, 9
702DX42	Two channel discrete input or discrete output, with momentary input detection and counting	1, 6, 7, 8, 9

The manual sections are organized as follows:

[Section 2: Configuration: Models 702DX22 and 702DX61](#) contains information on the configuration of the Rosemount 702 Transmitter so that it can be added to the wireless network. This configuration can be done using the AMS Suite Wireless Configurator or a Field Communicator. Field Communicator menu trees are here.

[Section 3: Mounting, Wiring Switches, and Sensors: Models 702DX22 and 702DX61](#) contains information on the mounting of the Rosemount 702 Transmitter and wiring of switches and sensor to the transmitter.

[Section 4: Commissioning: Models 702DX22 and 702DX61](#) contains information for the commissioning of the Rosemount 702 Transmitter onto the wireless network, and how to verify that the transmitter has successfully joined.

[Section 5: Operation and Maintenance: Models 702DX22 and 702DX61](#) provides detailed information on operation of the Rosemount 702 Transmitter with various switch and sensor configurations. LCD display messages are shown. Power Module replacement is described.

[Section 6: Configuration: Models 702DX32 and 702DX42](#) contains information on the configuration of the Rosemount 702 Transmitter so that it can be added to the wireless network. This configuration can be done using the AMS Wireless Configurator or a Field Communicator. Field Communicator menu trees are here.

[Section 7: Mounting, Wiring Switches, and Output Circuits: Models 702DX32 and 702DX42](#) contains information on the mounting of the Rosemount 702 Transmitter and wiring of switches and sensor to the transmitter.

[Section 8: Commissioning: Models 702DX32 and 702DX42](#) contains information for the commissioning of the Rosemount 702 Transmitter onto the wireless network, and how to verify that the transmitter has successfully joined.

[Section 9: Operation and Maintenance: Models 702DX32 and 702DX42](#) provides detailed information on operation of the Rosemount 702 Transmitter with various switch and sensor configurations. Also described are: Momentary discrete input detection and counting, discrete output switch function, and variable reporting and mapping. LCD display messages are shown. Power module replacement is described.

[Appendix A: Reference Data](#) supplies procedure on how to get the specifications, ordering information, and product certification.

[Appendix B: Product Certifications](#) contains telecommunication compliance information, ordinary location certification, hazardous locations certificates and intrinsic safety installation drawings.

[Appendix C: High Gain Remote Antenna Option](#) describes the high gain remote antenna, its specifications and installation.

## 1.2 Models covered

The following Rosemount 702 Transmitters are covered by this manual:

### 1.2.1 Rosemount 702DX22 Wireless Discrete Transmitter

- Two input channels
- Discrete input only

### 1.2.2 Rosemount 702DX61 Wireless Discrete Transmitter for liquid hydrocarbon leak detection

- Detects hydrocarbon leaks using Tyco TraceTek Sensor
- Color coded terminal block for easy wiring of Tyco sensors
- Compatible with Tyco TT5000 TraceTek Fuel Sensing cable
- Compatible with Tyco TT-FSS TraceTek Fast Fuel Sensor

### 1.2.3 Rosemount 702DX32 Wireless Discrete Transmitter

- Two discrete input channels
- Momentary input detection and counting

### 1.2.4 Rosemount 702DX42 Wireless Discrete Transmitter

- Two channels
- Each channel configurable to discrete input or discrete output
- Momentary input detection and counting
- Discrete output switch function

## 1.3 Transmitter overview

Features of the Rosemount 702 Transmitter include:

- An installation-ready solution that provides a variety of mounting options, transmitter configurations, and switches
- Flexibility to meet your most demanding applications
- Wireless output with >99percent data reliability delivers rich HART® data, protected by industry leading security
- Single or dual switch input with logic for limit contact and opposing contact applications
- The integral LCD display conveniently displays the primary switch input and diagnostics of the transmitter
- Simple and easy installation practices currently being used for robust installations

### 1.3.1 Functions of the transmitter

Switches produce either an open or closed signal. By using simple HART configuration, the transmitter converts the switch signal to a wireless-enabled signal.

### 1.3.2 Wireless considerations

#### Power up sequence

The Emerson™ Wireless Gateway should be installed and functioning properly before any wireless field devices are powered. Install the Black Power Module, SmartPower™ Solutions model number 701PBKKF (part number 00753-9220-0001) into the Rosemount 702 Transmitter to power the device. Wireless devices should also be powered up in order of proximity from the Gateway, beginning with the closest. This will result in a simpler and faster network installation. Enable Active Advertising on the Gateway to ensure that new devices join the network faster. For more information see the Emerson Wireless Gateway [Reference Manual](#).

#### Antenna position

The antenna should be positioned vertically, either straight up or straight down, and it should be approximately 3 ft. (1 m) from any large structure, building, or conductive surface to allow for clear communication to other devices.

Figure 1-1. Antenna Position

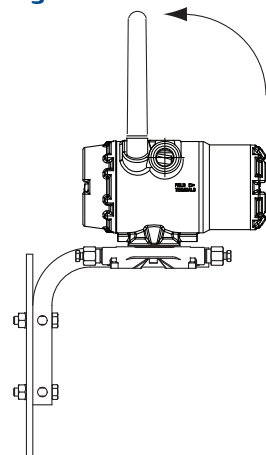

## Preparing (or sealing) the conduit entries

Upon installation, ensure that each conduit entry is either sealed with a conduit plug with appropriate thread sealant, or has an installed conduit fitting or cable gland with appropriate thread sealant.

Figure 1-2. Locating Conduit Entries

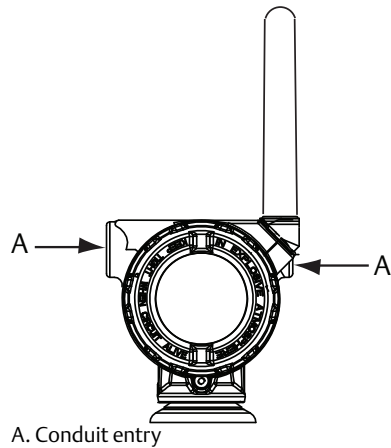

## Connecting the Field Communicator to the power module

The power module needs to be connected for the Field Communicator to interface with the transmitter.

Figure 1-3. Field Communicator Connections

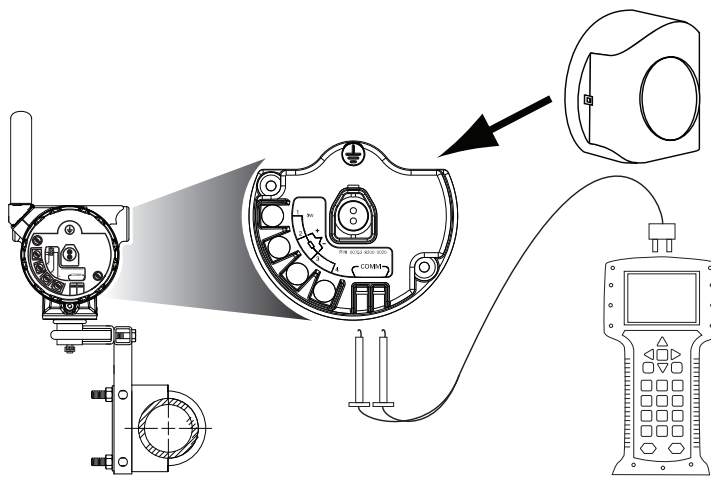

### 1.3.3 Choosing an installation location and position

When choosing an installation location and position, take into account access to the Rosemount 702 Transmitter. For best performance, the antenna should be vertical with space between objects in a parallel metal plane, such as a pipe or metal framework, as the pipes or framework may adversely affect the antenna's performance.

## 1.3.4 Electrical

### Caring for the power module

The Rosemount 702 Transmitter is self-powered. The included Black Power Module contains two “C” size primary lithium/thionyl chloride batteries. Each battery contains approximately 2.5 grams of lithium, for a total of 5 grams in each pack. Under normal conditions, the battery materials are self-contained and are not reactive as long as the batteries and the power module are maintained. Care should be taken to prevent thermal, electrical, or mechanical damage. Contacts should be protected to prevent premature discharge.

⚠ Use caution when handling the power module, it may be damaged if dropped from heights in excess of 20 ft. (6,10 m).

### Making switch connections

Make switch connections through the cable entry in the side of the connection head. Be sure to provide adequate clearance for cover removal.

## 1.3.5 Verifying operating atmosphere

Verify that the operating atmosphere of the transmitter is consistent with the appropriate hazardous locations certifications.

### Isolating the transmitter from sources of heat

The transmitter will operate within specifications for ambient temperatures between  $-40$  and  $185$  °F ( $-40$  and  $85$  °C). Heat from the process is transferred from the switch to the transmitter housing. If the expected process temperature is near or beyond specification limits, consider using an extension, or remote mount the transmitter to thermally isolate it from the process.

Figure 1-4 provides an example of the relationship between the transmitter housing temperature rise and the extension length.

**Figure 1-4. Rosemount 702 Transmitter Connection Head Temperature Rise vs. Extension Length**

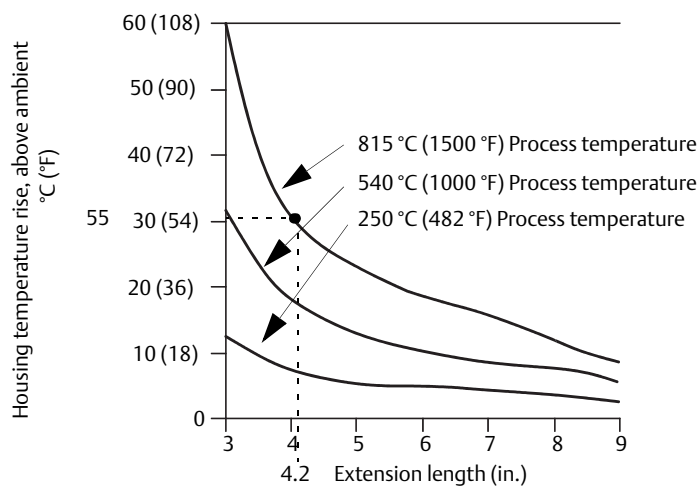

## Example

The transmitter specification limit is 185 °F (85 °C). If the ambient temperature is 131 °F (55 °C) and the maximum process temperature to be measured is 1500 °F(815 °C), the maximum permissible connection head temperature rise is the transmitter specification limit minus the ambient temperature (moves 185 °F to 131 °F [85 to 55 °C]), or 86 °F (30 °C).

In this case, an extension of 5-in. (0.13 m) meets this requirement, but 6-in. (0.15 m) provides an additional margin of protection, thereby reducing risk of ambient thermal damage.

## Temperature limits

	Operating limit	Storage limit
With LCD display	-40 to 175 °F -20 to 80 °C	-40 to 185 °F -40 to 85 °C
Without LCD display	-40 to 185 °F -40 to 85 °C	-40 to 185 °F -40 to 85 °C

## 1.4 Product recycling/disposal

Recycling of equipment and packaging should be taken into consideration. The product and packaging should be disposed of in accordance with local and national legislation.

# Section 2 Configuration: Models 702DX22 and 702DX61

---

Safety messages .....	page 7
Configuring the Device Sensor .....	page 8
Configuring the device network .....	page 9
HART menu tree .....	page 11
Remove power module .....	page 13

---

## 2.1 Safety messages

Instructions and procedures in this section may require special precautions to ensure the safety of the personnel performing the operations. Information that potentially raises safety issues is indicated by a warning symbol (⚠). Refer to the following safety messages before performing an operation preceded by this symbol.

### **⚠ WARNING**

**Failure to follow these installation guidelines could result in death or serious injury.**

Only qualified personnel should perform the installation.

**Explosions could result in death or serious injury.**

- Before connecting a Field Communicator in an explosive atmosphere, make sure that the instruments are installed in accordance with intrinsically safe or non-incendive field wiring practices.
- Verify that the operating atmosphere of the transmitter is consistent with the appropriate hazardous locations certifications.

**Process leaks could result in death or serious injury.**

- Do not remove the switch while in operation.
- Install and tighten switches before applying pressure.

**Electrical shock could cause death or serious injury.**

Use extreme caution when making contact with the leads and terminals

---

### 2.1.1 Connecting the switches

The Rosemount™ 702 Wireless Discrete Transmitter is compatible with a number of simple switches. When ordered in the optional configuration for Liquid Hydrocarbon Detection, option code 61, the transmitter is compatible with Tyco® TraceTek® Fast Fuel Sensors and TraceTek Sensing cable. [Figure 2-1 on page 9](#) shows the correct input connections to the switch terminals on the transmitter. To ensure a proper switch connection, anchor the switch lead wires into the appropriate compression terminals and tighten the screws.

## Wiring the transmitter

 If the switch is installed in a high-voltage environment and a fault condition or installation error occurs, the sensor leads and transmitter terminals could carry lethal voltage. Use extreme caution when making contact with the leads and terminals.

Use the following steps to wire the sensor and power supply to the transmitter:

1. Remove the transmitter enclosure cover (if applicable).
2. Attach the sensor leads according to the wiring diagram [Figure 2-2 on page 10](#).
3. Connect the Black Power Module.
4. Verify the connection by viewing the LCD.
5. Replace the cover and tighten (if applicable).

## 2.2 Configuring the Device Sensor

Remove the power module-side housing cover to expose the terminal block and HART® Communication terminals, then connect the power module to power the unit for configuration. The Rosemount 702 Transmitter will receive any HART Communication from a Field Communicator, or AMS Wireless Configurator.

## 2.3 Configuring on the bench

### Field Communicator

When using a Field Communicator, any configuration changes must be sent to the transmitter using the Send key (F2). AMS Wireless Configurator configuration changes are implemented when the **Apply** button is clicked.

### AMS Wireless Configurator

AMS Wireless Configurator is capable of connecting to devices directly, using a HART modem, or with the Gateway. When configuring on the bench with a HART modem, double click the device icon, then select the *Configure/Setup* tab (or right click and select **Configure/Setup**). Configure the device settings using the Direct Connection menu. When configuring with the Gateway, double click the device icon then select the *Configure/Setup* tab (or right click and select **Configure/Setup**). Configure the device settings using the Wireless Connection menu. To check or change sensor configuration using a Field Communicator, enter the following Fast Key Sequence: 2, 2, 2.



## 2.4 Configuring the device network

### Field Communicator

To communicate with the Gateway, and ultimately the information system, the transmitter must be configured to communicate with the wireless network.

Using a Field Communicator or AMS Wireless Configurator, enter the Network ID and Join Key so they match the Network ID and Join Key of the Gateway and the other devices in the network. If the Network ID and Join Key are not identical, the transmitter will not communicate with the network. The Network ID and Join Key may be obtained from the Gateway on the *Setup>Network>Settings* page on the web server. Using a Field Communicator, the Network ID can be configured by entering the Fast Key Sequence: 2, 2, 1, 1. The Join Key can also be configured using a Field Communicator with the Fast Key Sequence: 2, 2, 1, 2.

### AMS Wireless Configurator

The final device network configuration piece is the Update Rate which, by default, is 1 minute. It can be changed at commissioning, or at any time, by using AMS Wireless Configurator or the Gateway's web server. The update rate should be between 4 seconds and 60 minutes. To change the Update Rate with a Field Communicator, use the Fast Key Sequence: 2, 2, 1, 3.

If doing a bench top initial configuration, after completion remove the power module until installation. When the device is installed, insert the power module and close the housing cover securely. Always ensure a proper seal so that metal touches metal, but do not overtighten.

### 2.4.1 Configuring transmitter with dry contact inputs, measurement option code 22 (702DX22)

Figure 2-1. Terminal Block

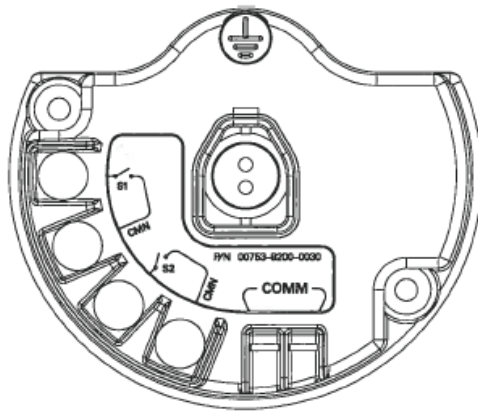

Connect the HART Communication leads to the COMM terminals on the terminal block.

## 2.4.2 Configuring transmitter with liquid hydrocarbon detection, measurement option code 61 (702DX61)

### Making terminal block connections

Figure 2-2. Fuel Sensor Terminal Diagram

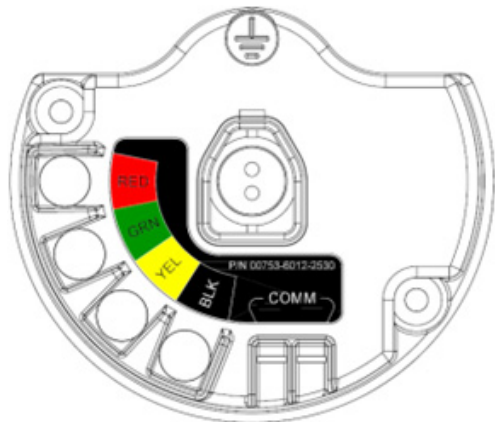

Connect Tyco TraceTek and Fast Fuel sensor lead wires by matching the colors of wires to colors on terminal block.

Figure 2-3. Field Communicator Connections

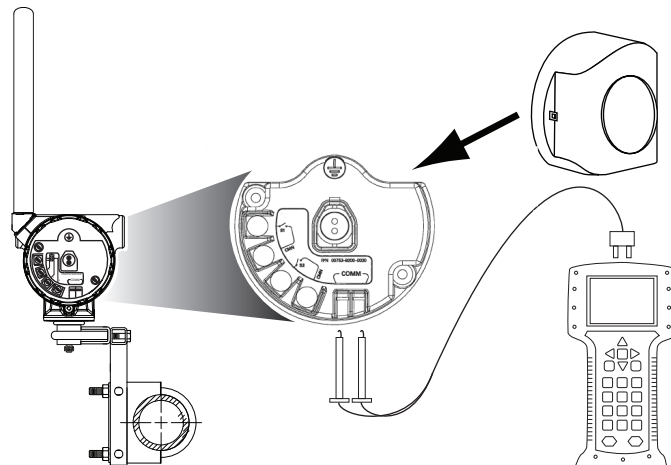

For HART Communication, a Rosemount 702 DD is required.

## 2.5 HART menu tree

For ease of operation, changing setup, such as switch type, can be completed in several locations.

### 2.5.1 Dry contact inputs, measurement option code 22 (702DX22)

Figure 2-4. Field Communicator Menu Tree, DD Revision 2

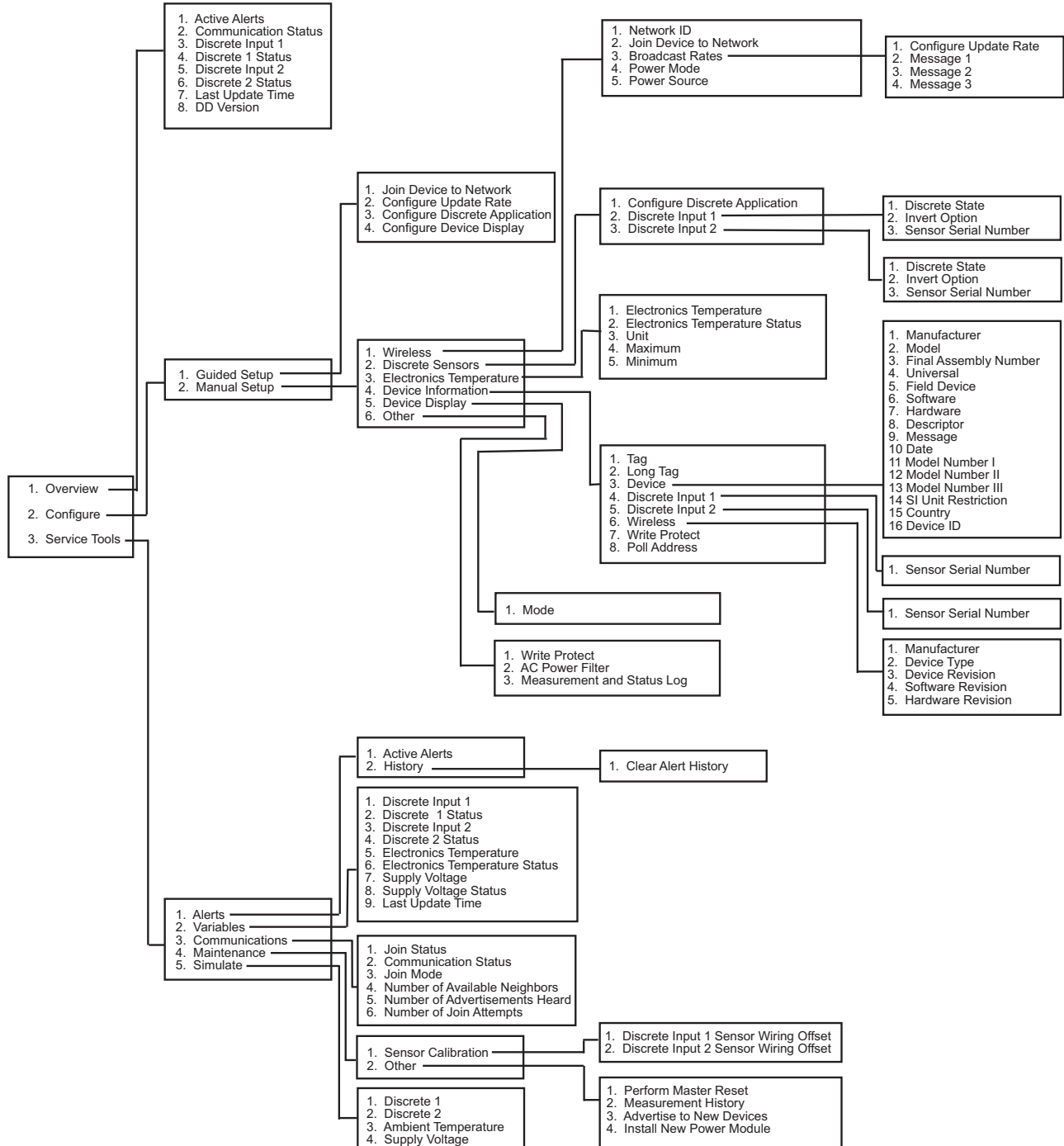

## 2.5.2 Liquid hydrocarbon detection, measurement option code 61(702DX61)

Figure 2-5. Field Communicator Menu Tree, DD Revision 1, for Leak Detection

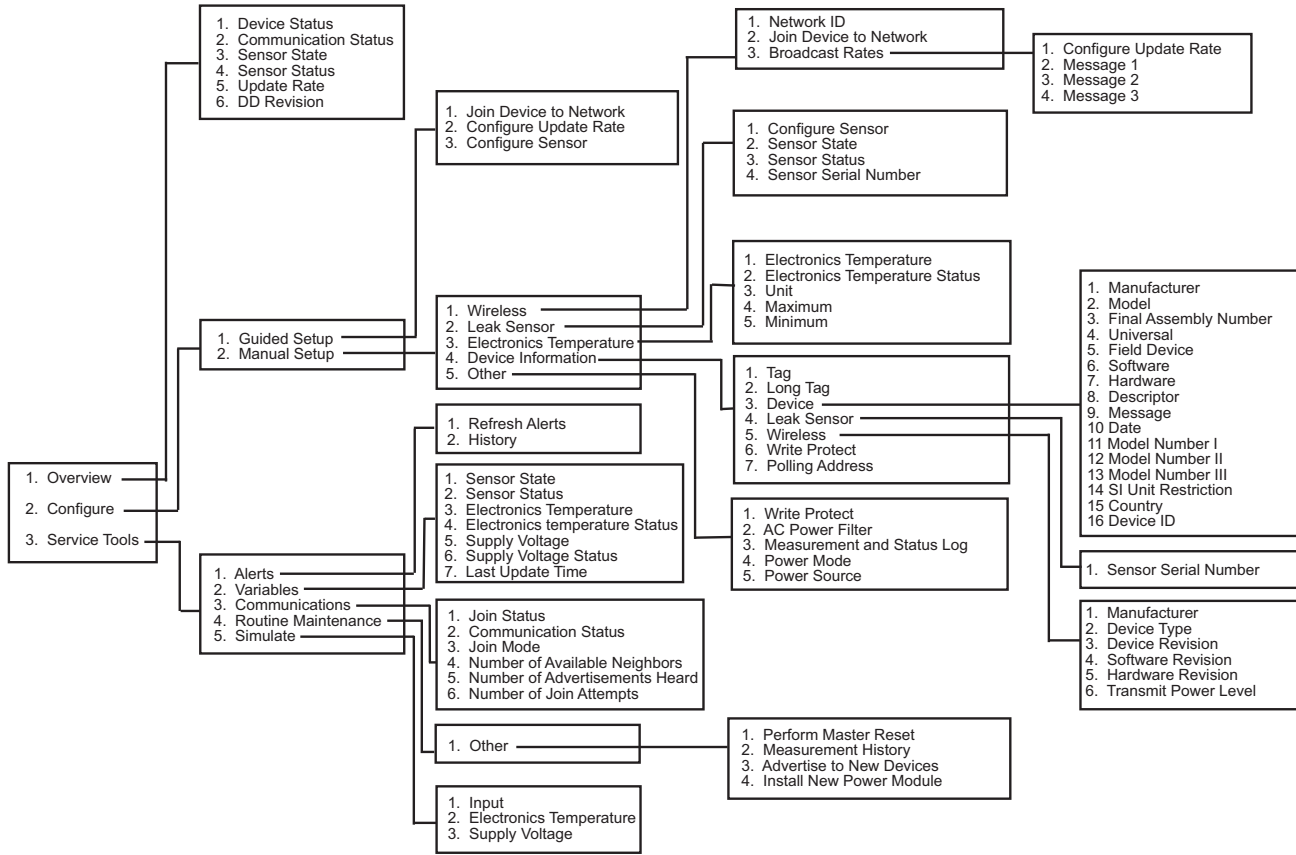

## 2.5.3 Fast Key sequence

Table lists the Fast Key sequence for common transmitter functions.

### Note

The Fast Key sequences assume that a current DD is being used: DD Rev 2 for dry contact inputs, and DD Rev 1 for leak detection.

**Table 2-1. Rosemount 702 Fast Key sequence**

Function	Key sequence	Menu items
Device Information	2, 2, 4	Manufacturer, Model, Final Assembly Number, Universal, Field Device, Software, Hardware Descriptor, Message, Date, Model Number, I, II, III, SI Unit Restriction, Country
Guided Setup	2, 1	Join Device to Network, Configure Update Rate, Configure Sensor, Calibrate Sensor, Configure Display, Configure Process Alarms
Manual Setup	2, 2	Wireless, Process Sensor, Percent of Range, Device Temperature, Device Information, Device Configure, Other
Wireless	2, 2, 1	Network ID, Join Device to Network, Configure Update Rate, Configure Broadcast Power Level, Power Mode, Power Source
Discrete Input Configuration	2, 2, 2	Discrete Input Configuration

## 2.6 Remove power module

After the sensor and network have been configured, remove the power module and replace the transmitter cover. The power module should be inserted only when the device is ready for commissioning.



# Section 3 Mounting, Wiring Switches, and Sensors: Models 702DX22 and 702DX61

---

Safety messages .....	page 15
Installing the transmitter .....	page 16
Wiring switches and sensors .....	page 19
LCD display .....	page 23
Grounding the transmitter .....	page 24

---

## 3.1 Safety messages

Instructions and procedures in this section may require special precautions to ensure the safety of the personnel performing the operations. Information that potentially raises safety issues is indicated by a warning symbol (⚠). Refer to the following safety messages before performing an operation preceded by this symbol.

### **⚠ WARNING**

#### **Failure to follow these installation guidelines could result in death or serious injury.**

Only qualified personnel should perform the installation.

#### **Explosions could result in death or serious injury.**

- Before connecting a Field Communicator in an explosive atmosphere, make sure that the instruments are installed in accordance with intrinsically safe or non-incendive field wiring practices.
- Verify that the operating atmosphere of the transmitter is consistent with the appropriate hazardous locations certifications.

#### **Process leaks could result in death or serious injury.**

- Do not remove the switch while in operation.
- Install and tighten switches before applying pressure.

#### **Electrical shock could cause death or serious injury.**

- Use extreme caution when making contact with the leads and terminals.
  - This device complies with Part 15 of the FCC Rules. Operation is subject to the following conditions: This device may not cause harmful interference. This device must accept any interference received, including interference that may cause undesired operation.
  - This device must be installed to ensure a minimum antenna separation distance of 20 cm from all persons.
-

## 3.2 Installing the transmitter

The Rosemount™ 702 Wireless Discrete Transmitter can be installed in one of two configurations:

**Direct mount:** The switch is connected directly to the transmitter housing's conduit entry. For installation instructions see “[Direct mount configuration](#)” on page 16.

**Remote mount:** The switch is mounted separate from the transmitter housing, then connected to the transmitter via conduit. For installation instructions see “[Remote mount configuration](#)” on page 18. Use Remote mount instructions for the installation of liquid hydrocarbon sensors.

### 3.2.1 Direct mount configuration

1. Install the switch according to standard installation practices making sure to use thread sealant on all of the connections.
2. Attach the Rosemount 702 Transmitter housing to the switch by using the pipe fittings threaded into the conduit entries.

---

#### Note

Direct mount installation should not be employed when using tubing and connectors such as Swagelok® fittings.

---

3. Attach the switch wiring to the terminals as shown in the wiring diagrams beginning on [page 19](#).
  4. If commissioning the device, install the Black Power Module.
- 

**Figure 3-1. Direct Mount**

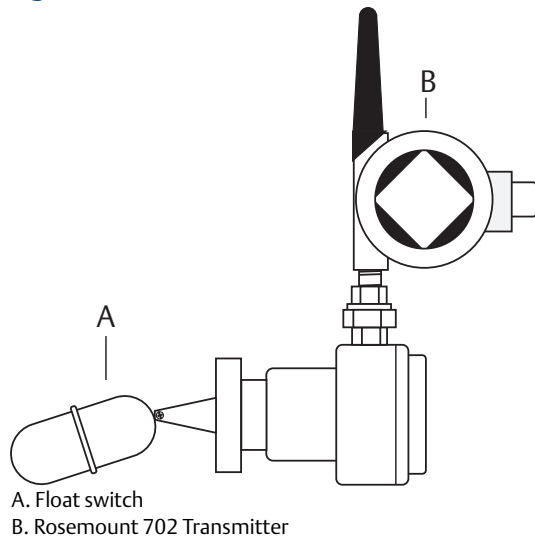

A. Float switch  
B. Rosemount 702 Transmitter

---

#### Note

Use caution when handling the power module, it may be damaged if dropped from heights in excess of 20 ft.

---



---

**Note**

Wireless devices should only be powered up after the Emerson™ Wireless Gateway, in order of proximity from the Gateway beginning with the closest device. This results in a simpler and faster network installation.

---

**Figure 3-2. Power Module Installation**

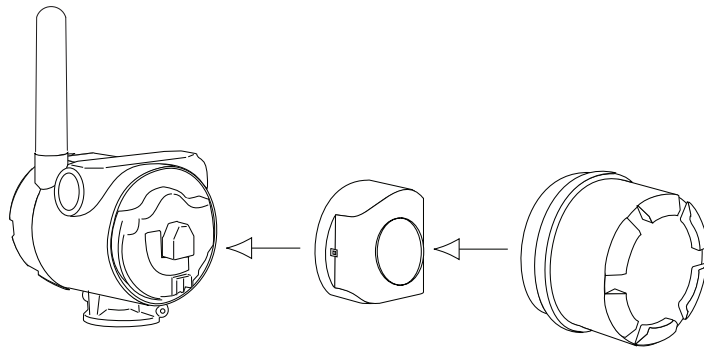

5. Close the housing cover and tighten to safety specifications. Always ensure a proper seal by installing the electronic housing covers so that metal touches metal, but do not overtighten.
  6. Position the antenna such that it is vertical, either straight up or straight down, as shown in [Figure 3-3](#). The antenna should be approximately 3 ft. (1 m) from any large structures or buildings, to allow clear communication to other devices.
- 

**Figure 3-3. Antenna Positioning**

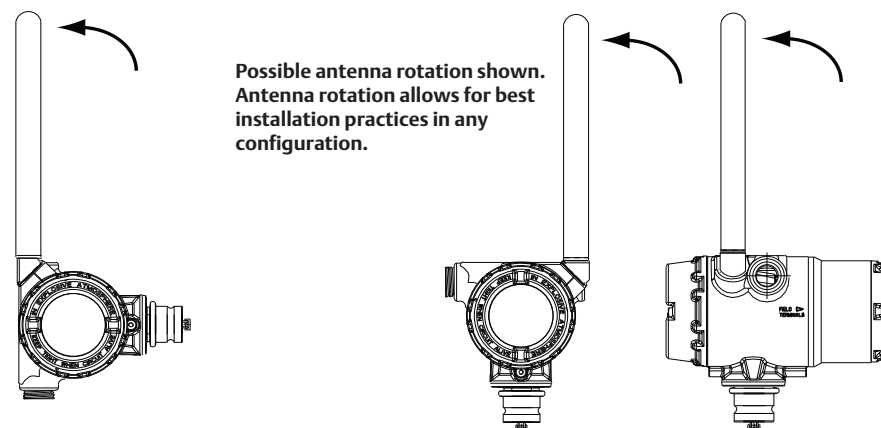

### 3.2.2 Remote mount configuration

1. Install the switch according to standard installation practices being sure to use thread sealant on all of the connections.
2. Run wiring (and conduit, if necessary) from the switch to the Rosemount 702 Transmitter.
3. Pull the wiring through the threaded conduit entry.
4. Attach the switch wiring to the terminals as shown in the wiring diagrams beginning on [page 19](#).
5. If commissioning the Transmitter, connect the Power Module as shown in [Figure 3-2 on page 17](#).

**Figure 3-4. Remote Mount**

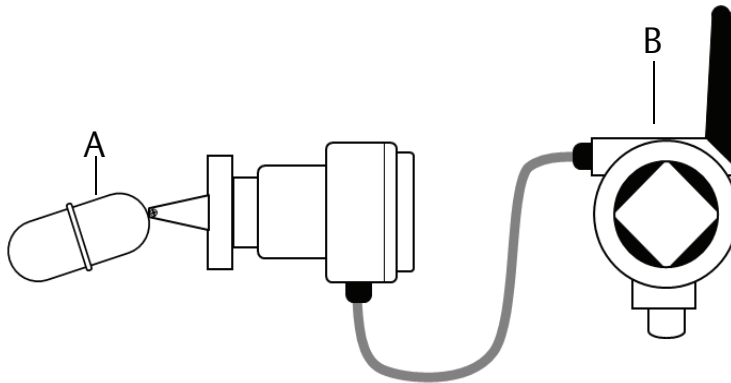

- A. Float switch
- B. Rosemount 702 Transmitter

**Note**

Use caution when handling the power module, it may be damaged if dropped from heights in excess of 20 ft.

**Note**

Wireless devices should only be powered up after the Emerson Wireless Gateway, in order of proximity from the Gateway beginning with the closest device. This results in a simpler and faster network installation.

6. Close the housing cover and tighten to safety specifications. Always ensure a proper seal by installing the electronic housing covers so that metal touches metal, but do not overtighten.
7. Position the antenna such that it is vertical, either straight up or straight down, as shown in [Figure 3-3 on page 17](#). The antenna should be approximately 3 ft. (1 m) from any large structures or buildings, to allow clear communication to other devices.

## 3.3 Wiring switches and sensors

### 3.3.1 Dry contact inputs, measurement option code 22 (702DX22)

Figure 3-5. Terminal Diagram

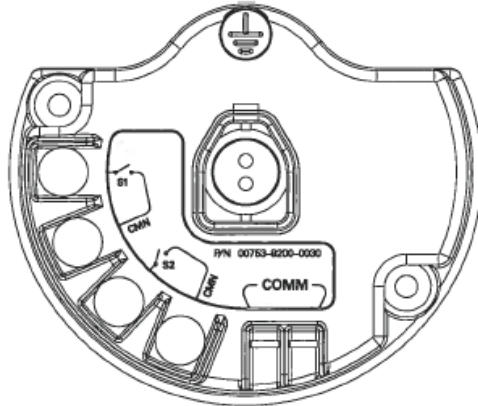

### 3.3.2 Wireless output specifications

#### Dual input

The Rosemount 702 Transmitter will accept the input from one or two single pole single throw switches on inputs S1 and S2. The wireless output of the transmitter will be both a primary variable (PV) and a secondary variable (SV). The PV is determined by the S1 input. The SV is determined by the S2 input. A closed switch drives a TRUE output. An open switch drives a FALSE output.

Figure 3-6. Single and Dual Input

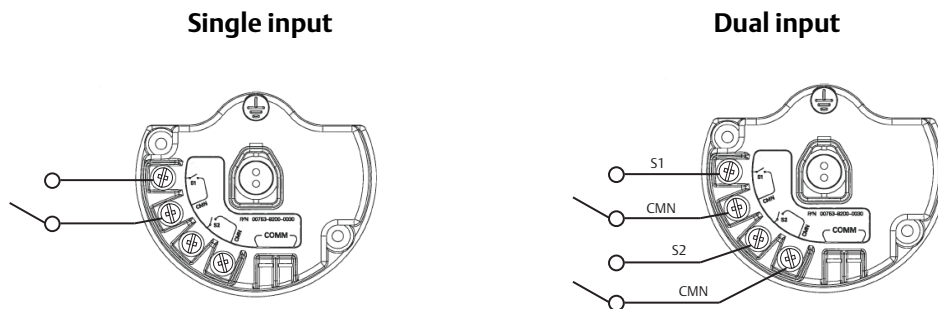

## Dual input, limit contact logic

When configured for Limit contact logic, the Rosemount 702 Transmitter will accept the input from two single pole single throw switches on inputs S1 and S2, and will use limit contact logic for the determination of the wireless outputs. Reference [Figure 3-7](#) for details on the wireless outputs available when using limit contact logic.

**Figure 3-7. Dual Input, Limit Contacts**

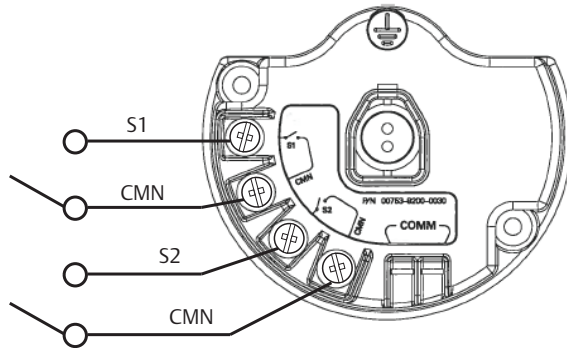

## Dual input, opposing contact logic

When configured for opposing contact logic, the Rosemount 702 Transmitter will accept the input from a single pole double throw switch on inputs S1 and S2, and will use opposing contact logic for the determination of the wireless outputs. Reference [Figure 3-8](#) for details on the wireless outputs available when using opposing contact logic.

**Figure 3-8. Dual Input, Opposing Contact**

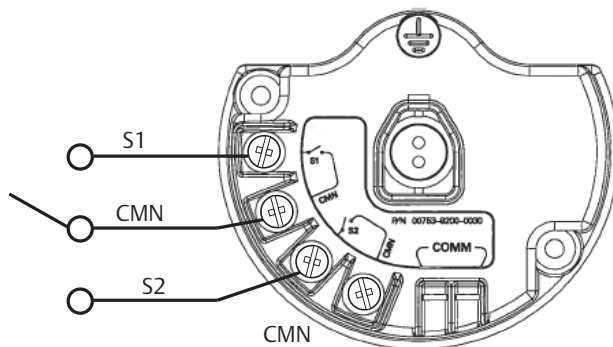

### 3.3.3 Liquid hydrocarbon detection, measurement option code 61(702DX61)

Figure 3-9. Fuel Sensor Terminal

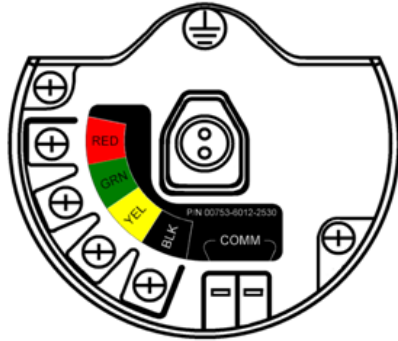

The liquid hydrocarbon detection configuration is intended for use with the Tyco® TraceTek® Fast Fuel Sensor, or TraceTek Sensing cable.

Figure 3-10. Fuel Sensor Connection

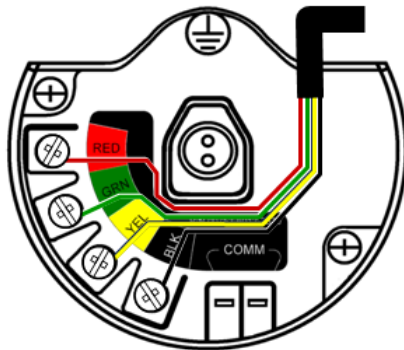

#### Connecting to the fast fuel sensor and TraceTek sensing cable

The connections to the Fast Fuel Sensor TraceTek Sensing cable are made by matching the appropriately colored wires to the matching colored termination lugs.

- The Rosemount 702 Transmitter can support up to three Tyco Fast Fuel Sensors. These sensors are connected using TraceTek Modular Leader Cable (TT-MLC-MC-BLK), optional modular jumper cables (TT-MJC-xx-MC-BLK) and branching connectors (TT-ZBC-MC-BLK) as suggested in [Figure 3-11](#).
- If more than one sensor is attached to a transmitter, the detection of liquid hydrocarbon by one sensor is sufficient to cause the transmitter to send a “Leak” message. However, it is not possible for the transmitter to discern which individual sensor has detected liquid hydrocarbon.

Figure 3-11. Fuel Sensor Wiring

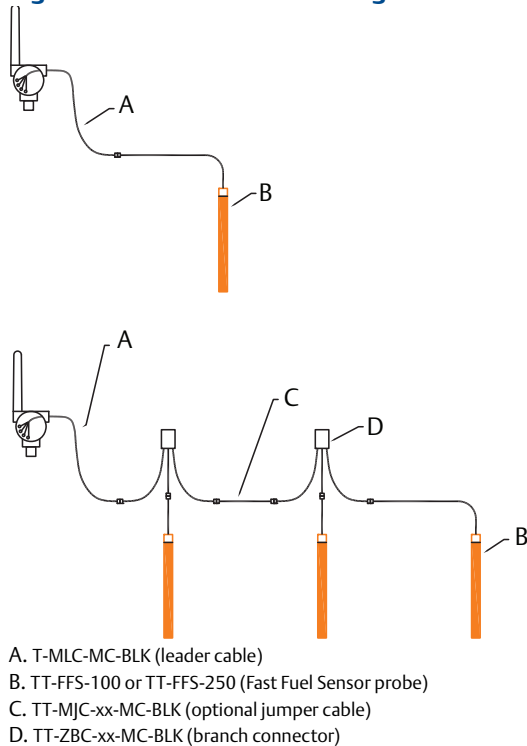

**Note**

All part numbers on this page refer to products sold by Tyco Thermo Controls, LLC.

- The Rosemount 702 Transmitter can support up to 500 ft. (150 m) of TraceTek hydrocarbon or solvent sensor cable (TT5000 or TT5001 series). The total amount of sensor cable connected to a single transmitter is not to exceed 500 ft. However leader cable, jumper cables (if used) and branch connectors are not included in the 500 ft. limit. See [Figure 3-12](#) for typical configurations.

Figure 3-12. Fuel Sensor Cable Wiring

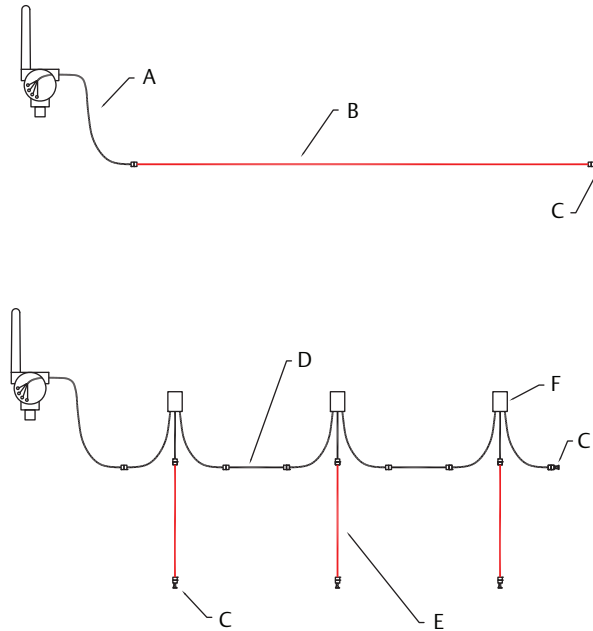

- A. TT-MLC-MC-BLK (leader cable)
- B. TT5000/TT5001 Sensor cable (up to 500 ft.)
- C. TT-MET-MC (end termination)
- D. TT-MJC-xx-MC-BLK (optional jumper cable)
- E. Up to 500 ft. TT5000 or TT5001 sensor cable (total per transmitter)
- F. TT-ZBC-xx-MC-BLK (branch connector)

## 3.4 LCD display

If an LCD display is ordered, it will be shipped attached to the transmitter.

### Note

An LCD display is not available with measurement option code 61, for liquid hydrocarbon detection.

The optional LCD display can be rotated in 90-degree increments by squeezing the two tabs, pulling out, rotating and snapping back into place.

If the LCD pins are inadvertently removed from the interface board, carefully re-insert the pins before snapping the LCD display back into place.

## Installing the LCD display

To install the LCD display, use [Figure 3-13 on page 24](#) and the following instructions:

1. Remove the LCD cover. Do not remove the instrument cover in explosive environments when the circuit is live.
2. Put the four-pin connector into the LCD display, rotate to the desired position and snap into place.

Note the following LCD temperature limits:

Operating: -4 to 175 °F (-20 to 80 °C)

Storage: -40 to 185 °F (-40 to 85 °C)

3. Replace the transmitter cover.

---

### Note

Only use Rosemount Wireless LCD part number: 00753-9004-0002.

---

**Figure 3-13. Optional LCD Display**

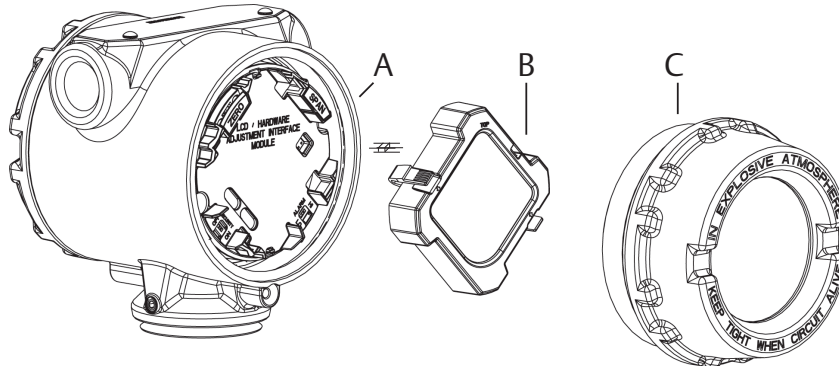

- A. LCD pins
  - B. LCD display
  - C. LCD cover
- 

## 3.5 Grounding the transmitter

The Rosemount 702 Transmitter operates with the housing grounded or floating. Floating systems, however, can cause extra noise that may affect many types of readout devices. If the signal appears noisy or erratic, grounding at a single point may solve the problem. Grounding of the electronics enclosure should be done in accordance with local and national installation codes. Grounding is accomplished through the process connection using the internal or external case grounding terminal.

### Determining grounding requirements

Each process installation has different grounding requirements. Use the options recommended by the facility for the specific switch type, or begin with Option 1, which is the most common.



Option 1:

1. Connect switch wiring shield to the grounded transmitter housing.
2. Ensure that the transmitter housing is electrically isolated from the switch wiring.

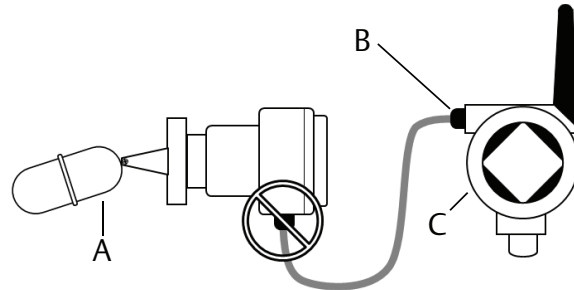

- A. Float switch
- B. Shield ground point
- C. Rosemount 702 Transmitter

Option 2:

1. Ground switch wiring shield at the switch.
2. Ensure that the switch wiring and shield are electronically isolated from the transmitter housing.

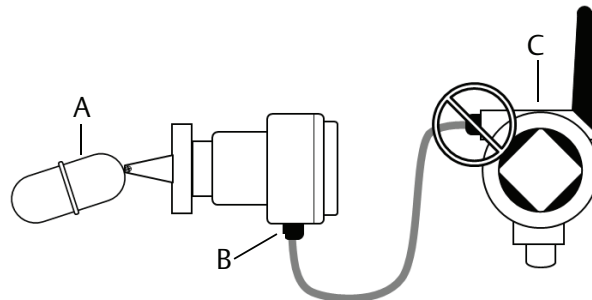

- A. Float switch
- B. Shield ground point
- C. Rosemount 702 Transmitter

**Note**

Always use facility recommended wiring practices.



---

# Section 4 Commissioning: Models 702DX22 and 702DX61

---

---

Safety messages .....	page 27
Configuring the transmitter to communicate with the wireless network .....	page 28
AMS Wireless Configurator .....	page 28
Field Communicator .....	page 28
Verifying operation .....	page 29

---

## 4.1 Safety messages

Instructions and procedures in this section may require special precautions to ensure the safety of the personnel performing the operations. Information that potentially raises safety issues is indicated by a warning symbol (⚠). Refer to the following safety messages before performing an operation preceded by this symbol.

### **⚠ WARNING**

**Failure to follow these installation guidelines could result in death or serious injury.**

Make sure only qualified personnel perform the installation.

**Explosions could result in death or serious injury.**

- Before connecting a Field Communicator in an explosive atmosphere, make sure the instruments are installed in accordance with intrinsically safe or non-incendive field wiring practices.
- Verify that the operating atmosphere of the transmitter is consistent with the appropriate hazardous locations certifications.

**Process leaks could result in death or serious injury.**

- Do not remove the switch while in operation.
- Install and tighten sensors before applying pressure.

**Electrical shock could cause death or serious injury.**

Use extreme caution when making contact with the leads and terminals.

---

### **Note**

The Rosemount™702 Wireless Discrete Transmitter and all other wireless devices should be installed only after the Gateway has been installed and is functioning properly.

Wireless devices should be powered up in order of proximity from the gateway, beginning with the device closest to the Emerson™ Wireless Gateway. This will result in a simpler and faster network installation.

---

## 4.2 Configuring the transmitter to communicate with the wireless network

In order to communicate with the Gateway, and ultimately the Information System, the transmitter must be configured to communicate with the wireless network. This step is the wireless equivalent of connecting wires from a transmitter to the information system. Using a Field Communicator or AMS Wireless Configurator, enter the Network ID and Join Key so that they match the Network ID and Join Key of the gateway and other devices in the network. If the Network ID and Join Key are not identical, the Rosemount 702 Transmitter will not communicate with the network. The Network ID and Join Key may be obtained from the Emerson Wireless Gateway on the *Setup>Network>Settings* page on the web server, shown in Figure 4-1.

Figure 4-1. Gateway Network Settings

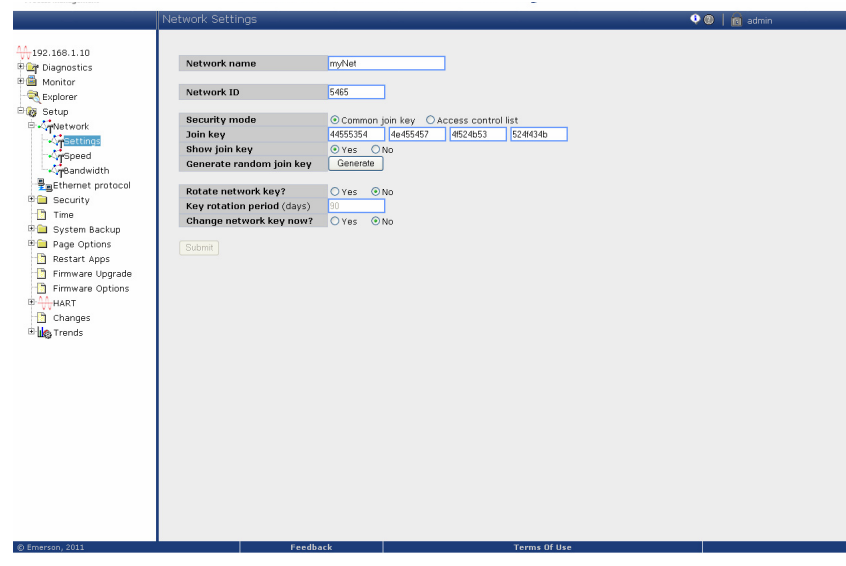

## 4.3 AMS Wireless Configurator

Right click on the Rosemount 702 Transmitter and select **Configure**. When the menu opens, select **Join Device to Network** and follow the method to enter the Network ID and Join Key.

## 4.4 Field Communicator

The Network ID and Join Key may be changed in the wireless device by using the following Fast Key sequence. Set both Network ID and Join Key.

Function	Key Sequence	Menu Items
Wireless Setup	2, 1, 1	Network ID, Set Join Key

## 4.5 Verifying operation

There are four ways to verify operation: using the optional local display (LCD), using the Field Communicator, using the Gateway's integrated web interface, or by using AMS Suite Wireless Configurator. If the Rosemount 702 Transmitter was configured with the Network ID and Join Key, and sufficient time has passed, the transmitter will be connected to the network.

### Troubleshooting

If the device is not joined to the network after power up, verify the correct configuration of the Network ID and Join Key, and verify that Active Advertising has been enabled on the Gateway. The Network ID and Join Key in the device must match the Network ID and Join Key of the Gateway.

### Operating the local display

The LCD displays the PV and SV values at the configured update rate, but no faster than once every 60 seconds.

### Diagnostic button display sequence

More detailed diagnostic information can be obtained by removing the display cover of the Rosemount 702 Transmitter, and momentarily depressing the "DIAG" button. The LCD will display the diagnostic screens as shown in Figure 4-3.

Press the Diagnostic button to display the TAG, Device ID, Network ID, Network Join Status and Device Status screens.

Figure 4-2. Diagnostic Screen Sequence

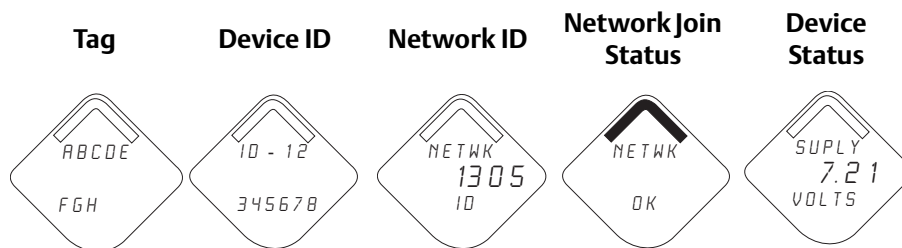

### Network join status

The chevron-shaped status bar at the top of the screen indicates the progress of the network join process. When the status bar is filled, the device is successfully connected to the wireless network. This is shown, in Figure 4-3 on page 30.

Figure 4-3. Network Join Status Screens

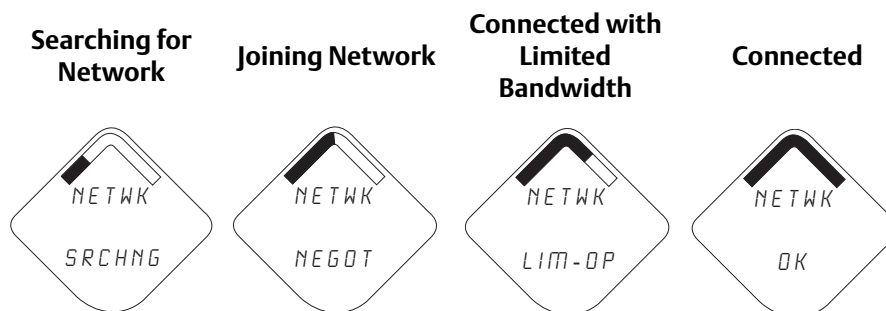

## Connecting with a Field Communicator

A Rosemount 702 DD is required for HART communication. For connecting with a Field Communicator, refer to [Figure 2-3 on page 10](#).

Function	Key Sequence	Menu Items
Communications	3,3	Join Status, Communication Status, Join Mode, Number of Available Neighbors, Number of Advertisements Heard, Number of Join Attempts

## Checking for communication using the Gateway

In the integrated web interface from the Gateway, navigate to the Explorer page. This page shows whether the device has joined the network and if it is communicating properly.

### Note

The time to join the new device(s) to the network is dependent upon the number of devices being joined and the number of devices in the current network. For one device joining an existing network with multiple devices, it may take up to five minutes. It may take up to 60 minutes for multiple new devices to join the existing network.

## Alarm configuration

if the device joins the network and immediately has an alarm present, it is likely due to sensor configuration. Check the sensor wiring (see [“Terminal Block” on page 9](#)) and the sensor configuration (see [“Fast Key sequence” on page 13](#)).

Figure 4-4. Gateway Explorer Page

HART Tag	HART status	Last update	PV	SV	TV	QV	Burst rate
2160_Level	●	04/20/11 18:09:53	0.000	1394.483 Hz	23.000 DegC	7.502 V	8
3051S_Pressure	●	04/20/11 18:09:55	-0.027 InH2O 68F	22.750 DegC	22.750 DegC	7.115 V	8
6081_Conductivity	●	04/20/11 18:09:42	9.795 pH	23.322 DegC		7.283 V	16
6081_pH	●	04/20/11 18:09:50	9.803 pH	22.822 DegC	-165.002 mV	7.287 V	16
648_Temperature	●	04/20/11 18:09:55	22.859 DegC	NaN DegC	22.500 DegC	7.116 V	8
4320_Position	●	04/20/11 18:09:57	1.000 %	1.000	0.000	23.000 DegC	4
702_Discrete	●	04/20/11 18:09:53	1.000	0.000	23.250 DegC	7.063 V	8
848_Temperature	●	04/20/11 18:09:35	22.850 DegC	22.822 DegC	22.822 DegC	24.861 DegC	32
9420_Vibration	●	04/20/11 17:25:22	0.023 in/s	0.022 g/s	2.501 V	7.143 V	01:00:00
248_Temperature	●	04/20/11 18:09:55	22.959 DegC	NaN DegC	22.550 DegC	7.116 V	16
708_Acoustic	●	04/20/11 18:09:54	6.378 Counts	24.559 DegC	22.550 DegC	3.391 V	16

## 4.5.1 AMS Wireless Configurator

When the device has joined the network, it will appear in the Device Manager as illustrated below:

Tag	Manufacturer	Device Type	Device Rev	Protocol	Protocol Rev
02/03/2009 11:20:00.937	Rosemount	3051S WirelessHART	1	HART	7
02/03/2009 11:32:35.873	Rosemount	648 WirelessHART	1	HART	7
05/11/2011 09:00:15.377	Rosemount	702 Discrete Transmitter	3	HART	7

## Troubleshooting

If the device is not joined to the network after power up, verify the correct configuration of the Network ID and Join Key, and verify that Active Advertising has been enabled on the Gateway. The Network ID and Join Key in the device must match the Network ID and Join Key of the Gateway.

The Network ID and Join Key may be obtained from the Gateway on the *Setup>Network>Settings* page on the web interface (see [Figure 4-4 on page 31](#)). The Network ID and Join Key may be changed in the wireless device by using the following Fast Key sequence.

Function	Key Sequence	Menu Items
Wireless	2,1,1	Join Device to Network





# Section 5      Operation and Maintenance: Models 702DX22 and 702DX61

---

Safety Messages .....	page 33
Discrete input from switches and sensors .....	page 34
LCD display screen messages .....	page 40
Replacing the power module .....	page 48
Service support .....	page 49

---

## 5.1      Safety Messages

Instructions and procedures in this section may require special precautions to ensure the safety of the personnel performing the operations. Information that potentially raises safety issues is indicated by a warning symbol (⚠). Refer to the following safety messages before performing an operation preceded by this symbol.

### **⚠ WARNING**

**Failure to follow these installation guidelines could result in death or serious injury.**

Make sure only qualified personnel perform the installation.

**Explosions could result in death or serious injury.**

- Before connecting a Field Communicator in an explosive atmosphere, make sure the instruments are installed in accordance with intrinsically safe or non-incendive field wiring practices.
- Verify that the operating atmosphere of the transmitter is consistent with the appropriate hazardous locations certifications.

**Process leaks could result in death or serious injury.**

- Do not remove the switch while in operation.
- Install and tighten sensors before applying pressure.

**Electrical shock could cause death or serious injury.**

Use extreme caution when making contact with the leads and terminals.

---

## 5.2 Discrete input from switches and sensors

### 5.2.1 Dry contact inputs, measurement option code 22 (702DX22)

Figure 5-1. Terminal Diagram

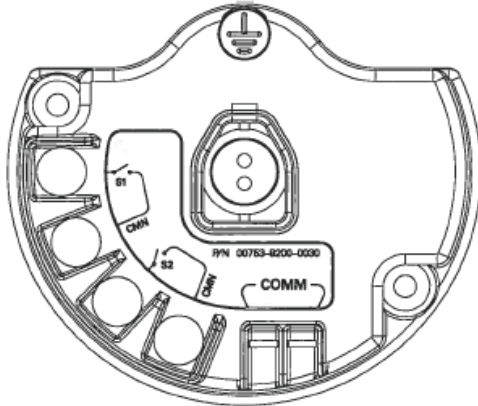

### 5.2.2 Wireless output specifications

#### Dual input

The Rosemount™ 702 Wireless Discrete Transmitter will accept the input from one or two single pole single throw switches on inputs S1 and S2. The wireless output of the transmitter will be both a primary variable (PV) and a secondary variable (SV). The PV is determined by the S1 input. The SV is determined by the S2 input. A closed switch drives a TRUE output. An Open switch drives a FALSE output.

#### Note

Any dry contact input can be inverted by the device, so as to give the opposite effect. This is useful, for instance, if a normally open switch is used to replace a normally closed switch.

Figure 5-2. Single and Dual Input

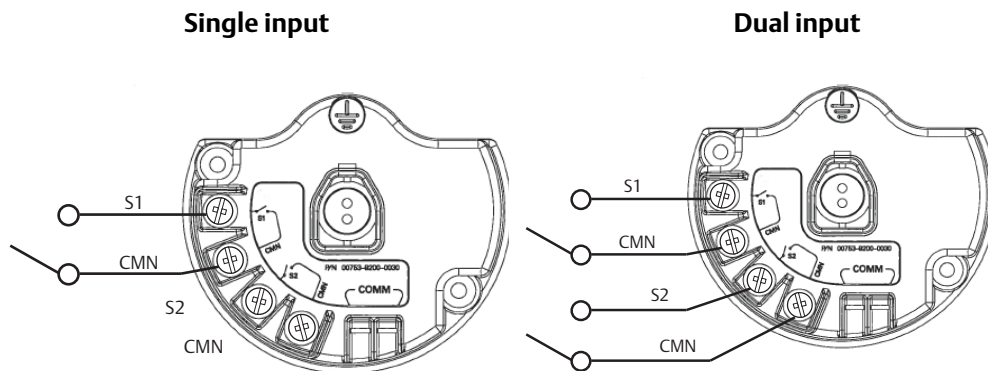

Switch input	Wireless output	Switch input	Wireless output
<b>S1</b>	<b>PV</b>	<b>S2</b>	<b>SV</b>
Closed	TRUE (1.0)	Closed	TRUE (1.0)
Open	FALSE (0.0)	Open	FALSE (0.0)

### Dual input, limit contact logic

When configured for limit contact logic, the Rosemount 702 Transmitter will accept the input from two single pole single throw switches on inputs S1 and S2, and will use limit contact logic for the determination of the wireless outputs. The following tables describe the wireless outputs available when using limit contact logic.

Figure 5-3. Dual Input, Limit Contacts

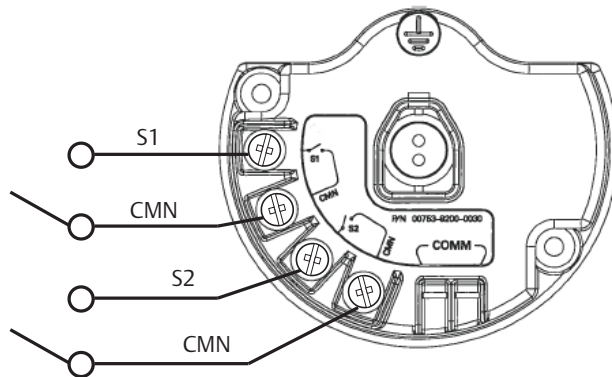

Switch inputs		Wireless outputs	
S1	S2	PV	SV
Open	Open	TRAVEL (0.5)	TRAVEL (0.5)
Open	Closed	FALSE (0.0)	FALSE (0.0)
Closed	Open	TRUE (1.0)	TRUE (1.0)
Closed	Closed	FAULT(NaN)	FAULT(NaN)

### Dual input, opposing contact logic

When configured for Opposing Contact Logic, the Rosemount 702 Transmitter will accept the input from a single pole double throw switch on inputs S1 and S2, and will use opposing contact logic for the determination of the wireless outputs. The following tables describe the wireless outputs available when using opposing contact logic.

**Figure 5-4. Dual Input, Opposing Contact**

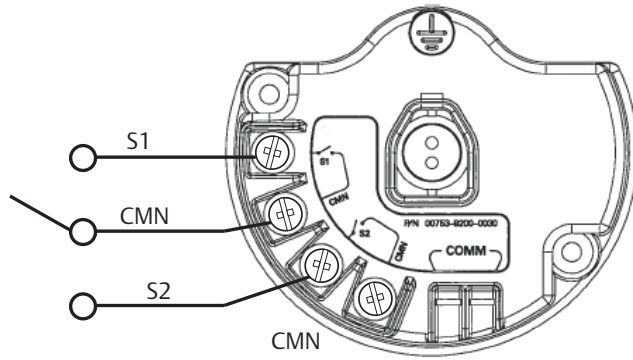

Switch inputs		Wireless outputs	
S1	S2	PV	SV
Open	Open	FAULT(NaN)	FAULT(NaN)
Open	Closed	FALSE (0.0)	FALSE (0.0)
Closed	Open	TRUE (1.0)	TRUE (1.0)
Closed	Closed	FAULT(NaN)	FAULT(NaN)

### 5.2.3 Liquid hydrocarbon detection, measurement option code 61 (702DX61)

**Figure 5-5. Fuel Sensor Terminal**

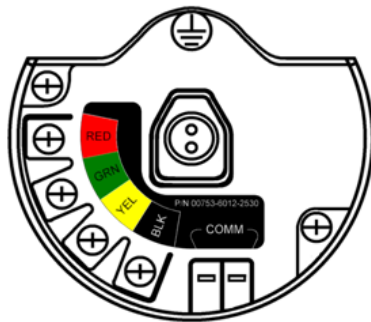

The Liquid Hydrocarbon Detection configuration is intended for use with the Tyco® TraceTek® Fast Fuel Sensor, or TraceTek Sensing cable.

Figure 5-6. Fuel Sensor Connection

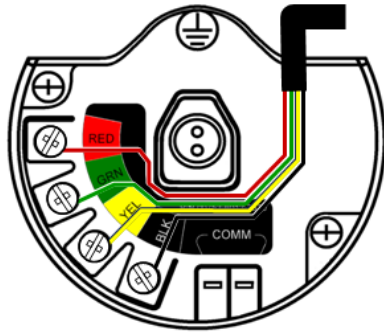

## Connecting the transmitter to the Fast Fuel Sensor and TraceTek Sensing Cable

The connections to the Fast Fuel Sensor TraceTek sensing cable are made by matching the appropriately colored wires to the matching colored termination lugs.

- The Rosemount 702 Transmitter can support up to three Fast Fuel Sensors. These sensors are connected using TraceTek Modular Leader Cable (TT-MLC-MC-BLK), optional modular jumper cables (TT-MJC-xx-MC-BLK) and branching connectors (TT-ZBC-MC-BLK) as suggested in [Figure 3-11](#) on page 22.

## Using the AMS Device Manager with the liquid hydrocarbon detection option

The following figures show how the AMS Device Manager overview screen looks for the Rosemount 702 Transmitter with liquid hydrocarbon detection option, for each of the leak sensor conditions:

Figure 5-7. Normal Status

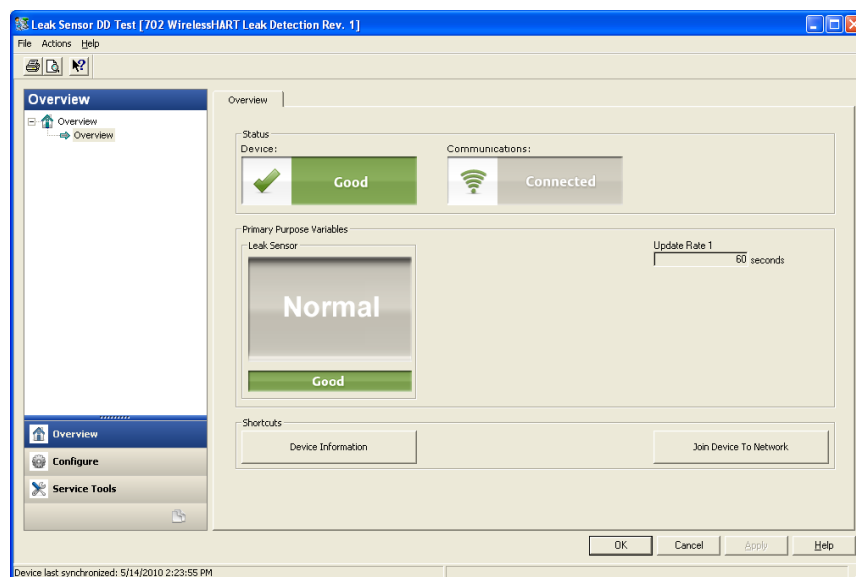

Figure 5-8. Leak Status

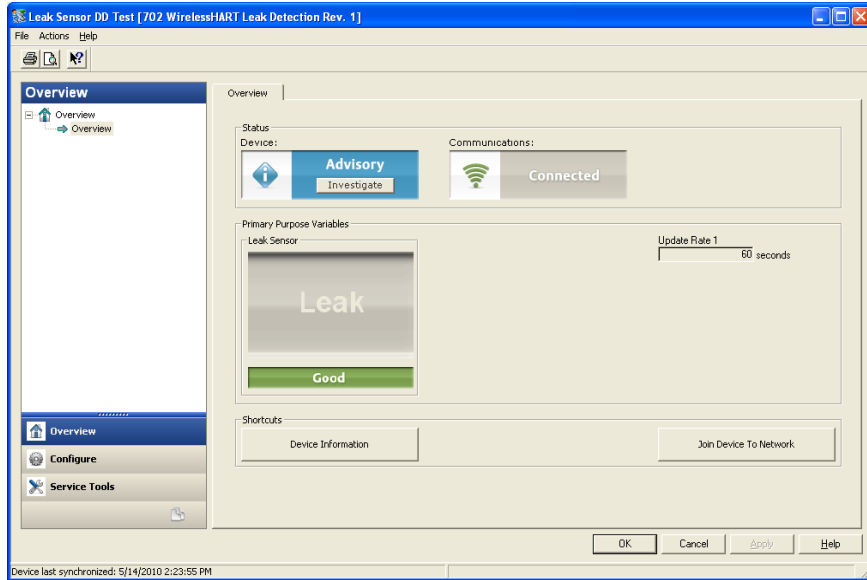

Figure 5-9. Leak Sensor Not Connected Status

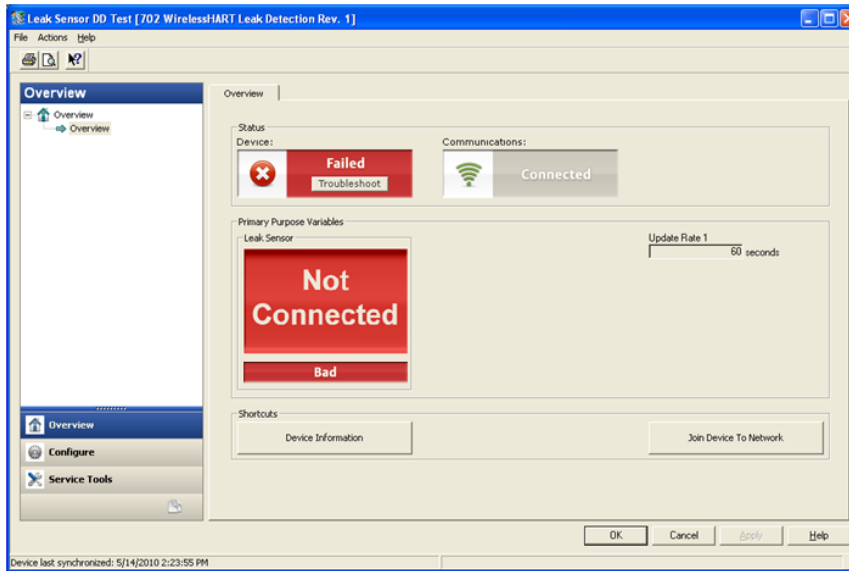

Table 5-1. Liquid Hydrocarbon Detection Interface, for Modbus® mapping

PV	SV	Description/interpretation
1.0	1.0	Normal condition, no leak detected, sensor status good
0.0	1.0 or 0.0	Leak detected, sensor status good
1.0	0.0	Sensor Not Connected, Assume Leak, take appropriate action

Table 5-1 describes use of the Rosemount 702 Transmitter for hydrocarbon detection in other communications protocols such as Modbus or OPC. It is imperative that both PV and SV be mapped to the host system so as to make a good interpretation of the condition and status of the leak detector.

**Note**

It is imperative that both PV and SV be mapped to the host system so that the diagnostic information on the sensor status is captured.

In addition, system considerations must be observed to ensure that the device is still connected to the wireless network and reporting values. On an Emerson Wireless Gateway, this can be done by referring to the parameter: PV\_HEALTHY. PV\_HEALTHY has a “True” state when the device is on the network and its updates are current, not late or stale, and the device is functioning properly. A “False” state of PV\_HEALTHY means that the device is either off of the network, the data updates are not current, or that there is a malfunction of the device (such as an electronics failure). In the case of a “False” state of PV\_HEALTHY, it is recommended to assume that the device is not connected to the network and to take appropriate action.

**Mapping the PV, SV, and PV\_HEALTHY Variables and Parameter**

Below is a shot of the Gateway screen where the PV, SV and PV\_HEALTHY variables and parameter can be mapped.

**Figure 5-10. Gateway Modbus Register Map**

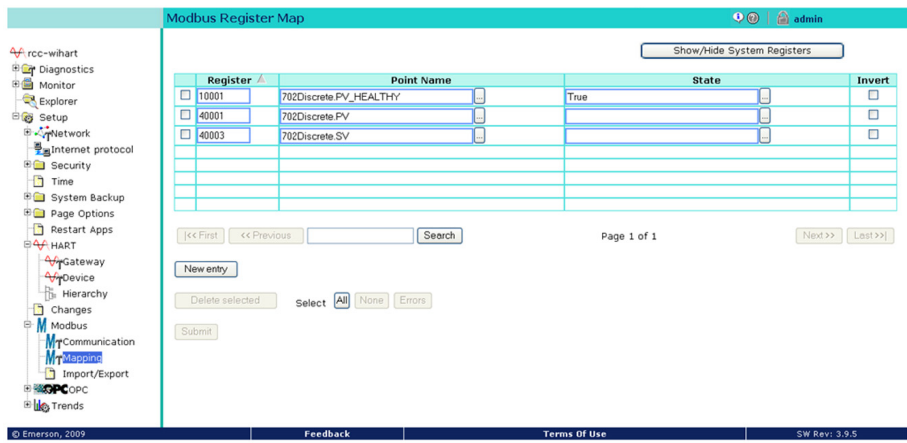

- The Fast Fuel Sensor Diagnostics will propagate via the SV variable. This additional information will provide additional sensor Status information while using the TraceTek Fast Fuel Sensor.
- Warning: If a device becomes not present on the wireless network, Appropriate action must be taken by the host system.

Important notes regarding the use of Tyco TraceTek Fast Fuel Sensor and TraceTek Sensing cable:

- Tyco TraceTek sensors must be installed as per manufacturer recommendations.
- Do not run the Rosemount 702 Transmitter for long periods (more than two weeks) with a Tyco fuel sensor in the leak state as this will more rapidly deplete the power module.

## 5.3 LCD display screen messages

### Note

Dry Contact Inputs only, Measurement Option Code 22. LCD is not available for Liquid Hydrocarbon Detection, Measurement Option Code 61.

### 5.3.1 Startup screen sequence

The following screens will display when the power module is first connected to the Rosemount 702 Transmitter:

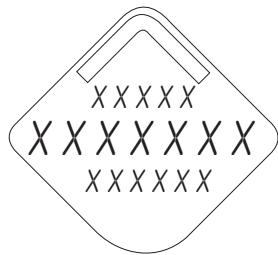

1. All Segments On: used to visually determine if there are any bad segments on the LCD

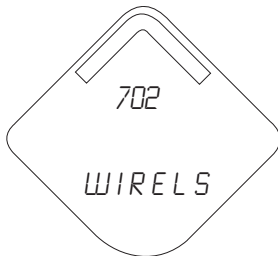

2. Device Identification: used to determine Device Type.

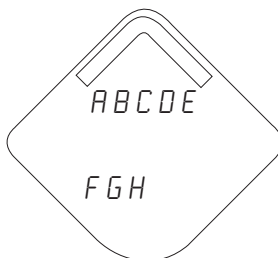

3. Device Information - Tag: user entered tag which is eight characters long - will not display if all characters are blank

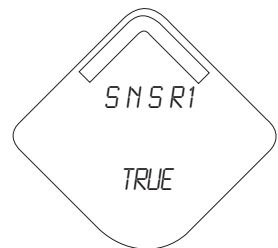

4. PV Screen - Discrete input 1 or logic output value depending on how the device is configured



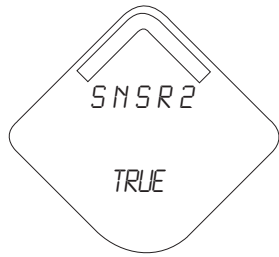

5. SV Screen - Discrete input 2



6. TV Screen - feature board temperature value

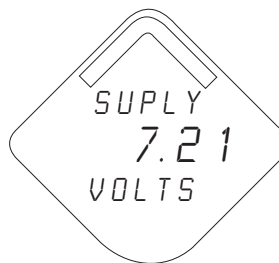

7. QV Screen - voltage reading at the power module terminals

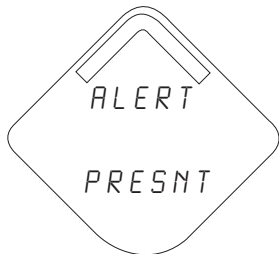

8. Alert Screen - at least one alert is present - this screen will not display if no alerts are present

### 5.3.2 Diagnostic button screen sequence

The following five screens will display when the device is operating properly and the Diagnostic Button has been pressed:

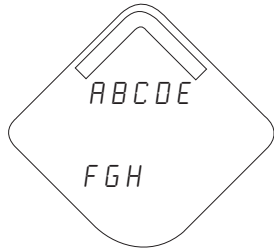

1. Device Information - Tag: user entered tag which is eight characters long - will not display if all characters are blank

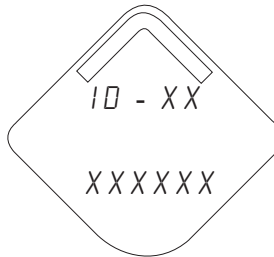

2. Device Identification: used to determine Device ID

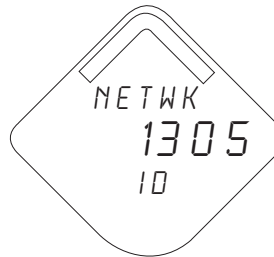

3. Network ID: assuming the device has the correct join key, this ID tells the user what network the device can connect with



4. Network Connection Status: the device has joined a network and has been fully configured and has multiple parents

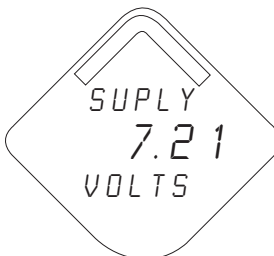

5. Supply Voltage: voltage reading at the power module terminals

### 5.3.3 Network connection status screens

These screens display the network status of the device. Only one will be shown in the fourth position of the diagnostic button screen sequence.

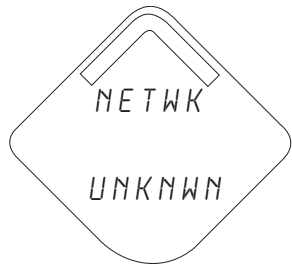

1. Diagnostic Button Screen 4.1: the device is attempting to start the radio

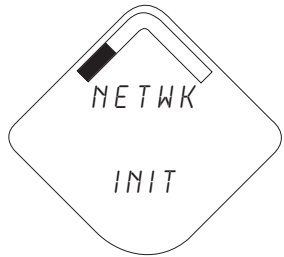

2. Diagnostic Button Screen 4.2: the device has just restarted

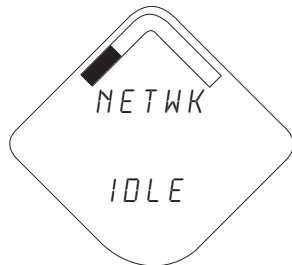

3. Diagnostic Button Screen 4.3: the device is starting to join the process

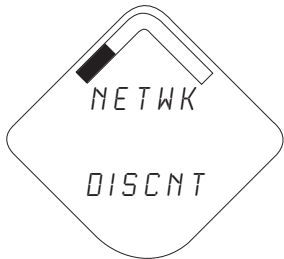

4. Diagnostic Button Screen 4.4: the device is in a disconnected state and requires a "Force Join" command to join the network

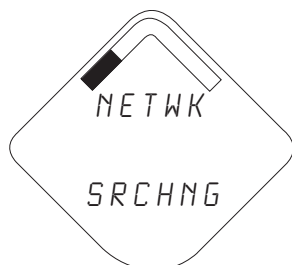

5. Diagnostic Button Screen 4.5: the device is searching for the Network

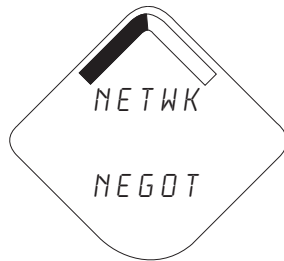

6. Diagnostic Button Screen 4.6: the device is attempting to join a network

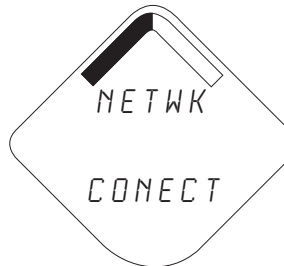

7. Diagnostic Button Screen 4.7: the device is connected to the Network, but is in a “Quarantined” state

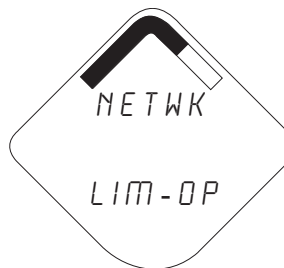

8. Diagnostic Button Screen 4.8: the device is joined and operational, but is running with limited bandwidth for sending periodic data



9. Diagnostic Button Screen 4.9: the device has joined a network and has been fully configured and has multiple parents

### 5.3.4 Device diagnostic screens

The following screens will show the device diagnostics depending on the state of the device and will appear after screen 5 of the Diagnostic Button Screen Sequence.

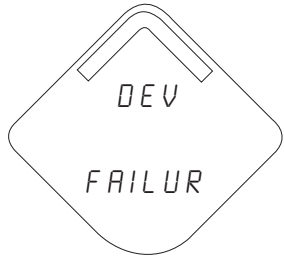

1. Device Information - Status: there is a critical error which may prevent the device from operating correctly. Check additional status screens for more information.

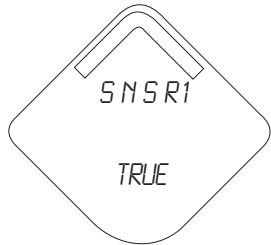

2. PV Screen - Discrete input 1 or logic output value depending on how the device is configured

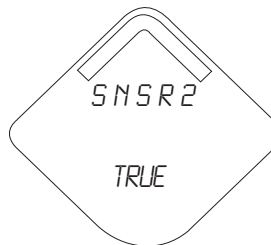

3. SV Screen - Discrete input 2



4. TV Screen - feature board temperature value

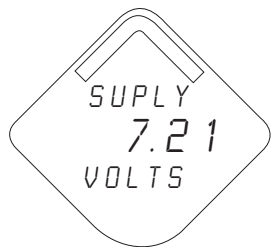

5. QV Screen - voltage reading at the power supply terminals

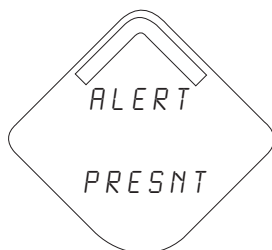

6. Alert Screen - at least one alert is present - this screen will not display if no alerts are present

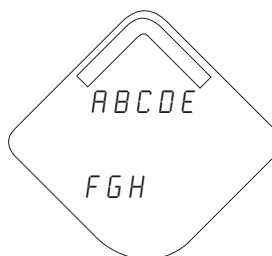

7. Diagnostic Button Screen 1 - Tag: user entered tag which is eight characters long - will not display if all characters are blank

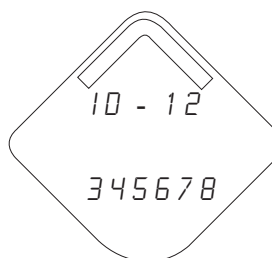

8. Diagnostic Button Screen 2: the device's identifier that is used to make up the HART long address - the Rosemount 1420 Wireless Gateway may use this to help identify devices if no unique user tag is available

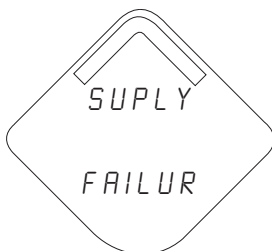

9. Diagnostic Button Screen 7.1: the terminal voltage has dropped below level of operating limit. Replace the power module (Part Number: 00753-9220-0001)

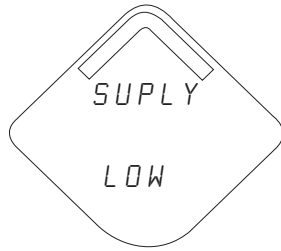

10. Diagnostic Button Screen 7.2: the terminal voltage is below the recommended operating range - if this is a self-operated device, the power module should be replaced - for line powered devices, the supply voltage should be increased



11. Diagnostic Button Screen 8: the device cannot retrieve information from the radio in the device - the device may still be operational and publishing HART data

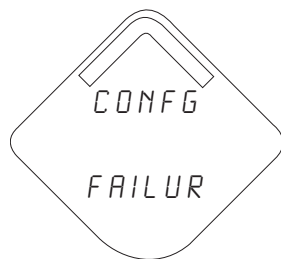

12. Diagnostic Button Screen 9.1: configuration of the transmitter is invalid such that critical operation of the device may be affected - check the extended configuration status to identify which configuration item(s) need to be corrected



13. Diagnostic Button Screen 9.2: configuration of the transmitter is invalid such that non-critical operation of the device may be affected - check the extended configuration status to identify which configuration item(s) need to be corrected

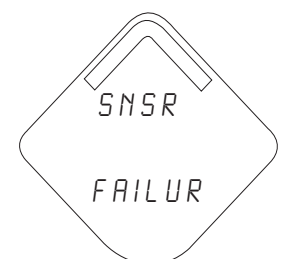

14. Diagnostic Button Screen 10.1: a switch attached to the transmitter has failed, and valid readings from that switch are no longer possible - check the switch and switch wiring connections - check additional status for more detailed information of the failure source

---

**Note**

Use Rosemount wireless LCD display part number: 00753-9004-0002.

---

## 5.4 Replacing the power module

Expected power module life is ten years at reference conditions.<sup>(1)</sup>

When the power module needs to be replaced, remove the power module cover and the depleted power module. Replace the power module with a new Black Power Module, SmartPower™ Solutions model number 701PBKKF (part number 00753-9220-0001). Then replace the cover and tighten it to specification. Always ensure a proper seal so that metal touches metal, but do not overtighten.

### Handling the power podule

The Black Power Module with the wireless unit contains two “C” size primary lithium/thionyl chloride batteries. Each battery contains approximately 2.5 grams of lithium, for a total of 5 grams in each pack. Under normal conditions, the battery materials are self-contained and are not reactive as long as the batteries and the battery pack integrity are maintained. Care should be taken to prevent thermal, electrical or mechanical damage. Contacts should be protected to prevent premature discharge.

Use caution when handling the power module, it may be damaged if dropped from heights in excess of 20 ft.

 Battery hazards remain when cells are discharged.

### Environmental considerations

As with any battery, local environmental rules and regulations should be consulted for proper management of spent batteries. If no specific requirements exist, recycling through a qualified recycler is encouraged. Consult the materials safety data sheet for battery specific information.

### Shipping considerations

The unit was shipped to you without the power module installed. Remove the power module prior to shipping.

Each power module contains two “C” size primary lithium batteries. Primary lithium batteries are regulated in transportation by the U.S. Department of Transportation, and are also covered by International Air Transport Association (IATA), International Civil Aviation Organization (ICAO), and European Ground Transportation of Dangerous Goods (ARD). It is the responsibility of the shipper to ensure compliance with these or any other local requirements. Consult current regulations and requirements before shipping.

1. Reference conditions are 70 °F (21 °C), wireless update of once per minute, and routing data for three additional network devices.



## 5.5 Service support

To expedite the return process outside of North America, contact your Emerson™ representative,

Within the United States, call the Emerson Response Center toll-free number 1 800 654 7768. The center, which is available 24 hours a day, will assist you with any needed information or materials.

The center will ask for product model and serial numbers, and will provide a Return Material Authorization (RMA) number. The center will also ask for the process material to which the product was last exposed.

### **⚠ CAUTION**

Individuals who handle products exposed to a hazardous substance can avoid injury if they are informed of, and understand, the hazard. If the product being returned was exposed to a hazardous substance as defined by OSHA, a copy of the required Material Safety Data Sheet (MSDS) for each hazardous substance identified must be included with the returned goods.



---

# Section 6 Configuration: Models 702DX32 and 702DX42

---

---

Safety messages .....	page 51
Discrete channel configuration .....	page 52
Device network configuration .....	page 52
HART menu tree .....	page 55
Removing the power module .....	page 58

---

## 6.1 Safety messages

Instructions and procedures in this section may require special precautions to ensure the safety of the personnel performing the operations. Information that potentially raises safety issues is indicated by a warning symbol (⚠). Refer to the following safety messages before performing an operation preceded by this symbol.

### **⚠ WARNING**

**Failure to follow these installation guidelines could result in death or serious injury.**

Only qualified personnel should perform the installation.

**Explosions could result in death or serious injury.**

- Before connecting a Field Communicator in an explosive atmosphere, make sure that the instruments are installed in accordance with intrinsically safe or non-incendive field wiring practices.
- Verify that the operating atmosphere of the transmitter is consistent with the appropriate hazardous locations certifications.

**Process leaks could result in death or serious injury.**

- Do not remove the switch while in operation.
- Install and tighten switches before applying pressure.

**Electrical shock could cause death or serious injury.**

Use extreme caution when making contact with the leads and terminals.

---

## 6.1.1 Ensuring proper switch connections

The Rosemount™ 702 Wireless Discrete Transmitter is compatible with a number of simple switches. When ordered in the optional configuration for Liquid Hydrocarbon Detection, option code 61, the transmitter is compatible with Tyco® TraceTek® Fast Fuel Sensors and TraceTek sensing cable. [Figure 6-1 on page 53](#) shows the correct input connections to the switch terminals on the transmitter. To ensure a proper switch connection, anchor the switch lead wires into the appropriate compression terminals and tighten the screws.

### Switch leads

 If the switch is installed in a high-voltage environment and a fault condition or installation error occurs, the sensor leads and transmitter terminals could carry lethal voltage. Use extreme caution when making contact with the leads and terminals.

### Wiring the sensor and power supply to the transmitter

Use the following steps to wire the sensor and power supply to the transmitter:

1. Remove the transmitter enclosure cover (if applicable).
2. Attach the sensor leads according to the wiring diagram [Figure 2-2 on page 10](#).
3. Connect the power module.
4. Verify the connection by viewing the LCD display.
5. Replace the cover and tighten (if applicable).

## 6.2 Discrete channel configuration

Remove the power module-side housing cover to expose the terminal block and HART communication terminals, then connect the power module to power the unit for configuration.

The Rosemount 702 Transmitter will receive any HART Communication from a Field Communicator, or AMS Wireless Configurator. When using a Field Communicator, any configuration changes must be sent to the transmitter using the Send key (F2). AMS Wireless Configurator configuration changes are implemented when the Apply button is clicked.

### Configuring on the bench with a HART modem

AMS Wireless Configurator is capable of connecting to devices directly, using a HART® modem, or with the Gateway. When configuring on the bench with a HART modem, double click the device icon, then choose the **Configure/Setup tab** (or right click and select **Configure/Setup**). Configure the device settings using the Direct Connection menu. When configuring with the Gateway, double click the device icon then choose the **Configure/Setup tab** (or right click and select **Configure/Setup**). Configure the device settings using the Wireless Connection menu.

To check or change discrete channel configuration using a Field Communicator, enter the following Fast Key Sequence: 2, 2, 2.

## 6.3 Device network configuration

To communicate with the Gateway, and ultimately the Information System, the transmitter must be configured to communicate with the wireless network.

## Entering the network ID and join key

Using a Field Communicator or AMS Wireless Configurator, enter the Network ID and Join Key so they match the Network ID and Join Key of the Gateway and the other devices in the network. If the Network ID and Join Key are not identical, the transmitter will not communicate with the network. The Network ID and Join Key may be obtained from the Gateway on the *setup>network>settings* page on the web server. Using a Field Communicator, the Network ID can be configured by entering the Fast Key Sequence: 2, 2, 1, 1. The Join Key can also be configured using a Field Communicator with the Fast Key Sequence: 2, 2, 1, 2.

## Changing the update rate with a Field Communicator

The final device network configuration piece is the update rate which, by default, is 1 minute. It can be changed at commissioning, or at any time, by using AMS Wireless Configurator or the Emerson™ Wireless Gateway's web server. The Update Rate should be between one second and 60 minutes. To change the update rate with a Field Communicator, use the Fast Key Sequence: 2, 2, 1, 3.

## Configuring on the bench

If doing a bench top initial configuration, after completion remove the power module until installation. When the device is installed, insert the power module and close the housing cover securely. Always ensure a proper seal so that metal touches metal, but do not overtighten.

### 6.3.1 Dry contact inputs, measurement option code 32, 42 (Models 702DX32 and 702DX42)a

Figure 6-1. Terminal Block

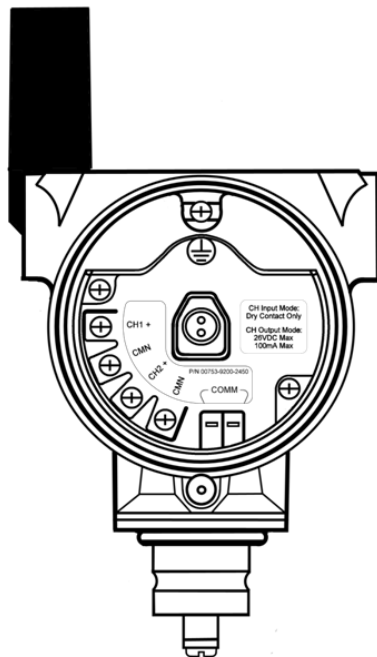

Connect the HART communication leads to the COMM terminals on the terminal block.

Figure 6-2. Field Communicator Connections

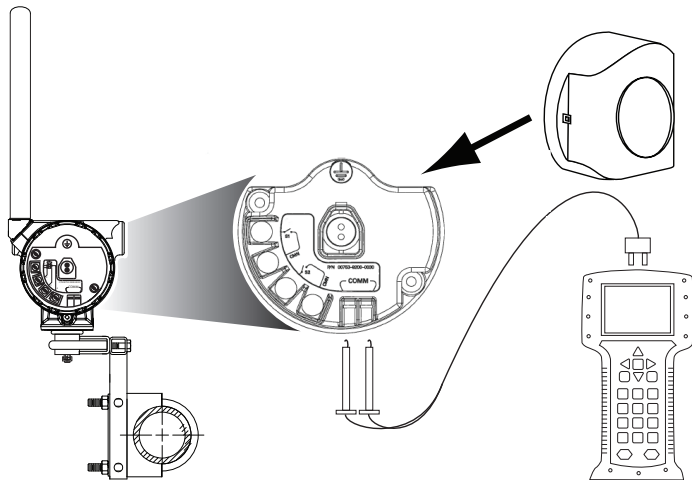

For HART communication, a Rosemount 702 DD is required.

## 6.4 HART menu tree

For ease of operation, changing setup, such as switch type, can be completed in several locations.

Figure 6-3. Overview

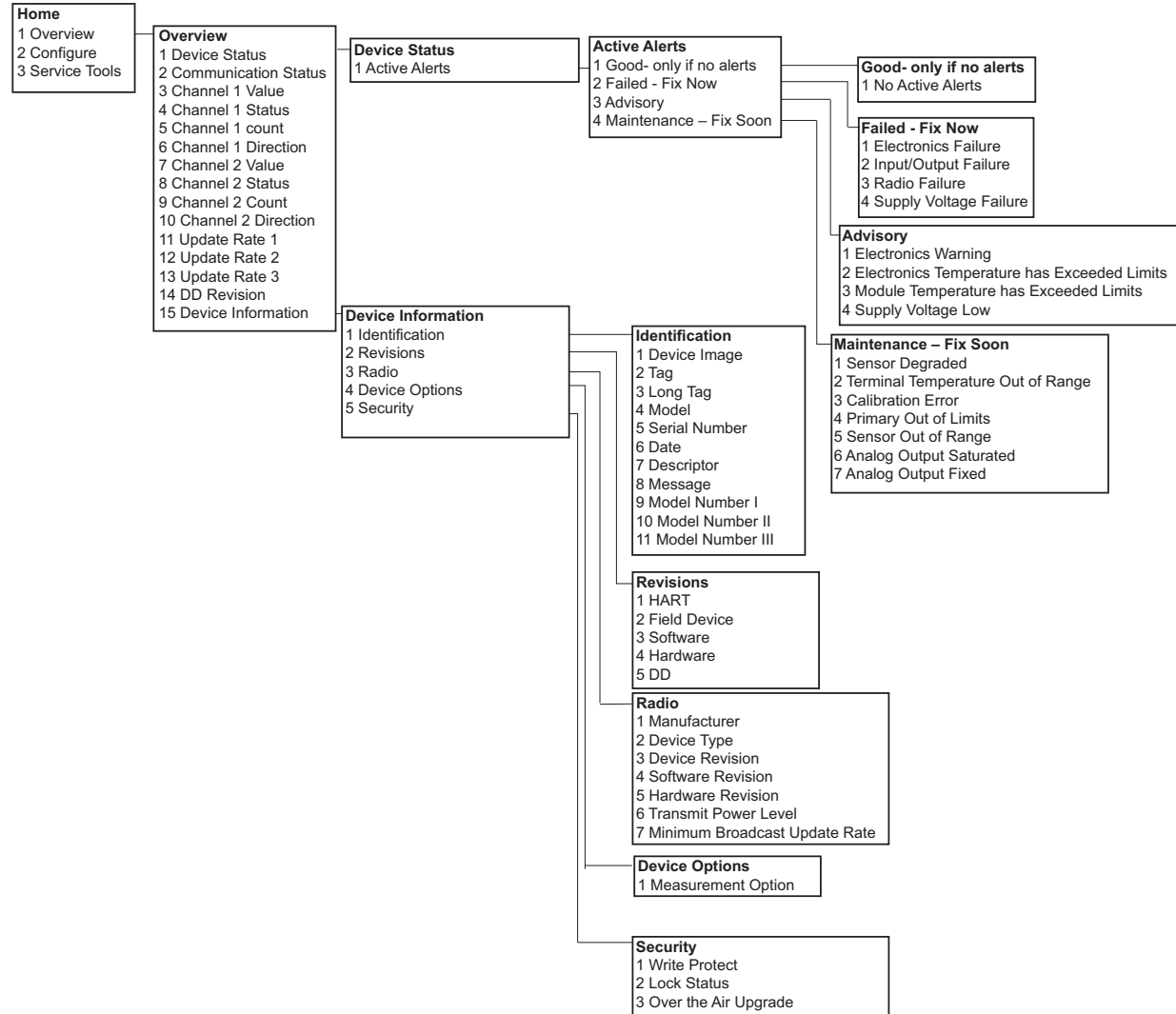

Figure 6-4. Configure

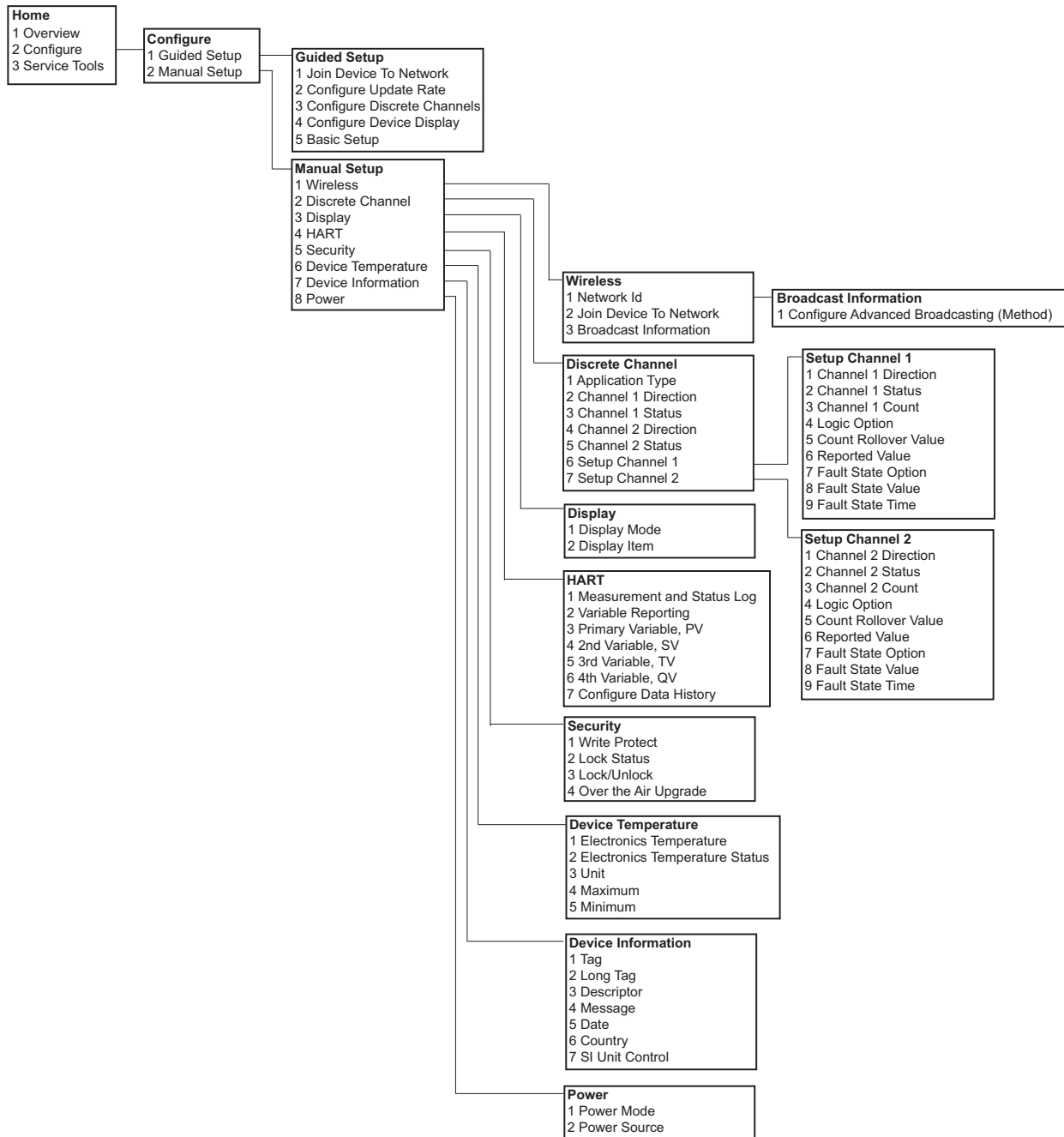
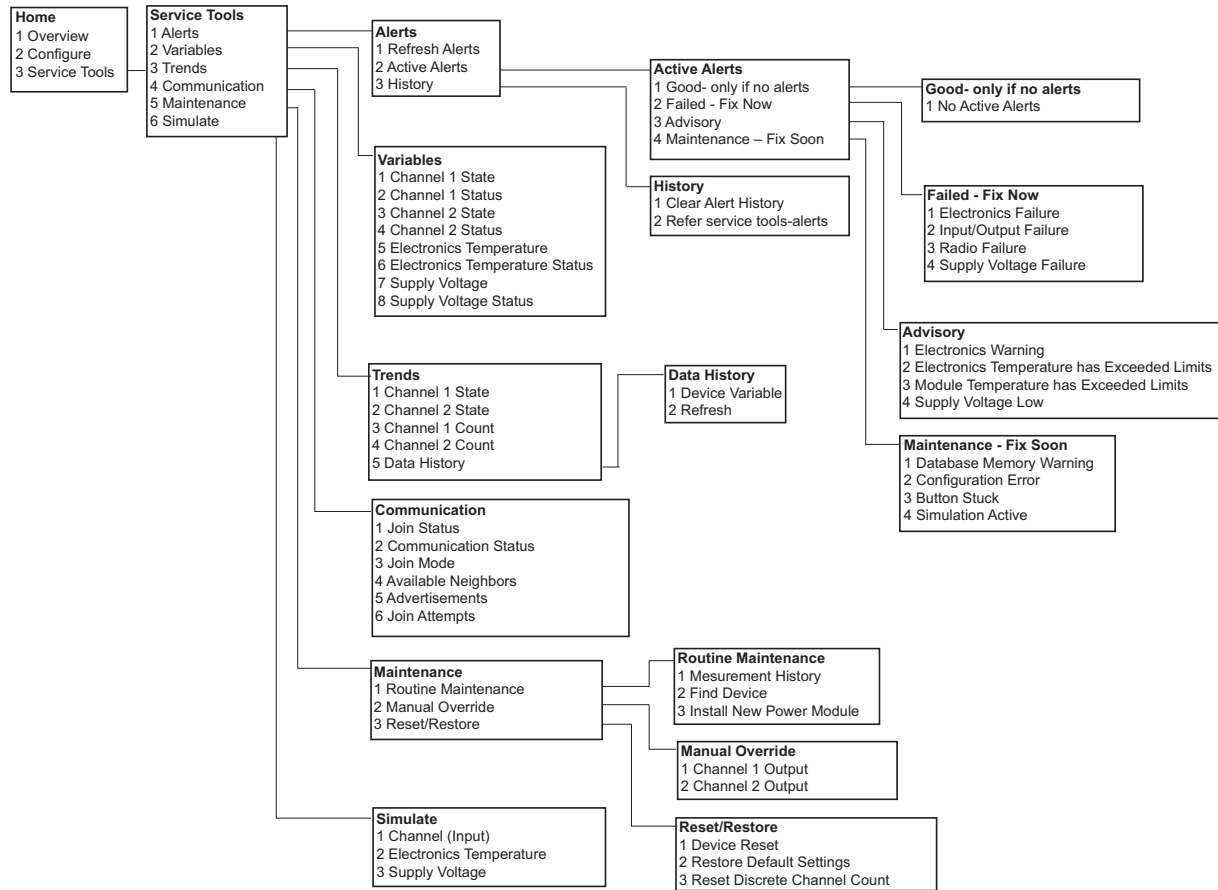



Figure 6-5. Service Tools



## 6.4.1 Fast Key sequence

Table 6-1 lists the Fast Key sequence for common transmitter functions.

### Note

The Fast Key sequences assume that a current DD is being used: DD Rev 2 for dry contact inputs, and DD Rev 1 for leak detection.

**Table 6-1. Fast Key Sequence**

Function	Key Sequence	Menu Items
Device Information	1, 15	Manufacturer, Model, Final Assembly Number, Universal, Field Device, Software, Hardware Descriptor, Message, Date, Model Number, I, II, III, SI Unit Restriction, Country
Guided Setup	2, 1	Join Device to Network, Configure Update Rate, Configure Sensor, Calibrate Sensor, Configure Display, Configure Process Alarms
Manual Setup	2, 2	Wireless, Process Sensor, Percent of Range, Device Temperature, Device Information, Device Configure, Other
Wireless	2, 2, 1	Network ID, Join Device to Network, Configure Update Rate, Configure Broadcast Power Level, Power Mode, Power Source
Discrete Channel Configuration	2, 2, 2	Discrete Channel Configuration

## 6.5 Removing the power module

After the sensor and network have been configured, remove the power module and replace the transmitter cover. The power module should be inserted only when the device is ready for commissioning.

# Section 7 Mounting, Wiring Switches, and Output Circuits: Models 702DX32 and 702DX42

---

Safety messages .....	page 59
Installing the transmitter .....	page 60
Wiring switches and sensors .....	page 63
LCD display .....	page 70
Grounding the transmitter .....	page 71

---

## 7.1 Safety messages

Instructions and procedures in this section may require special precautions to ensure the safety of the personnel performing the operations. Information that potentially raises safety issues is indicated by a warning symbol (⚠). Refer to the following safety messages before performing an operation preceded by this symbol.

### **⚠ WARNING**

#### **Failure to follow these installation guidelines could result in death or serious injury.**

Only qualified personnel should perform the installation.

#### **Explosions could result in death or serious injury.**

- Before connecting a Field Communicator in an explosive atmosphere, make sure that the instruments are installed in accordance with intrinsically safe or non-incendive field wiring practices.
- Verify that the operating atmosphere of the transmitter is consistent with the appropriate hazardous locations certifications.

#### **Process leaks could result in death or serious injury.**

- Do not remove the switch while in operation.
- Install and tighten switches before applying pressure.

#### **Electrical shock could cause death or serious injury.**

- Use extreme caution when making contact with the leads and terminals.
  - This device complies with Part 15 of the FCC Rules. Operation is subject to the following conditions: This device may not cause harmful interference. This device must accept any interference received, including interference that may cause undesired operation.
  - This device must be installed to ensure a minimum antenna separation distance of 20 cm from all persons.
-

## 7.2 Installing the transmitter

The Rosemount™ 702 Wireless Discrete Transmitter can be installed in one of two configurations:

**Direct mount:** The switch is connected directly to the Rosemount 702 Transmitter housing's conduit entry. For installation instructions see [“Direct mount” on page 60](#).

**Remote mount:** The switch is mounted separate from the Rosemount 702 Transmitter housing, then connected to the transmitter via conduit. For installation instructions see [“Remote mount” on page 62](#). Use Remote mount instructions for the installation of liquid hydrocarbon sensors.

### 7.2.1 Direct mount

1. Install the switch according to standard installation practices making sure to use thread sealant on all of the connections.
2. Attach the Rosemount 702 Transmitter housing to the switch by using the pipe fittings threaded into the conduit entries.

---

#### Note

Direct mount installation should not be employed when using tubing and connectors such as Swagelok® fittings.

---

3. Attach the switch wiring to the terminals as shown in the wiring diagrams beginning on [page 63](#).
4. If commissioning the device, install the Black Power Module.

---

**Figure 7-1. Direct Mount**

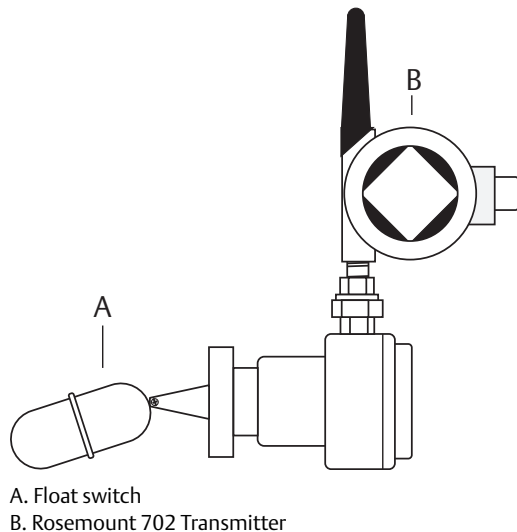

A. Float switch  
B. Rosemount 702 Transmitter

---

#### Note

Use caution when handling the power module, it may be damaged if dropped from heights in excess of 20 ft.

---

---

**Note**

Wireless devices should only be powered up after the Emerson™ Wireless Gateway, in order of proximity from the Gateway beginning with the closest device. This results in a simpler and faster network installation.

---

**Figure 7-2. Power Module Installation**

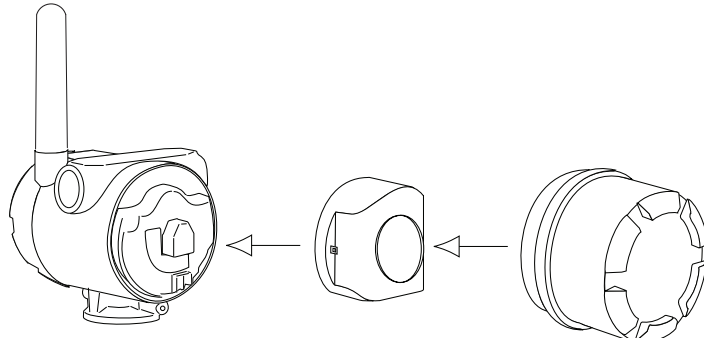

5. Close the housing cover and tighten to safety specifications. Always ensure a proper seal by installing the electronic housing covers so that metal touches metal, but do not overtighten.
6. The antenna should be positioned vertically, typically straight up but the antenna may also be pointed straight down, as shown in [Figure 7-3 on page 61](#).

---

**Figure 7-3. Antenna Positioning**

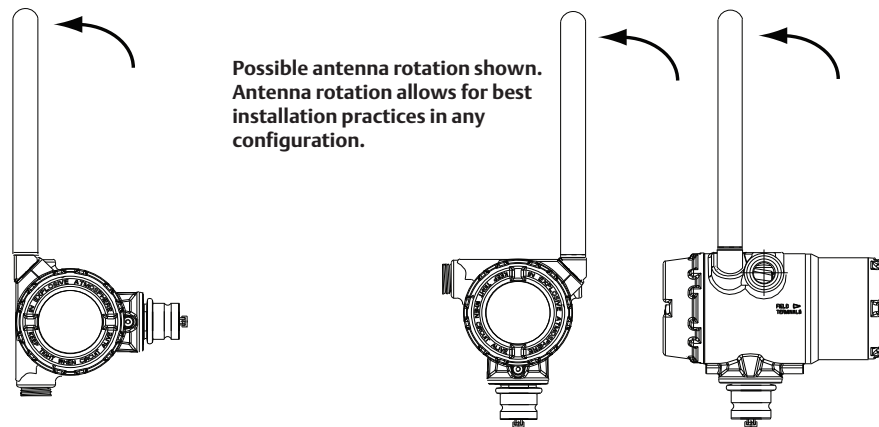

## 7.2.2 Remote mount

1. Install the switch according to standard installation practices being sure to use thread sealant on all of the connections.
2. Run wiring (and conduit, if necessary) from the switch to the Rosemount 702 Transmitter.
3. Pull the wiring through the threaded conduit entry.
4. Attach the switch wiring to the terminals as shown in the wiring diagrams beginning on [page 63](#).
5. If commissioning the transmitter, connect the Black Power Module as shown in [Figure 7-2 on page 61](#).

**Figure 7-4. Remote Mount**

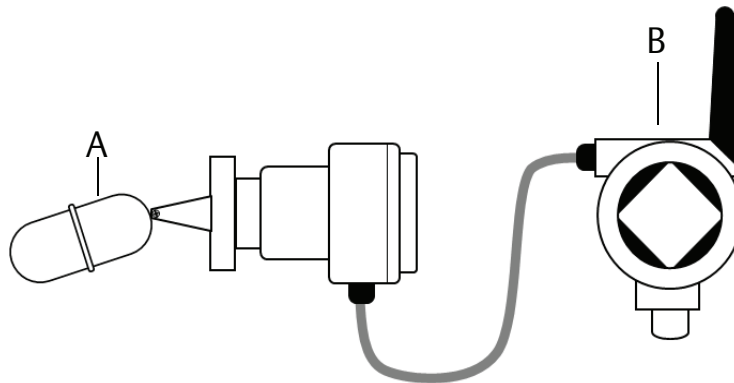

- A. Float switch  
B. Rosemount 702 Transmitter

### Note

Use caution when handling the power module, it may be damaged if dropped from heights in excess of 20 ft.

### Note

Wireless devices should only be powered up after the Gateway, in order of proximity from the Gateway beginning with the closest device. This results in a simpler and faster network installation.

6. Close the housing cover and tighten to safety specifications. Always ensure a proper seal by installing the electronic housing covers so that metal touches metal, but do not overtighten.
7. The antenna should be positioned vertically, typically straight up but the antenna may also be pointed straight down, as shown in [Figure 7-3 on page 61](#).

## 7.3 Wiring switches and sensors

### 7.3.1 Dry contact inputs, measurement option code 32, 42 (702DX32, 702DX42)

#### Terminal block

The Rosemount 702 Transmitter has a pair of screw terminals for each of two channels, and a pair of communication terminals. These terminals are labeled as follows:

- CH1+: Channel 1 Positive
- CMN: Common
- CH2+: Channel 2 Positive
- CMN: Common
- COMM: Communication

Figure 7-5. Terminal Diagram

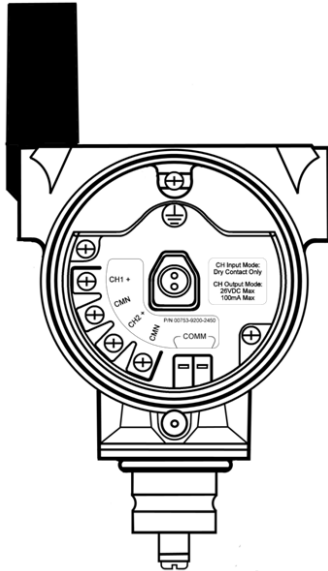

### 7.3.2 Dry contact switch inputs

#### Dual input

The Rosemount 702 Transmitter will accept the input from one or two single pole single throw switches on inputs CH1 and CH2. The wireless output of the transmitter will be both a primary variable (PV) and a secondary variable (SV). The PV is determined by the CH1 input. The SV is determined by the CH2 input. A closed switch drives a TRUE output. An Open switch drives a FALSE output.

#### Note

Any dry contact input can be inverted by the device, so as to change the discrete logic state. This is useful, for instance, if a normally open switch is used to replace a normally closed switch.

Figure 7-6. Single, Dual Input

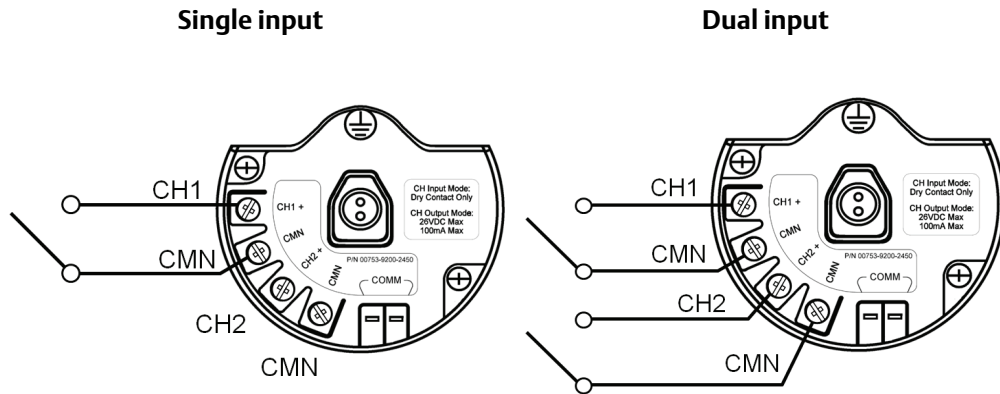

### Dual input, limit contact logic

When configured for limit contact logic, the Rosemount 702 Transmitter will accept the input from two single pole single throw switches on inputs CH1 and CH2, and will use limit contact logic for the determination of the wireless outputs. Reference [Figure 9-3 on page 81](#) for details on the wireless outputs available when using limit contact logic.

Figure 7-7. Dual Input, Limit Contacts

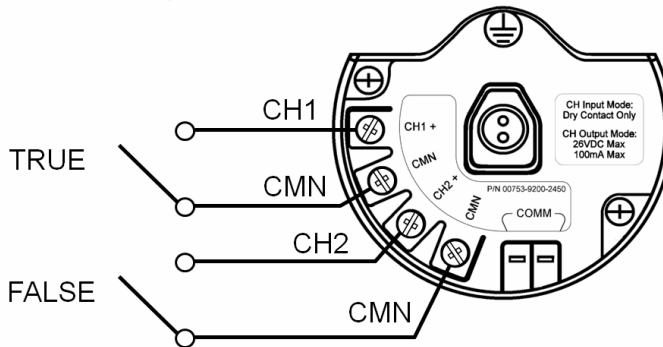

### Dual input, opposing contact logic

When configured for Opposing Contact Logic, the 702 Transmitter will accept the input from a single pole double throw switch on inputs CH1 and CH2, and will use opposing contact logic for the determination of the wireless outputs. Reference [Figure 9-4 on page 82](#) for details on the wireless outputs available when using opposing contact logic.



Figure 7-8. Dual Input, Opposing Contact

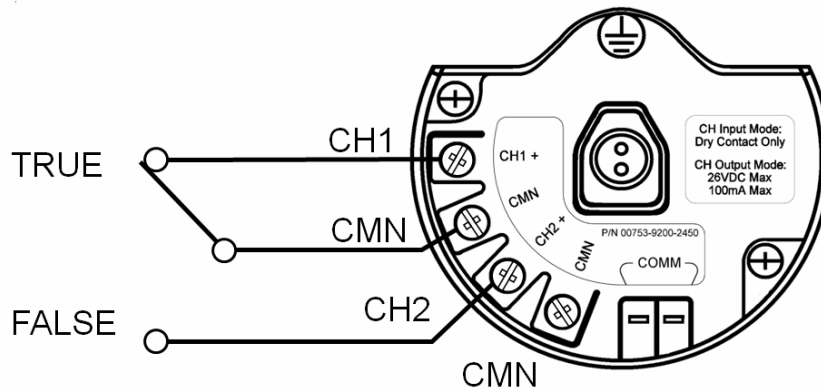

### 7.3.3 Output circuits, measurement option code 42 (702DX42)

The Rosemount 702 Transmitter has two channels that can each be configured for discrete input or output. Inputs must be dry contact switch inputs and these were described in a preceding section of this document. Outputs are a simple switch closure to activate an output circuit. The transmitter output does not provide any voltage or current, the output circuit must have power of its own. The transmitter output has maximum switch capacity per channel of 26 volts DC and 100 milliamps. A typical power supply for powering an output circuit can be 24 volts or lower.

**Note**

It is very important that the polarity of the output circuit is as shown in the wiring diagrams, with the positive (+) side of the circuit wired to the CH1+ or CH2 + terminal, and the negative (-) side of the circuit wired to the CMN terminal. If the output circuit is wired backwards it will remain active (switch closed) regardless of the state of the output channel.

**Note**

The output functionality of the Rosemount 702 Transmitter requires that the network is managed by a version 4 Gateway, with v4.3 firmware installed.

Figure 7-9. Output Circuit Wiring

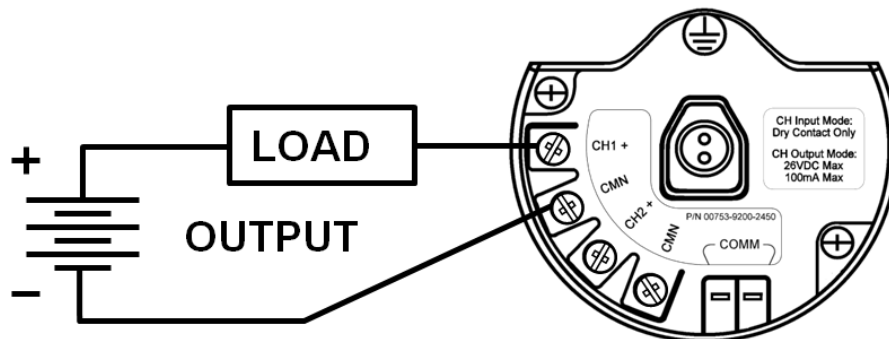
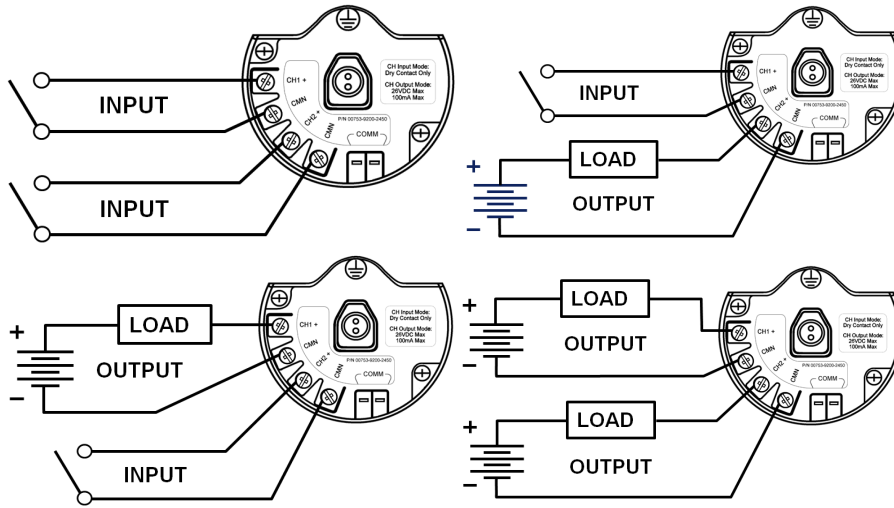

Figure 7-10. Possible Configurations for Both Channel 1 and Channel 2



### Special considerations for dual output circuits

If both channels are connected to output circuits, it is very important that the CMN terminal of each circuit be at the same voltage. Employing a common ground for both output circuits is one way to ensure that both circuits have CMN terminals at the same voltage.

Figure 7-11. Dual Output Circuits with Common Ground

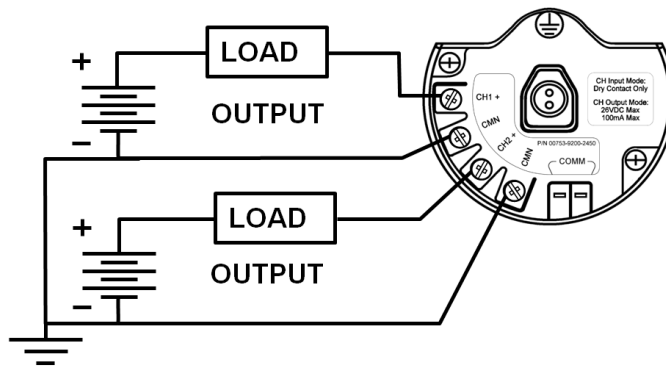

If two output circuits are connected to a single Rosemount 702 Transmitter with a single power supply, both CH + and CMN terminals must be connected to each output circuit. The negative power supply wires must be at the same voltage and connected to both CMN terminals.

Figure 7-12. Dual Output Circuits with One Power Supply

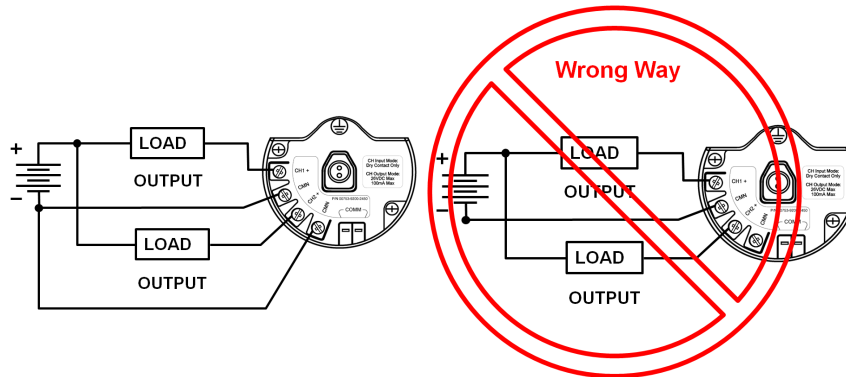

## Switching greater currents or voltages

It is important to note that the maximum output switching capacity is 26 volts DC and 100 milliamps. If a greater voltage or current is to be switched, an interposing relay circuit can be used. Figure 7-13 shows an example of a circuit to switch higher currents or voltages.

Figure 7-13. Wiring an Interposing Relay to Switch Greater Currents or Voltages

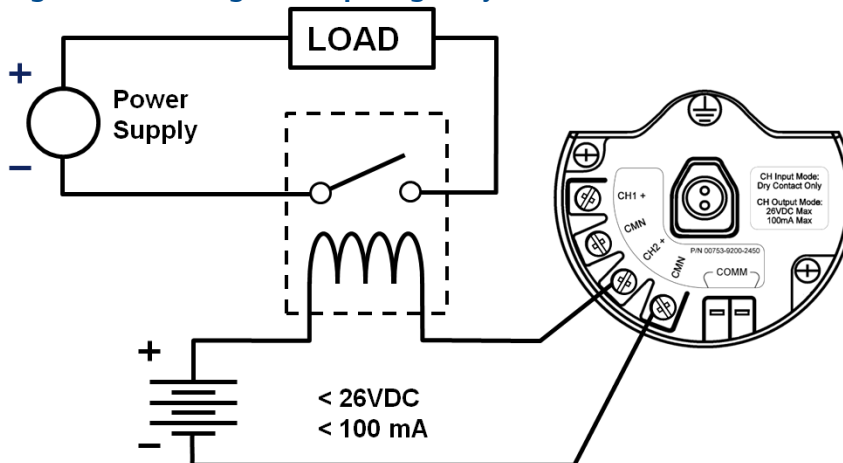

### 7.3.4 Safety shower and eye wash monitoring

The Rosemount 702 Transmitter can be used to monitor safety showers and eye wash stations by using switch kits provided by TopWorx™, an Emerson company. These kits are ordered as a part of the transmitter model code and are available for both insulated and un-insulated pipes. These kits contain the switches, brackets and cables that are necessary to install the transmitter to monitor both the safety shower and the eye wash in a single station. Because each has two input channels, one transmitter can be used to monitor both a safety shower and an eye wash.

Each Safety Shower Monitoring kit contains:

- Two TopWorx Go™ Switch magnetic proximity switches
- Two cables, one six foot and one 12 foot
- Two black polymer cable glands
- Mounting kit for safety shower and eye wash

## Safety shower monitoring

When the shower valve is activated (valve open) by pulling down on the handle, the TopWorx switch is activated (closed switch) and the Rosemount 702 Transmitter senses that switch closure. This switch state is then transmitted by the transmitter to the Gateway, which then sends that information to the control host or alert system. When the shower valve is closed, the switch remains in the activated state until it is reset by a technician. The switch can be re-set only by placing a ferrous metal object on the far side of the sensing area of the switch.

**Figure 7-14. TopWorx Switch Installed on a Safety Shower**



**Figure 7-15. Detail of the Switch Installation on a Safety Shower**

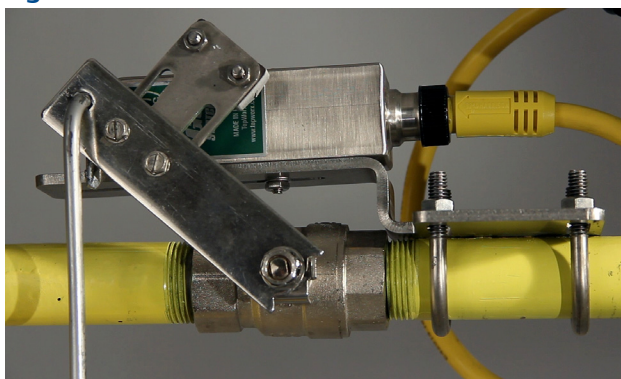
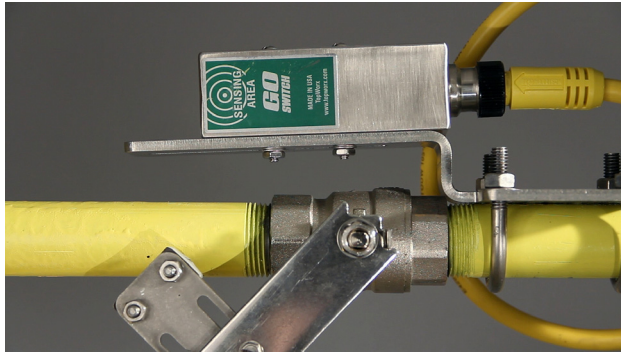

Figure 7-16. Safety Shower Valve in the Activated Position.



## Eye wash monitoring

When the eye wash valve is activated (valve open) by pushing down on the hand paddle, the TopWorx switch is activated (closed switch) and the Rosemount 702 Transmitter senses that switch closure. This switch state is then transmitted by the transmitter to the Gateway, which then sends that information to the control host or alert system. When the eye wash valve is closed, the switch remains in the activated state until it is reset by a technician. The switch can be re-set only by placing a ferrous metal object on the far side of the sensing area of the switch.

Figure 7-17. TopWorx Switch Installed on an Eye Wash Station.



Figure 7-18. Eye Wash in Activated Position



## Installation of safety shower and eye wash monitoring kits

Drawings to aid in the installation of safety shower and eye wash kits can be found in [Appendix D: Safety Shower Monitoring](#) on page 123 of this Reference Manual.

## 7.4 LCD display

if an LCD display is ordered, it will be shipped attached to the transmitter.

The optional LCD display can be rotated in 90-degree increments by squeezing the two tabs, pulling out, rotating and snapping back into place.

If the LCD display pins are inadvertently removed from the interface board, carefully re-insert the pins before snapping the LCD display back into place.

### Installing the optional LCD display

To install the LCD display, use [Figure 7-19 on page 70](#) and the following instructions:

- ⚠ 1. Remove the LCD display cover. Do not remove the instrument cover in explosive environments when the circuit is live.
2. Put the four-pin connector into the LCD display, rotate to the desired position and snap into place.

Note the following LCD display temperature limits:

Operating: -4 to 175 °F (-20 to 80 °C)

Storage: -40 to 185 °F (-40 to 85 °C)

3. Replace the transmitter cover.

#### Note

Only use Rosemount wireless LCD display part number: 00753-9004-0002.

**Figure 7-19. Optional LCD Display**

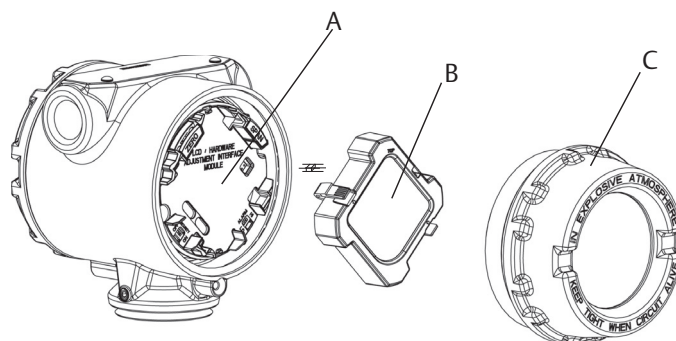

- A. LCD display pins
- B. LCD display display
- C. LCD display cover

## 7.5 Grounding the transmitter

The Rosemount 702 Transmitter operates with the housing grounded or floating. Floating systems, however, can cause extra noise that may affect many types of readout devices. If the signal appears noisy or erratic, grounding at a single point may solve the problem. Grounding of the electronics enclosure should be done in accordance with local and national installation codes. Grounding is accomplished through the process connection using the internal or external case grounding terminal.

### Determining grounding requirements

Each process installation has different grounding requirements. Use the options recommended by the facility for the specific switch type, or begin with Option 1, which is the most common.

#### Option 1

1. Connect switch wiring shield to the grounded transmitter housing.
2. Ensure that the transmitter housing is electrically isolated from the switch wiring.

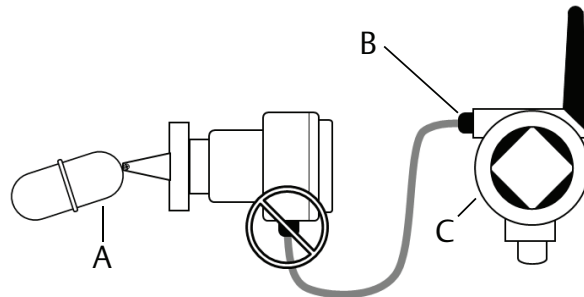

#### Option 2

1. Ground switch wiring shield at the switch.
2. Ensure that the switch wiring and shield are electronically isolated from the transmitter housing.

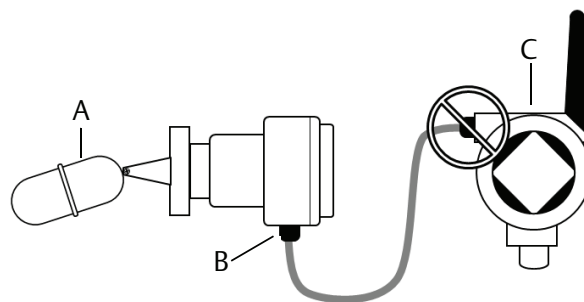

#### Note

Always use facility recommended wiring practices.





---

# Section 8 Commissioning: Models 702DX32 and 702DX42

---

---

Safety messages .....	page 73
Configuring wireless network communication .....	page 74
Field Communicator .....	page 74
Verifying operation .....	page 74

---

## 8.1 Safety messages

Instructions and procedures in this section may require special precautions to ensure the safety of the personnel performing the operations. Information that potentially raises safety issues is indicated by a warning symbol (⚠). Refer to the following safety messages before performing an operation preceded by this symbol.

### **⚠ WARNING**

**Failure to follow these installation guidelines could result in death or serious injury.**

Make sure only qualified personnel perform the installation.

**Explosions could result in death or serious injury.**

- Before connecting a Field Communicator in an explosive atmosphere, make sure the instruments are installed in accordance with intrinsically safe or non-incendive field wiring practices.
- Verify that the operating atmosphere of the transmitter is consistent with the appropriate hazardous locations certifications.

**Process leaks could result in death or serious injury.**

- Do not remove the switch while in operation.
- Install and tighten sensors before applying pressure.

**Electrical shock could cause death or serious injury.**

Use extreme caution when making contact with the leads and terminals.

---

### **Note**

The Rosemount™ 702 Transmitter and all other wireless devices should be installed only after the gateway has been installed and is functioning properly.

Wireless devices should be powered up in order of proximity from the gateway, beginning with the device closest to the Gateway. This will result in a simpler and faster network installation.

---

## 8.2 Configuring wireless network communication

In order to communicate with the Emerson™ Wireless Gateway, and ultimately the information system, the transmitter must be configured to communicate with the wireless network. This step is the wireless equivalent of connecting wires from a transmitter to the information system. Using a Field Communicator or AMS Wireless Configurator, enter the Network ID and Join Key so that they match the Network ID and Join Key of the gateway and other devices in the network. If the Network ID and Join Key are not identical, the Rosemount 702 Transmitter will not communicate with the network. The Network ID and Join Key may be obtained from the Emerson Wireless Gateway on the *Setup>Network>Settings* page on the web server, shown in Figure 8-1.

Figure 8-1. Gateway Network Settings

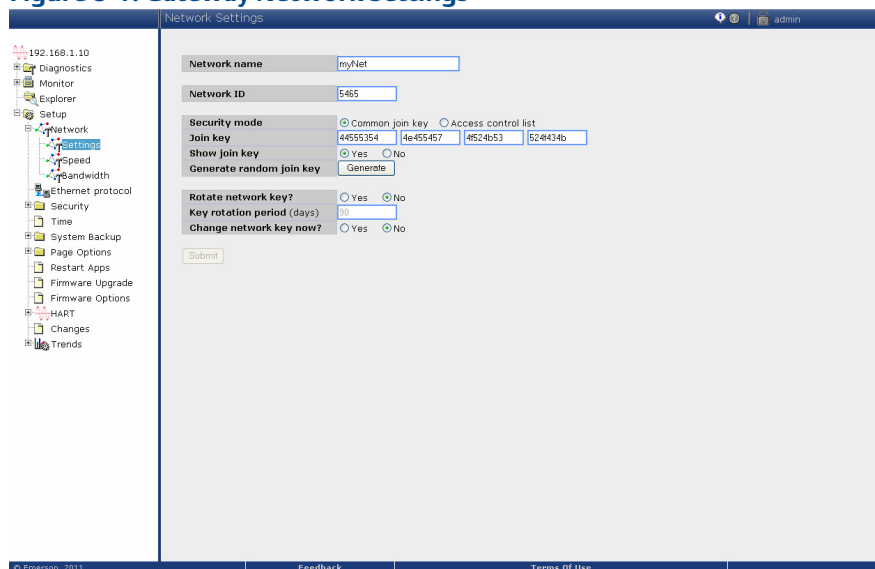

### AMS Wireless Configurator

Right click on the Rosemount 702Transmitter and select Configure. When the menu opens, select Join Device to Network and follow the method to enter the Network ID and Join Key.

### Field Communicator

The Network ID and Join Key may be changed in the wireless device by using the following Fast Key sequence. Set both Network ID and Join Key.

Function	Key sequence	Menu items
Wireless setup	2, 1, 1	Network ID, Set Join Key

## 8.3 Verifying operation

There are four ways to verify operation: using the optional local display (LCD), using the Field Communicator, using the Gateway's integrated web interface, or by using AMS Wireless Configurator. If the Rosemount 702 Transmitter was configured with the Network ID and Join Key, and sufficient time has passed, the transmitter will be connected to the network.

## Troubleshooting

If the device is not joined to the network after power up, verify the correct configuration of the Network ID and Join Key, and verify that Active Advertising has been enabled on the Gateway. The Network ID and Join Key in the device must match the Network ID and Join Key of the Gateway.

## Operating the local LCD display

During steady state operation, the LCD display gives a periodic display of user-chosen variables at the configured wireless update rate. These variables can be chosen from a list of six: Channel 1 State, Channel 1 Count, Channel 2 State, Channel 2 Count, Electronics Temperature, and Supply Voltage. The chevron-shaped status bar at the top of the screen indicates the progress of the network join process. When the status bar is filled, the device is successfully connected to the wireless network.

Start-up Display Sequence: When the Rosemount 702 Transmitter is first powered up, the LCD display will display a sequence of screens: All Segments On, Device Identification, Device Tag, and then the user-chosen variables of the Periodic Display.

## Diagnostic button display sequence

More detailed diagnostic information can be obtained by removing the display cover of the Rosemount 702 Transmitter, and momentarily depressing the "DIAG" button. The LCD will display the diagnostic screens as shown below. Press the **Diagnostic button** to display the TAG, Device ID, Network ID, Network Join Status and Device Status screens.

Figure 8-2. Start-Up Screen Sequence

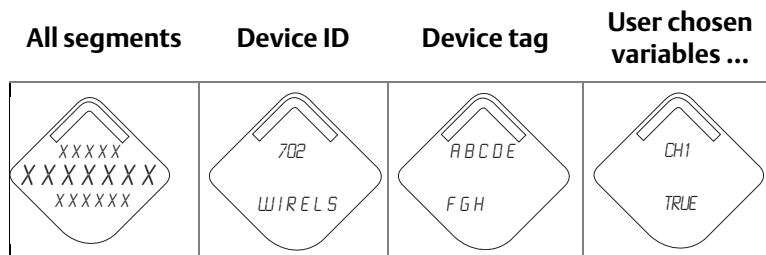

Figure 8-3. Diagnostic Screen Sequence

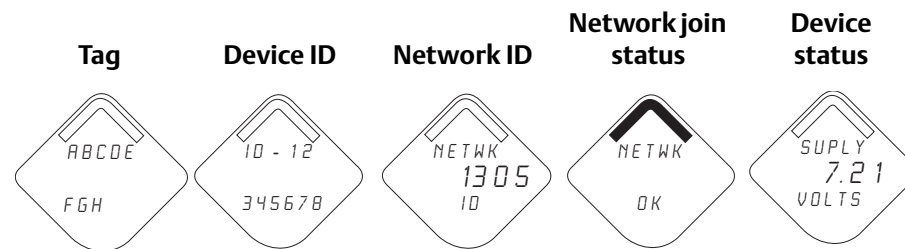
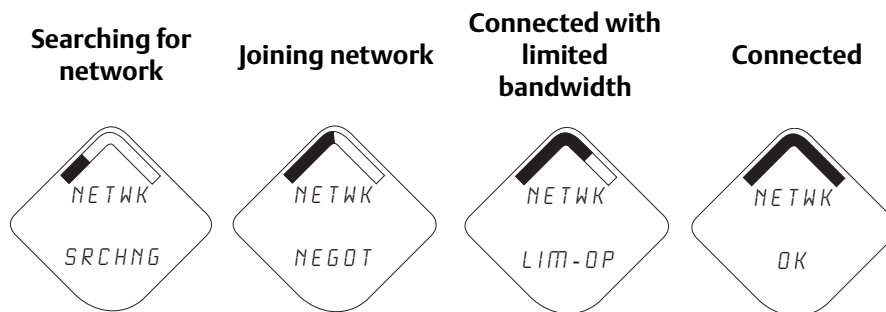

Figure 8-4. Network Join Status Screens



## Field Communicator

A Rosemount 702 DD is required for HART communication. For connecting with a Field Communicator, refer to [Figure 2-3 on page 10](#).

Function	Key sequence	Menu items
Communications	3, 4	Join Status, Communication Status, Join Mode, Number of Available Neighbors, Number of Advertisements Heard, Number of Join Attempts

## Gateway

In the integrated web interface from the Gateway, navigate to the Explorer page. This page shows whether the device has joined the network and if it is communicating properly.

### Note

The time to join the new device(s) to the network is dependent upon the number of devices being joined and the number of devices in the current network. For one device joining an existing network with multiple devices, it may take up to five minutes. It may take up to 60 minutes for multiple new devices to join the existing network.

## Alarm configuration

If the device joins the network and immediately has an alarm present, it is likely due to sensor configuration. Check the sensor wiring (see [“Terminal Block” on page 9](#)) and the sensor configuration (see [“Fast Key sequence” on page 13](#)).

Figure 8-5. Emerson Wireless Gateway Explorer Page

HART Tag	HART status	Last update	PV	SV	TV	QV	Burst rate
2160_Level	●	04/20/11 18:09:53	0.000	1394.483 Hz	23.000 DegC	7.502 V	8
30515_Pressure	●	04/20/11 18:09:55	-0.027 InH2O 68F	22.750 DegC	22.750 DegC	7.115 V	8
6081_Conductivity	●	04/20/11 18:09:42	9.795 pH	23.322 DegC		7.283 V	16
6081_pH	●	04/20/11 18:09:50	9.803 pH	22.822 DegC	-165.002 mV	7.287 V	16
648_Temperature	●	04/20/11 18:09:55	22.859 DegC	NaN DegC	22.500 DegC	7.116 V	8
4320_Position	●	04/20/11 18:09:57	1.000 %	1.000	0.000	23.000 DegC	4
702_Discrete	●	04/20/11 18:09:53	1.000	0.000	23.250 DegC	7.063 V	8
848_Temperature	●	04/20/11 18:09:55	22.850 DegC	22.822 DegC	22.822 DegC	24.861 DegC	32
9420_Vibration	●	04/20/11 17:25:22	0.023 in/s	0.022 g's	2.501 V	7.143 V	01:00:00
248_Temperature	●	04/20/11 18:09:55	22.959 DegC	NaN DegC	22.550 DegC	7.116 V	16
708_Acoustic	●	04/20/11 18:09:54	6.378 Counts	24.559 DegC	22.550 DegC	3.391 V	16

### 8.3.1 AMS Wireless Configurator

When the device has joined the network, it will appear in the Device Manager as illustrated below:

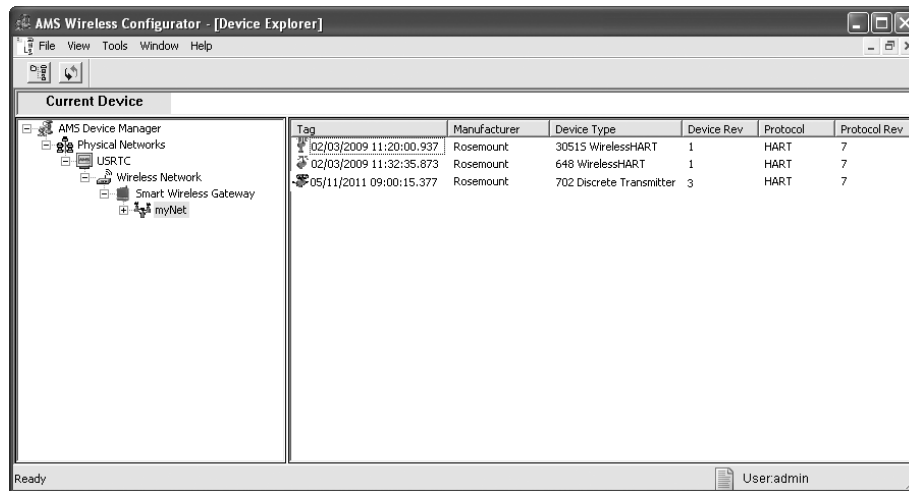

### Troubleshooting

If the device is not joined to the network after power up, verify the correct configuration of the Network ID and Join Key, and verify that Active Advertising has been enabled on the Gateway. The Network ID and Join Key in the device must match the Network ID and Join Key of the Gateway.

## Changing the network ID and join key

The Network ID and Join Key may be obtained from the Gateway on the *Setup>Network>Settings* page on the web interface (see [Figure 8-5 on page 77](#)). The Network ID and Join Key may be changed in the wireless device by using the following Fast Key sequence.

Function	Key Sequence	Menu Items
Wireless	2,1,1	Join Device to Network

---

# Section 9      Operation and Maintenance: Models 702DX32 and 702DX42

---

Safety messages .....	page 79
Discrete input from switches .....	page 80
Discrete output circuits .....	page 86
Interpreting the LCD display screen messages .....	page 90
Replacing the power module .....	page 97

---

## 9.1      Safety messages

Instructions and procedures in this section may require special precautions to ensure the safety of the personnel performing the operations. Information that potentially raises safety issues is indicated by a warning symbol (⚠). Refer to the following safety messages before performing an operation preceded by this symbol.

### **⚠ WARNING**

**Failure to follow these installation guidelines could result in death or serious injury.**

Make sure only qualified personnel perform the installation.

**Explosions could result in death or serious injury.**

- Before connecting a Field Communicator in an explosive atmosphere, make sure the instruments are installed in accordance with intrinsically safe or non-incendive field wiring practices.
- Verify that the operating atmosphere of the transmitter is consistent with the appropriate hazardous locations certifications.

**Process leaks could result in death or serious injury.**

- Do not remove the switch while in operation.
- Install and tighten sensors before applying pressure.

**Electrical shock could cause death or serious injury.**

Use extreme caution when making contact with the leads and terminals.

---

## 9.2 Discrete input from switches

### 9.2.1 Dry contact inputs, measurement option code 32, 42 (702DX32, 702DX42)

The Rosemount 702 Transmitter has a pair of screw terminals for each of two channels, and a pair of communication terminals. These terminals are labeled as follows:

- CH1+: Channel 1 Positive
- CMN: Common
- CH2+: Channel 2 Positive
- CMN: Common
- COMM: Communication

Figure 9-1. Terminal Diagram

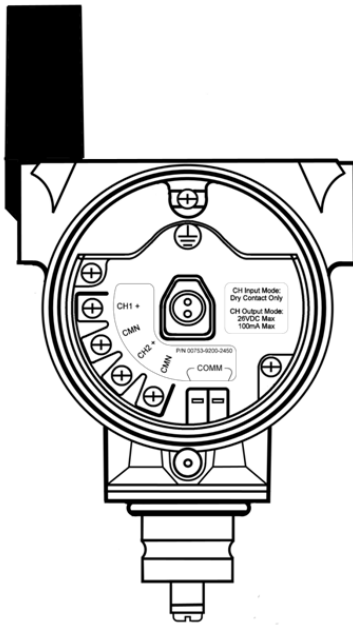

### 9.2.2 Wireless output specifications

#### Dual Input

The Rosemount 702 Transmitter will accept the input from one or two single pole single throw switches on inputs CH1 and CH2. The wireless output of the transmitter will be both a primary variable (PV) and a secondary variable (SV). The PV is determined by the CH1 input. The SV is determined by the CH2 input. A closed switch drives a TRUE output. An Open switch drives a FALSE output.

#### Note

Any dry contact input can be inverted by the device, so as give the opposite effect. This is useful, for instance, if a normally open switch is used to replace a normally closed switch.



Figure 9-2. Single and Dual Input

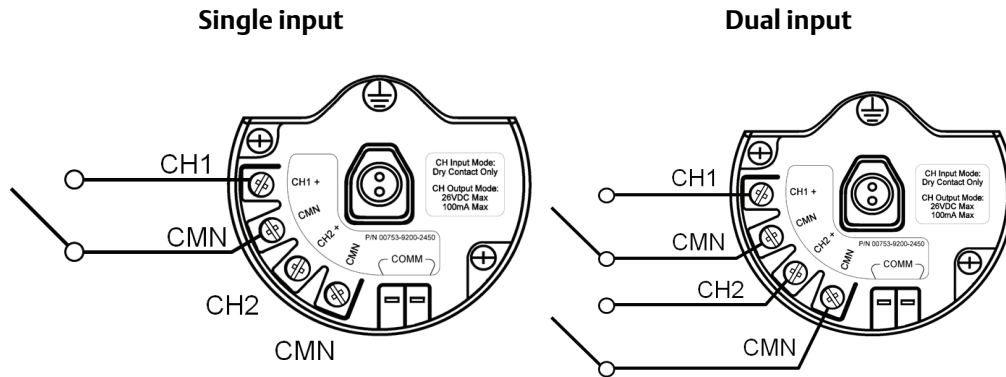

Switch Input	Wireless output	Switch input	Wireless output
CH1	PV	CH2	SV
Closed	TRUE (1.0)	Closed	TRUE (1.0)
Open	FALSE (0.0)	Open	FALSE (0.0)

### Dual input, limit contact logic

When configured for limit contact logic, the Rosemount 702 Transmitter will accept the input from two single pole single throw switches on inputs CH1 and CH2, and will use limit contact logic for the determination of the wireless outputs. The following tables describe the wireless outputs available when using limit contact logic.

Figure 9-3. Dual Input, Limit Contacts

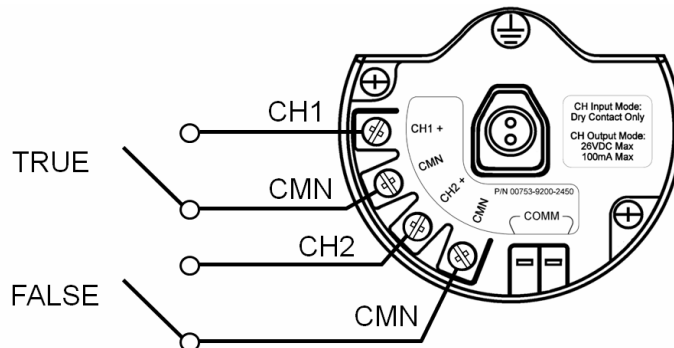

Switch inputs		Wireless outputs	
CH1	CH2	PV	SV
Open	Open	TRAVEL (0.5)	TRAVEL (0.5)
Open	Closed	FALSE (0.0)	FALSE (0.0)
Closed	Open	TRUE (1.0)	TRUE (1.0)
Closed	Closed	FAULT(NaN)	FAULT(NaN)

### Dual Input, opposing contact logic

When configured for Opposing Contact Logic, the 702 Transmitter will accept the input from a single pole double throw switch on inputs CH1 and CH2, and will use opposing contact logic for the determination of the wireless outputs. The following tables describe the wireless outputs available when using opposing contact logic.

Figure 9-4. Dual Input, Opposing Contact

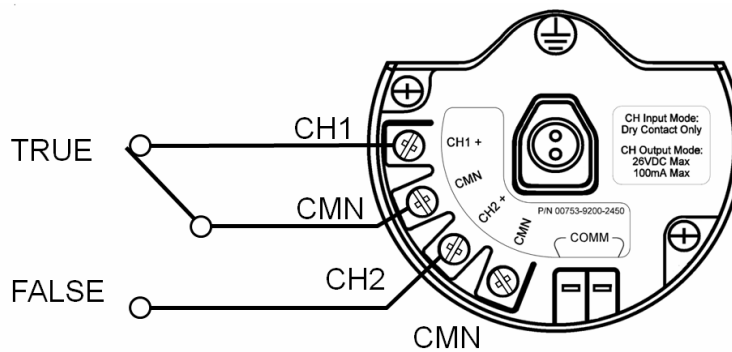

Switch inputs		Wireless outputs	
CH1	CH2	PV	SV
Open	Open	FAULT(NaN)	FAULT(NaN)
Open	Closed	FALSE (0.0)	FALSE (0.0)
Closed	Open	TRUE (1.0)	TRUE (1.0)
Closed	Closed	FAULT(NaN)	FAULT(NaN)

### 9.2.3 Momentary discrete inputs, measurement option code 32 and 42 (702DX32, 702DX42)

The Rosemount 702 Transmitter is capable of measuring momentary discrete inputs of 10 millisecond or more in duration, regardless of the wireless update rate. At each wireless update, the device reports current discrete input state and an accumulating count of close-open cycles for each input channel.

Figure 9-5. Momentary Inputs and Accumulating Count

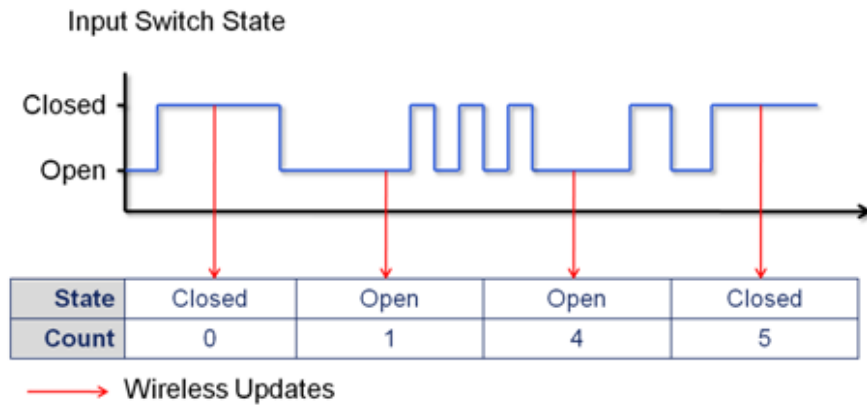
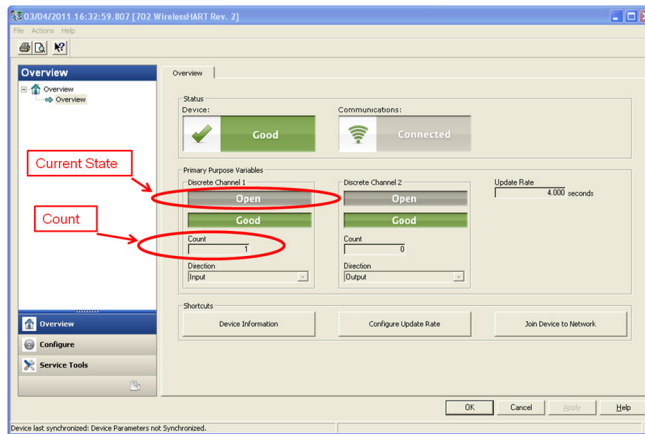

Figure 9-6. Reporting of Current Discrete State and Count in AMS Wireless Configurator



## Setting variable reporting in AMS Wireless Configurator

The Rosemount 702 Transmitter has two choices for variable reporting: Classic - Discrete State Only, or Enhanced – Discrete State and Count. In the Classic variable reporting mode, the transmitter will report variables exactly like the previous version of the device (measurement option code 22). In the Enhanced variable reporting mode, the transmitter will provide both current state of the discrete channels, and a count of the discrete state change cycles. Following is a table that shows the variable mapping for both cases. Variable Reporting can be set in AMS Wireless Configurator by going to *Configure > Manual Setup > HART*.

Table 9-1. Variable Mapping

Variable reporting	PV	SV	TV	QV
Classic – discrete state only	CH1 State	CH2 State	Electronics temperature	Supply voltage
Enhanced – discrete state with count	CH1 State	CH2 State	CH1 Count	CH2 Count

## Setting the reported value in AMS Wireless Configurator

The Rosemount 702 Transmitter reports the discrete state of switches wired to the input channels. There are various pairs of discrete states that correspond to an open or closed input switch. This pair of discrete states is called the Reported Value and can be set in AMS Wireless Configurator by going to *Configure > Manual Setup > Discrete Channels > Setup Channel X (1 or 2)*. Under Reported Value there is a drop down menu of choices. The Reported Value can be set independently for each of the two channels.

Figure 9-7. Setting the Reported Value

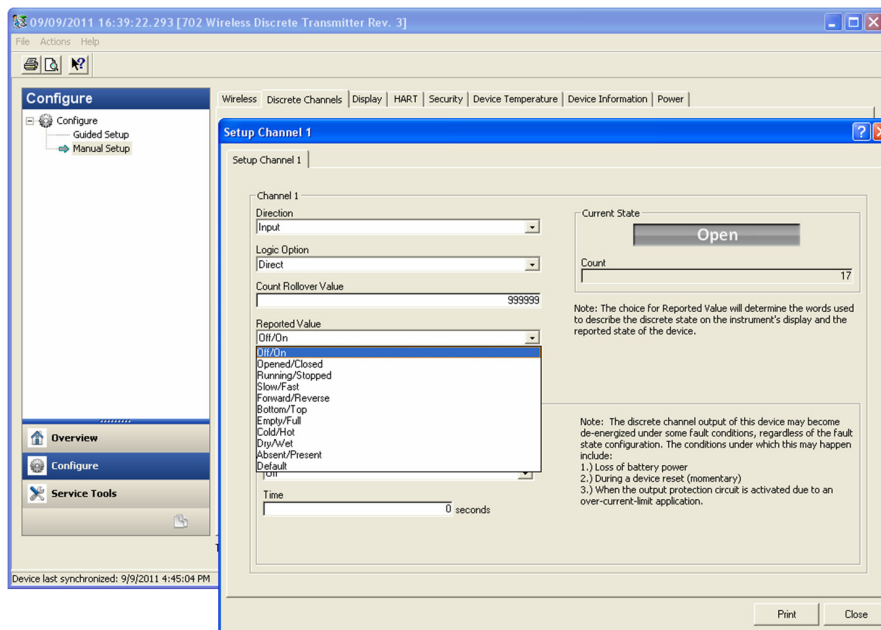

**Reported Value:** Table 9-2 gives the reported value choices and the names for each possible state. Also given are the corresponding analog value and discrete value for each possible state.

**Value Name:** The Name of the reported value will be seen in AMS Wireless Configurator, and on the device display. The device display may shorten the name to fit the available display segments.

**Analog Value:** The analog value is seen on the gateway web interface under the PV or SV. This is also the value that is reported through the gateway to a control host that requires an analog floating point value for PV or SV.

**Discrete Value:** The discrete value is reported through the gateway to a control host that requires the true discrete state value, rather than the floating point decimal of the Analog Value.

**Table 9-2. State Table for Reported Values**

Dual independent, or single channel application types						
Reported value	Value name		Analog Value		Discrete Value	
	Open switch	Closed switch	Open switch	Closed switch	Open switch	Closed switch
Default	False	True	0.000	1.000	240	242
Off/On	Off	On	0.000	1.000	0	1
Opened/Closed	Opened	Closed	46.000	6.000	46	6
Running/Stopped	Stopped	Running	25.000	26.000	25	26
Slow/Fast	Slow	Fast	8.000	7.000	8	7
Forward/Reverse	Forward	Reverse	9.000	10.000	9	10
Bottom/Top	Bottom	Top	12.000	11.000	12	11
Empty/Full	Empty	Full	14.000	13.000	14	13
Cold/Hot	Cold	Hot	16.000	15.000	16	15
Dry/Wet	Dry	Wet	32.000	33.000	32	33
Absent/Present	Absent	Present	45.000	44.000	45	44

**Note**

Changing logic option from direct to inverted has the effect of changing “Open Switch” to “Closed Switch” on the table above.

**Variable reporting, limit contact or opposing contact logic**

If the Rosemount 702 Transmitter has two inputs and is set for limit contact or opposing contact logic, there is a different list of reported values. [Table 9-3](#) describes the values that are reported as a function of the Reported Value setting, and the four possible discrete states of True, False, Fault and Travel. Reference [Figure 9-3 on page 81](#) for limit contact switches and [Figure 9-4 on page 82](#) for opposing contact switches.

**Table 9-3. Limit Contact and Opposing Contact**

Dual input limit contact logic, or dual input opposing contact logic application types												
Reported value	Value name				Analog value				Discrete value			
	False switch active	True switch active	Fault	Travel	False switch active	True switch active	Fault	Travel	False switch active	True switch active	Fault	Travel
Default	False	True	Fault	Travel	0.000	1.000	NAN	0.500	240	242	243	241
All Others	False	True	Fault	Travel	0.000	1.000	243.0	241.0	240	242	243	241

## 9.3 Discrete output circuits

### Output circuits, measurement option code 42

The Rosemount 702 Transmitter has two channels that can each be configured for discrete input or output. Inputs must be dry contact switch inputs and these were described in a preceding section of this document. Outputs are a simple switch closure to activate an output circuit. Transmitter output does not provide any voltage or current, the output circuit must have power of its own. Transmitter output has maximum switch capacity per channel of 26 volts DC and 100 milliamps. A typical power supply for powering an output circuit can be 24 volts or lower.

#### Note

It is very important that the polarity of the output circuit is as shown in the wiring diagrams, with the positive (+) side of the circuit wired to the CH2 + terminal, and the negative (-) side of the circuit wired to the CMN terminal. If the output circuit is wired backwards it will remain active (switch closed) regardless of the state of the output channel.

### Discrete output switch functionality

The discrete output of the Rosemount 702 Transmitter is driven by the host control system, through the Emerson Wireless Gateway, and out to the transmitter. The time required for this wireless communication from the gateway to the transmitter is dependent on many factors, including the size and topology of the network and the total amount of downstream traffic on the wireless network. For a network that is constructed to our best practices, typical delays in communication of a discrete output from the Gateway to the transmitter are 15 seconds or less. Remember that this delay is only part of the latency that will be observed in a control loop.

#### Note

The output functionality of the Rosemount 702 Transmitter requires that the network is managed by a version 4 Emerson Wireless Gateway, with v4.3 firmware installed.

Figure 9-8. Output Circuit Wiring

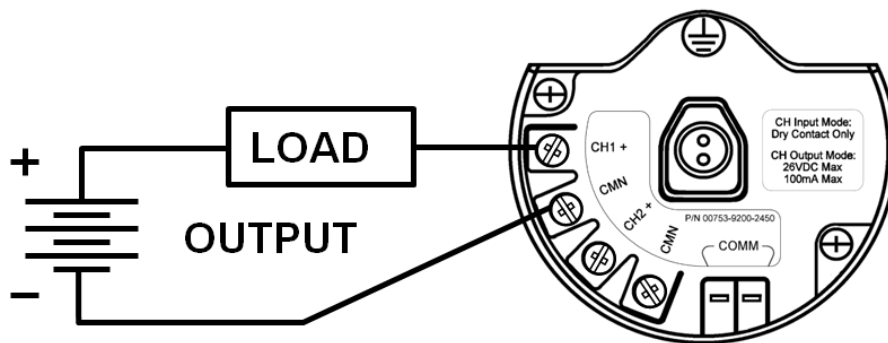

**Figure 9-9. Possible Configurations for Both Channel 1 and Channel 2**

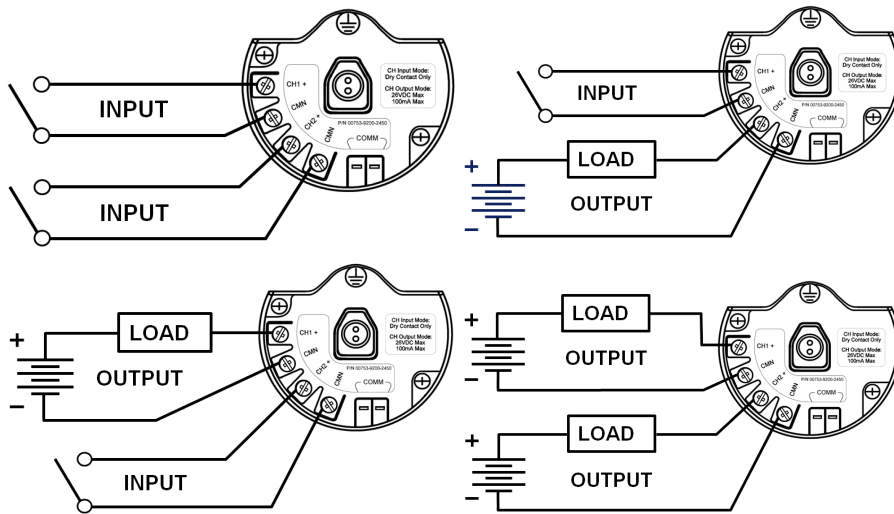

### Discrete output switch voltage and current limits

It is important to note that the maximum output switching capacity is 26 volts DC and 100 milliamps. If a greater is to be switched an interposing relay circuit can be used. [Figure 9-9](#) shows an example of a circuit to switch higher currents or voltages.

### Special considerations for dual output circuits:

If both channels are connected to output circuits, it is very important that the CMN terminal of each circuit be at the same voltage. Employing a common ground for both output circuits is one way to ensure that both circuits have CMN terminals at the same voltage.

**Figure 9-10. Dual Output Circuits with a Common Ground**

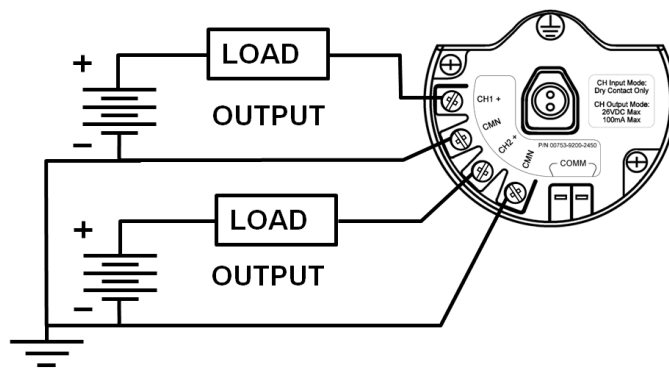

### Connecting two output circuits with a single power supply

If two output circuits are connected to a single Rosemount 702 Transmitter with a single power supply, both CH + and CMN terminals must be connected to each output circuit. The negative power supply wires must be at the same voltage and connected to both CMN terminals.

Figure 9-11. Dual Output Circuits with One Power Supply

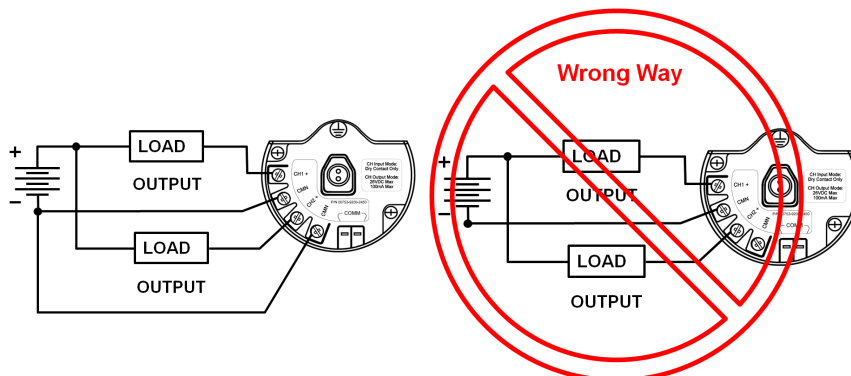

## Switching greater currents or voltages

It is important to note that the maximum output switching capacity is 26 volts DC and 100 milliamps. If a greater voltage or current is to be switched, an interposing relay circuit can be used. Figure 9-12 shows an example of a circuit to switch higher currents or voltages.

Figure 9-12. Wiring an Interposing Relay to Switch Greater Currents or Voltages

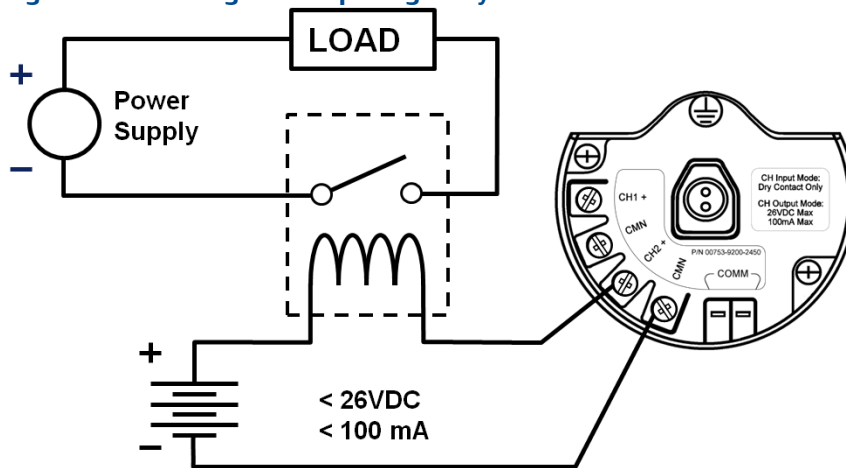

## Setting the reported value

Though the output switch state is driven by command from the control host, the Rosemount 702 Transmitter then reports back the state of the output switch via the PV and SV. There are various pairs of discrete states that correspond to an open or closed output switch. This pair of discrete states is called the reported value and can be set in AMS Device Manager by going to *Configure > Manual Setup > Discrete Channels > Setup Channel X* (1 or 2), under reported value there is a drop down menu of choices. The reported value can be set independently for each of the two channels.

**Reported Value:** Table 9-4 gives the reported value choices and the names for each possible state of the output switch. Also given are the corresponding analog value and discrete value for each possible state.

**Value Name:** The name of the reported value will be seen in AMS Device Manager, and on the device display. The device display may shorten the Name to fit the available display segments.



Analog Value: The analog value is seen on the gateway web interface under the PV or SV. This is also the value that is reported through the gateway to a control host that requires an analog floating point value for PV or SV.

Discrete Value: The discrete value is reported through the gateway to a control host that requires the true discrete state value, rather than the floating point decimal of the analog value.

**Table 9-4. Discrete Output**

Reported value	Value name		Analog value		Discrete value	
	Open switch	Closed switch	Open switch	Closed switch	Open switch	Closed switch
Default	False	True	0.000	1.000	240	242
Off/On	Off	On	0.000	1.000	0	1
Opened/Closed	Opened	Closed	46.000	6.000	46	6
Running/Stopped	Stopped	Running	25.000	26.000	25	26
Slow/Fast	Slow	Fast	8.000	7.000	8	7
Forward/Reverse	Forward	Reverse	9.000	10.000	9	10
Bottom/Top	Bottom	Top	12.000	11.000	12	11
Empty/Full	Empty	Full	14.000	13.000	14	13
Cold/Hot	Cold	Hot	16.000	15.000	16	15
Dry/Wet	Dry	Wet	32.000	33.000	32	33
Absent/Present	Absent	Present	45.000	44.000	45	44
Fault	Fault		243.000		243	

**Note**

The Fault condition applies to all reported value settings.

Changing logic option from direct to Inverted has the effect of changing “Open Switch” to “Closed Switch” on the table above.

The manual override of an output channel changes the value from the “Open Switch” state to the “Closed Switch” state.

## 9.4 Modbus and OPC mapping

Following is a table of parameters that can be used for Modbus and OPC mapping. These parameters are used by the Emerson Wireless Gateway and can be found in the web interface of the gateway. Some of these parameters are analog values and some are discrete, and this is noted in the description. The setpoint parameters are used to drive the output channel and for the readback of the state of the output channel.

Parameter Name	Description	Read/Write
CHANNEL_1_STATE	Analog value for channel 1 state	Read
CHANNEL_1_COUNTS	Analog value for channel 1 state	Read
CHANNEL_1_STATE_D	Discrete value for channel 1 state	Read
CHANNEL_1_SETPOINT_D	Discrete value for channel 1 setpoint	Read/Write
CHANNEL_2_STATE	Analog value for channel 2 state	Read
CHANNEL_2_COUNTS	Analog value for channel 2 state	Read
CHANNEL_2_STATE_D	Discrete value for channel 2 state	Read
CHANNEL_2_SETPOINT_D	Discrete value for channel 2 setpoint	Read/Write
SUPPLY_VOLTAGE	Analog value for power module voltage	Read
DEVICE_TEMPERATURE	Analog value for device temperature	Read

## 9.5 Interpreting the LCD display screen messages

### 9.5.1 Startup screen sequence

The following screens will display when the power module is first connected to the Rosemount 702 Transmitter.

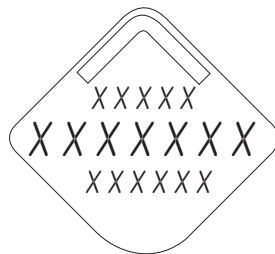

1. All Segments On: used to visually determine if there are any bad segments on the LCD display

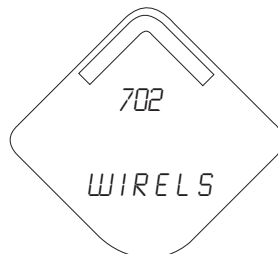

2. Device Identification: used to determine Device Type.

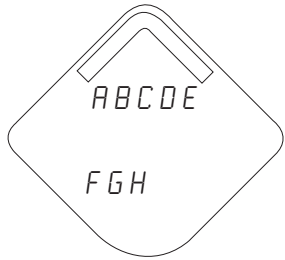

3. Device Information - Tag: user entered tag which is 8 characters long - will not display if all characters are blank

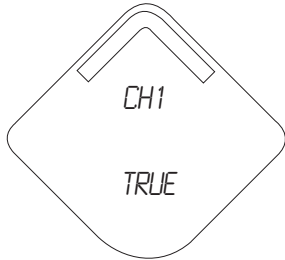

4. PV Screen - Discrete State of Channel 1

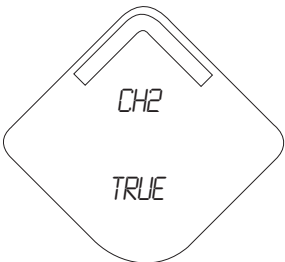

5. SV Screen - Discrete State of Channel 2



6. Electronics Temperature

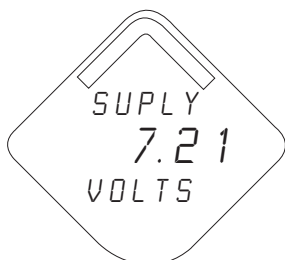

7. Supply Voltage

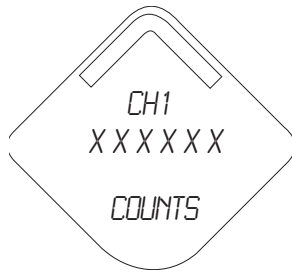

8. Channel 1 Count of close/open cycles

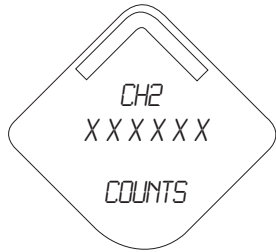

9. Channel 2 Count of close/open cycles

## 9.5.2 Diagnostic button screen sequence

The following five screens will display when the device is operating properly and the Diagnostic Button has been pressed.

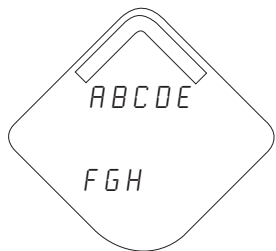

1. Diagnostic Button Screen 1: Tag - user entered tag which is eight characters long - will not display if all characters are blank

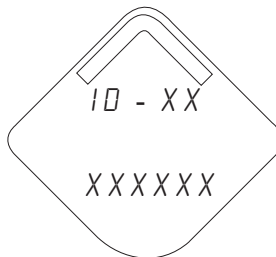

2. Diagnostic Button Screen 2: Device Identification - used to determine Device ID

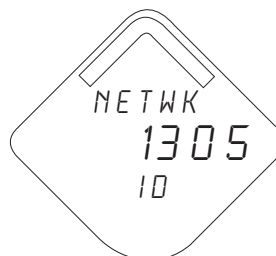

3. Diagnostic Button Screen 3: Network ID



4. Diagnostic Button Screen 4.9: the device has joined a network and has been fully configured and has multiple parents

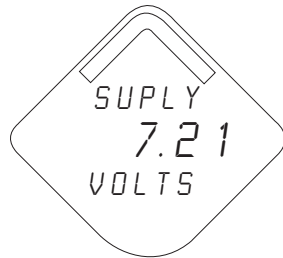

5. Diagnostic Button Screen 5: voltage reading at the power module terminals

### 9.5.3 Network connection status screens

One of the following network diagnostic status screens will display in the fourth position of the Diagnostic Button Screen sequence. The screen displayed is dependent on the progress of the device in joining the wireless network.

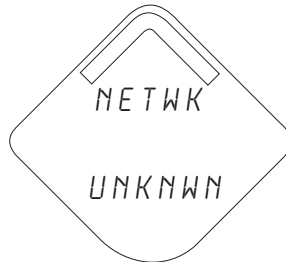

1. Diagnostic Button Screen 4.1: the device is attempting to start the radio

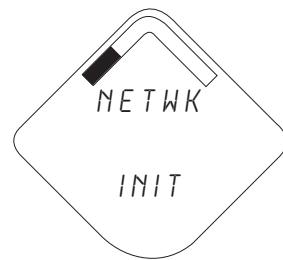

2. Diagnostic Button Screen 4.2: the device has just restarted

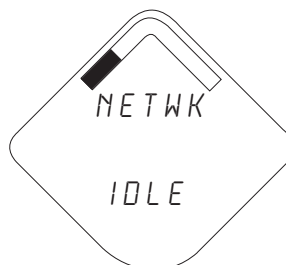

3. Diagnostic Button Screen 4.3: the device is starting to join the process

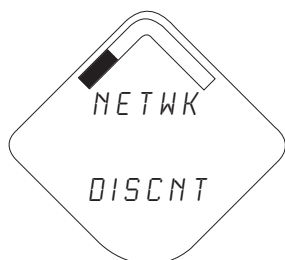

4. Diagnostic Button Screen 4.4: the device is in a disconnected state and requires a “Force Join” command to join the network

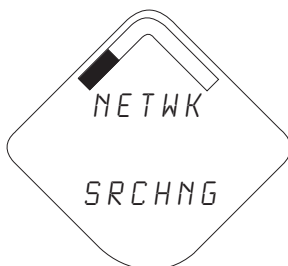

5. Diagnostic Button Screen 4.5: the device is searching for the Network

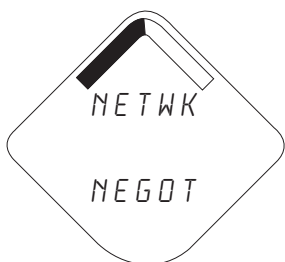

6. Diagnostic Button Screen 4.6: the device is attempting to join a network

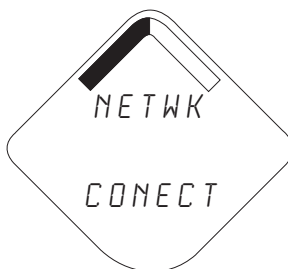

7. Diagnostic Button Screen 4.7: the device is connected to the Network, but is in a “Quarantined” state

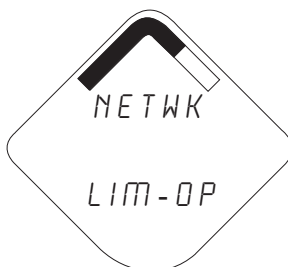

8. Diagnostic Button Screen 4.8: the device is joined and operational, but is running with limited bandwidth for sending periodic data



9. Diagnostic Button Screen 4.9: the device has joined a network and has been fully configured and has multiple parents

## 9.5.4 Device diagnostic screens

The following screens will show the device diagnostics depending on the state of the device, continuing after Diagnostic Button Screen 5.

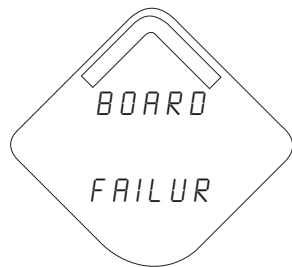

1. Diagnostic Button Screen 6.1: There is a critical error which may prevent the electronics board from operating correctly.

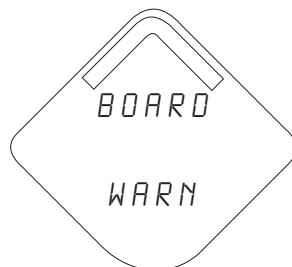

2. Diagnostic Button Screen 6.2: There is a warning which should be addressed, but should not affect the device output.

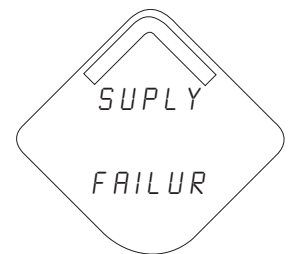

3. Diagnostic Button Screen 7.1: the terminal voltage has dropped below level of operating limit. Replace the Black Power Module model number 701PBKKF (Part Number: 00753-9220-0001).

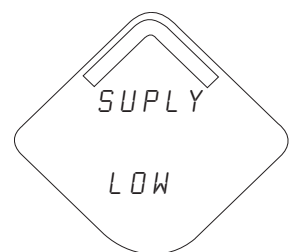

4. Diagnostic Button Screen 7.2: the terminal voltage is below the recommended operating range - if this is a self-operated device, the power module should be replaced. - for line powered devices, the supply voltage should be increased

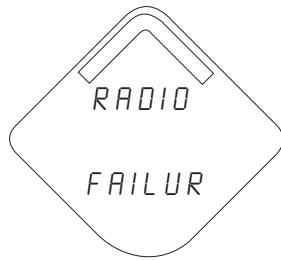

5. Diagnostic Button Screen 8: the device cannot retrieve information from the radio in the device - the device may still be operational and publishing HART data

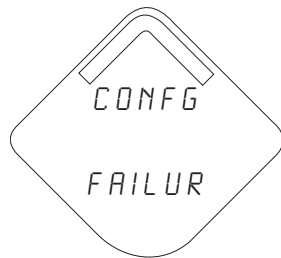

6. Diagnostic Button Screen 9: configuration of the transmitter is invalid such that critical operation of the device may be affected - check the extended configuration status to identify which configuration item(s) need to be corrected

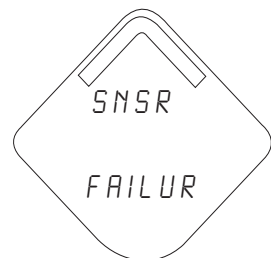

7. Diagnostic Button Screen 10: a switch attached to the transmitter has failed, and valid readings from that switch are no longer possible - check the switch and switch wiring connections - check additional status for more detailed information of the failure source

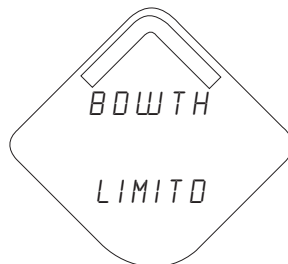

8. Diagnostic Button Screen 11: The device has not yet received all of the requested wireless bandwidth needed to operate as configured.

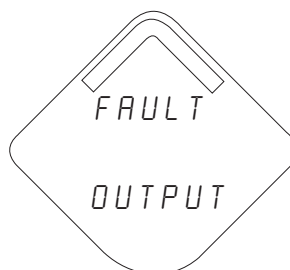

9. Diagnostic Button Screen 12: One or more output channels are being driven to a fault state.



Diagnostic Button Screens 13 +: All of the periodic screens except supply voltage will now be displayed to conclude the Diagnostic Button Screen Sequence. These screens are:

Channel 1 State  
Channel 2 State  
Electronics Temperature  
Channel 1 Count  
Channel 2 Count

---

**Note**

Use Rosemount Wireless LCD Part Number: 00753-9004-0002.

---

## 9.6 Replacing the power module

Expected power module life is 10 years at reference conditions.<sup>(1)</sup>

When the power module needs to be replaced, remove the power module cover and the depleted power module. Replace the power module with a new Black Power Module, SmartPower™ Solutions model number 701PBKKF (part number 00753-9220-0001). Then replace the cover and tighten it specification. Always ensure a proper seal so that metal touches metal, but do not overtighten.

### Handling the power module

The Black Power Module with the wireless unit contains two “C” size primary lithium/thionyl chloride batteries. Each battery contains approximately 2.5 grams of lithium, for a total of 5 grams in each pack. Under normal conditions, the battery materials are self-contained and are not reactive as long as the batteries and the battery pack integrity are maintained. Care should be taken to prevent thermal, electrical or mechanical damage. Contacts should be protected to prevent premature discharge.

Use caution when handling the power module. It may be damaged if dropped from heights in excess of 20 feet.

 Battery hazards remain when cells are discharged.

### Environmental considerations

As with any battery, local environmental rules and regulations should be consulted for proper management of spent batteries. If no specific requirements exist, recycling through a qualified recycler is encouraged. Consult the materials safety data sheet for battery specific information.

### Shipping considerations

The unit was shipped to you without the power module installed. Remove the power module prior to shipping.

Each Black Power Module contains two “C” size primary lithium batteries. Primary lithium batteries are regulated in transportation by the U.S. Department of Transportation, and are also covered by International Air Transport Association (IATA), International Civil Aviation Organization (ICAO), and European Ground Transportation of Dangerous Goods (ARD). It is the responsibility of the shipper to ensure compliance with these or any other local requirements. Consult current regulations and requirements before shipping.

1. Reference conditions are 70 °F (21 °C), wireless update of once per minute, and routing data for three additional network devices.

## 9.7 Service support

To expedite the return process outside of North America, contact your Emerson™ representative,

Within the United States, call the Emerson Response Center toll-free number 1 800 654 7768. The center, which is available 24 hours a day, will assist you with any needed information or materials.

The center will ask for product model and serial numbers, and will provide a Return Material Authorization (RMA) number. The center will also ask for the process material to which the product was last exposed.

### CAUTION

Individuals who handle products exposed to a hazardous substance can avoid injury if they are informed of, and understand, the hazard. If the product being returned was exposed to a hazardous substance as defined by OSHA, a copy of the required Material Safety Data Sheet (MSDS) for each hazardous substance identified must be included with the returned goods.

---

# Appendix A      Reference Data

---

---

Product Certifications .....	page 99
Ordering Information, Specifications, and Drawings .....	page 99

---

## A.1 Product Certifications

To view current Rosemount 702 Product Certifications, follow these steps:

1. Go to [Emerson.com/Rosemount/Rosemount-702](http://Emerson.com/Rosemount/Rosemount-702).
2. Scroll as needed to the green menu bar and click **Documents & Drawings**.
3. Click **Manuals & Guides**.
4. Select the appropriate Quick Start Guide.

## A.2 Ordering Information, Specifications, and Drawings

To view current Rosemount 702 Ordering Information, Specifications, and Drawings, follow these steps:

1. Go to [Emerson.com/Rosemount/Rosemount-702](http://Emerson.com/Rosemount/Rosemount-702).
2. Scroll as needed to the green menu bar and click **Documents & Drawings**.
3. For installation drawings, click **Drawings & Schematics**.
4. Select the appropriate document.

For ordering information, specifications, and dimensional drawings, click **Data Sheets & Bulletins** and select the appropriate Product Data Sheet.



---

# Appendix B High Gain Remote Antenna Option

---

---

Safety messages .....	page 101
Functional specifications .....	page 102
Installation considerations .....	page 103
Transient/lightning considerations .....	page 103
Dimensional drawings .....	page 104
Installing the high gain remote antenna .....	page 105

---

## B.1 Safety messages

Procedures and instructions in this section may require special precautions to ensure the safety of the personnel performing the operations. Information that raises potential safety issues is indicated by a warning symbol (⚠). Refer to the following safety messages before performing an operation preceded by this symbol.

### **⚠ WARNING**

When installing remote mount antennas for the wireless field device, always use established safety procedures to avoid falling or contact with high-power electrical lines.

Install remote antenna components for the wireless field device in compliance with local and national electrical codes and use best practices for lightning protection.

Before installing consult with the local area electrical inspector, electrical officer, and work area supervisor.

The wireless field device remote antenna option is specifically engineered to provide installation flexibility while optimizing wireless performance and local spectrum approvals. To maintain wireless performance and avoid non-compliance with spectrum regulations, do not change the length of cable or the antenna type.

If the supplied remote mount antenna kit is not installed per these instructions, Emerson is not responsible for wireless performance or non-compliance with spectrum regulations.

Be aware of overhead electrical power lines.

---

## B.2 Functional specifications

### Output

WirelessHART® 2.4 GHz DSSS (direct sequence spread spectrum).

Radio frequency power output from antenna:

- High gain remote (WN option) antenna: maximum of 40 mW (16 dBm) EIRP (equivalent isotropically radiated power)

### Communications range

$\frac{2}{3}$  mile (3,300 ft.) (1.0 km) with L.O.S.

### Coaxial length

25 ft. (7.6 m) with type N connections

### Coaxial material

- Heavy duty, low loss LMR400 cable
- Minimum coaxial bend diameter: 1.0 ft. (0.3 m)

### Antenna

- Remote-mount omni directional antenna
- Fiberglass and aluminum construction
- 8 Db Gain
- Meets MIL-STD-810G (method 510.5, procedure I and II)

### Physical specifications

Weight: 1.0 lb (0.4 kg)

### RF lightning arrestor

In-line lightning arrestor

Electrical connection: lightning arrestor MUST be grounded per local electrical codes and regulations.

Mounting bracket

- Horizontal or vertical mast accommodation
- Supported mast diameter: 1.0- to 2.5-in. (2.5 to 6.4 cm)
- Aluminum bracket
- Nickel/zinc plated mounting U-bolts

### Ratings

NEMA® 4X, and IP66/67

### Vibration

3g max vibration

## B.3 Installation considerations

### Antenna mounting

Mount antenna vertically ( $\pm 5^\circ$ )

### Antenna height

mount antenna 14 ft. (4,3 m) above infrastructure with clear line of sight.

### Coaxial cable

Ensure that coaxial cable is securely affixed to the mast to avoid excessive cable movement.

### Installing coaxial drip loop

Ensure a drip loop is installed not closer than 1 ft. (0,3 m) from the transmitter. It may also be convenient to affix the drip loop to the lower portion of the mast ensuring that condensation or rainwater will flow away from the coaxial connections.

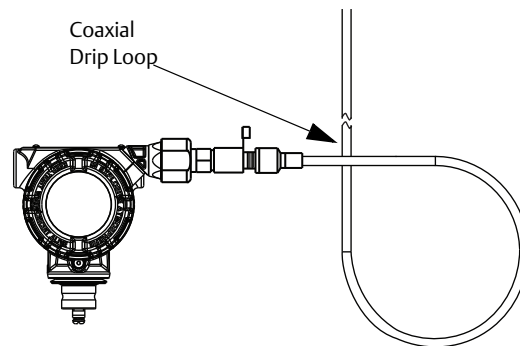

### Applying coaxial sealant moisture protection

Utilize the coaxial sealant that is included in the high gain remote mounting kit package. Follow included instructions for application on the coaxial connection.

## B.4 Transient/lightning considerations

### Gateway transient protection

When installing, consider including transient/lightning protection (not provided) on interface connections (Ethernet, Modbus®, and Coaxial connections) to other equipment.

### RF lightning arrestor ground connection

Ensure grounding connection is made on the RF lightning arrestor ground connection point.

## B.5 Dimensional drawings

Figure B-1. Device Connection and RF Lightning Arrester

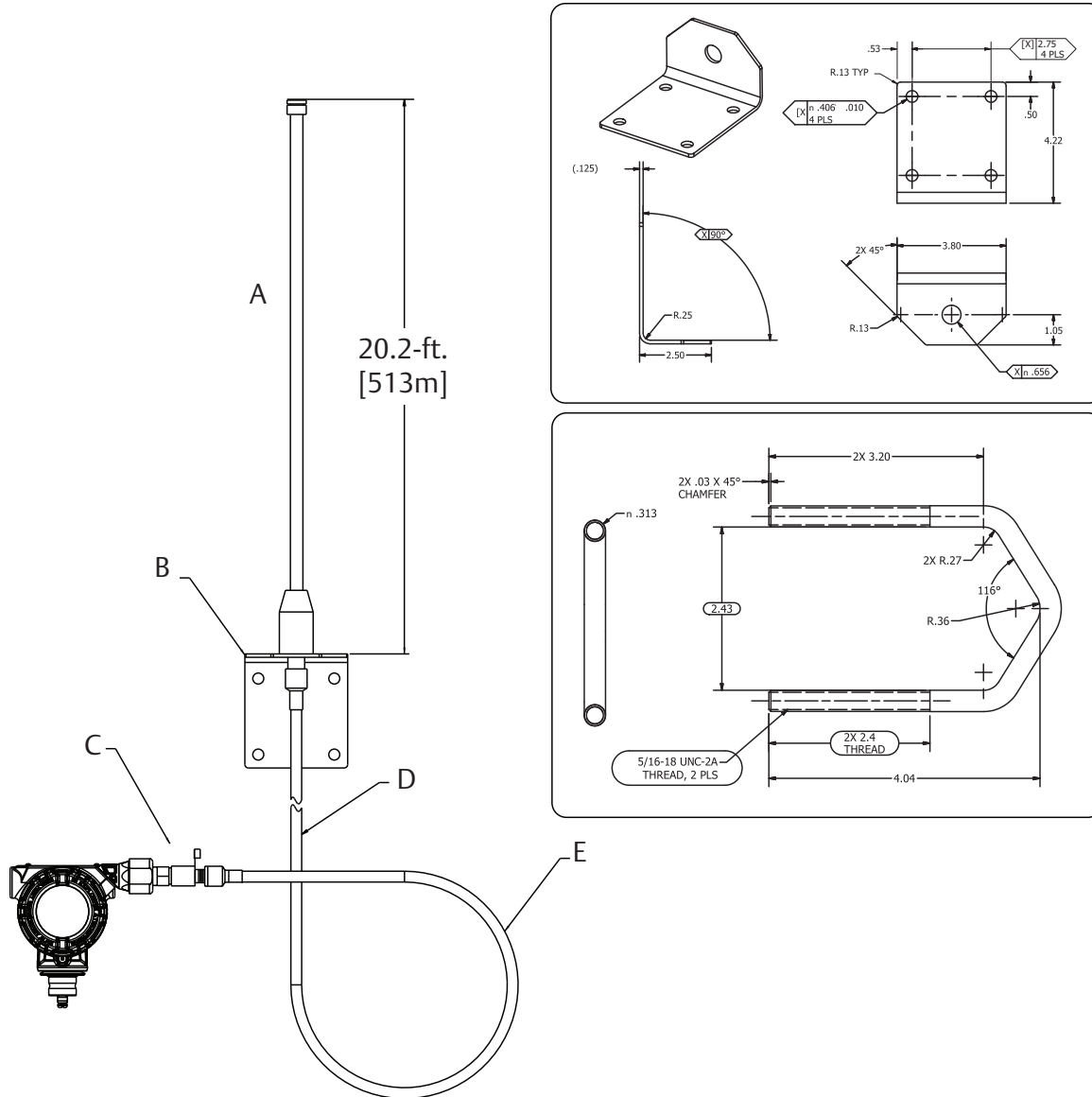

- A. Antenna
- B. Mounting bracket
- C. Mounting arrester
- D. 25 ft. (7.5 m) cable
- E. Min drip loop Ø12-in. (0.3 m)



## B.6 Installing the high gain remote antenna

1. Mount the transmitter following best practice mounting procedures as outlined in the Quick Start Guide and Manual.
2. Connect the RF lightning protector to the device and tighten.

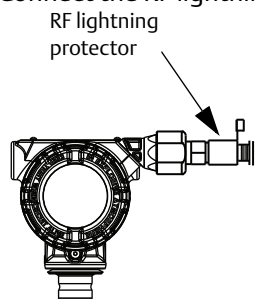

3. Connect antenna to mounting bracket and tighten nut carefully.

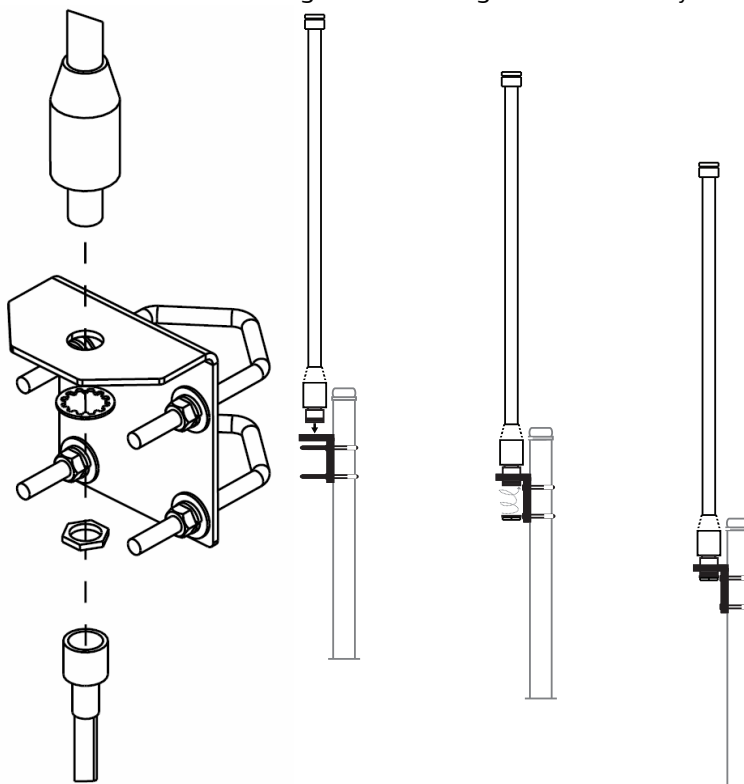

4. Unwind coaxial cable and connect the cable to both the antenna and the lightning protector connected to the transmitter, leaving one loop minimum for a drip loop. Ensure the drip loop is lower than the device, allowing water to flow away from the device.

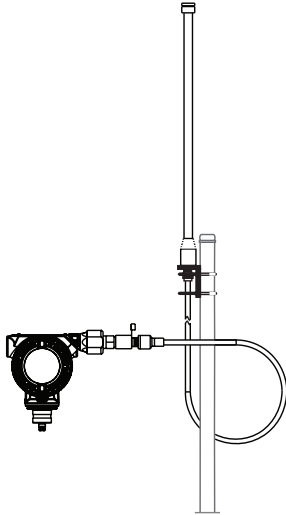

5. Apply the coaxial sealant around each of the coaxial connections and at the lightning arrester, making sure the RF connections are completely sealed.

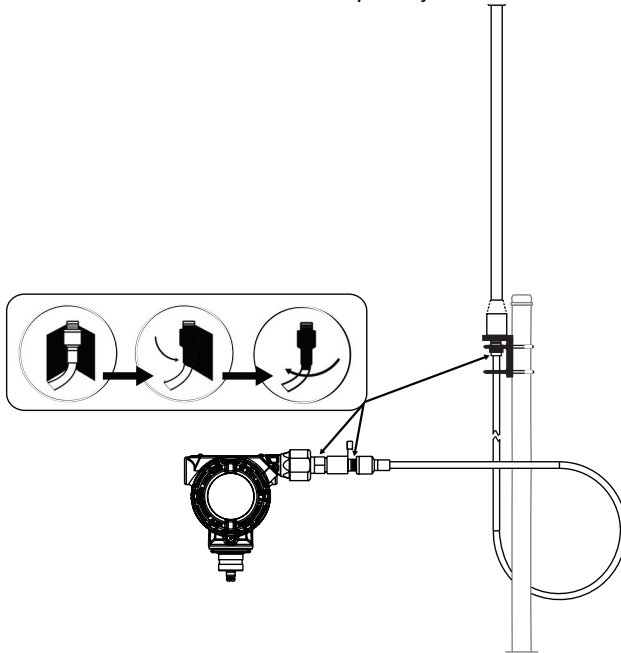

6. Attach U-bolts to mounting bracket in correct orientation ensuring that antenna will be positioned in a vertical position.

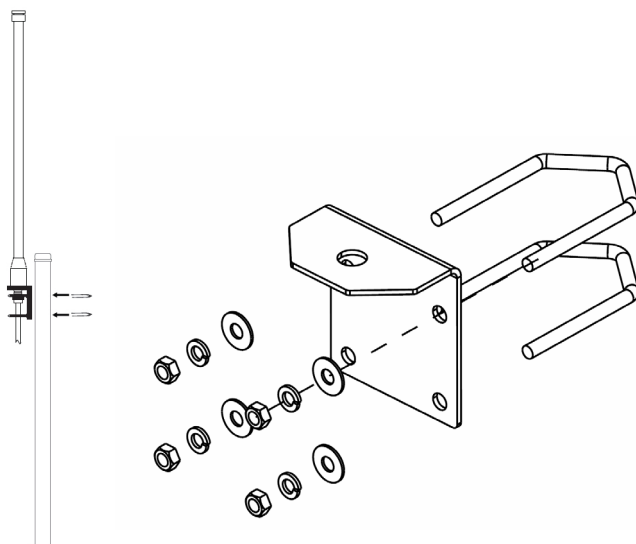

7. Tighten U-bolts to mast and ensure that antenna is pointed in a vertical direction.

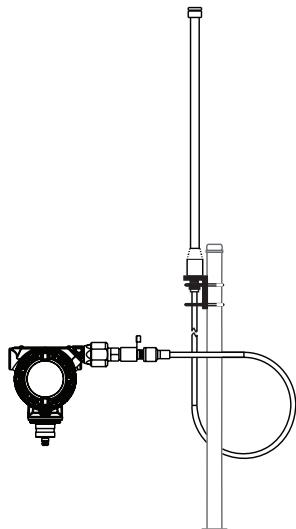



## Appendix C Safety Shower Monitoring

---

Installation instructions .....	page 109
Installation drawings .....	page 111

---

### C.1 Installation instructions

Use these instructions to mount 10 Series GO™ Switches on a universal thermal shower and eyewash.

Refer to [Figure C-1 on page 111](#), [Figure C-2 on page 112](#), and the parts lists for mounting parts identification. Refer to the 10 Series instruction manual for 10 Series parts identification. Refer to the appropriate shower and eyewash instruction manual for shower and eyewash installation, operation, maintenance, and parts identification.

1. Isolate the control valve from the process line pressure, release pressure from both sides of the valve body, and drain the process media from both sides of the valve. Shut off all pressure lines to the shower and eyewash, releasing all pressure from the shower and eyewash. Use lock-out procedures to be sure that the above measures stay in effect while you work on the equipment.
2. Begin shower mounting kit installation by drilling two holes in the shower handle as shown.
3. Attach the target arm to the shower handle using two #10–24 x 0.75 hex head screws, two #10 lock washers, and two #10–24 hex nuts.
4. Loosely attach the target magnet to the target arm using two #10–24 x 0.75 flat head screws, two #10 lock washers, and two #10–24 Hex Nuts.
5. Fasten the two mounting brackets to the shower using the four 1/4–20 x 10.00 threaded studs, eight 1/4-in. plain washers, eight 1/4-in. lock washers, and sixteen 1/4–20 hex nuts.
6. Loosely attach the 10 Series GO Switch to the mounting plate with the hardware provided.
7. Fasten the mounting plate to the mounting brackets with four 1/4–20 x 0.75 hex head screws, four 1/4-in. plain washers, four 1/4-in. lock washers, and four 1/4–20 hex nuts.
8. Adjust the mounting plate, 10 Series GO Switch, and target magnet as needed so that the magnet properly engages the switch. Tighten hardware to hold the mounting plate, 10 Series GO Switch, and target magnet in place.
9. Begin Eyewash mounting installation by loosely attaching the two mounting brackets to the eyewash using the four 1/4–20 x 10.00 threaded studs, eight 1/4” plain washers, eight 1/4” lock washers, and sixteen 1/4–20 hex nuts.

10. Loosely attach the switch mounting bracket to the eyewash mounting brackets with four 1/4-20 x 0.75 hex head screws, four 1/4-in. plain washers, four 1/4-in. lock washers, and four 1/4-20 hex nuts.
11. Loosely attach the 10 Series GO Switch to the switch mounting bracket with the hardware provided.
12. Attach the target magnet to the target arm using two #10-24 x 0.75 flat head screws, two #10 lock washers, and two #10-24 hex nuts.
13. Place the target arm on the face of the eyewash handle and adjust the position of the mounting brackets, 10 Series GO Switch, and target arm so that the target magnet properly engages the switch. Mark the position of the slot of the target arm. Drill two holes in the eyewash handle as shown to be able to attach the target arm.
14. Attach the target arm to the eyewash handle using two #10-24 x 0.50 round head screws, two #10 lock washers, and two #10-24 hex nuts.
15. Tighten hardware to hold the mounting brackets, 10 Series GO Switch, and target arm in place.
16. Set up and calibrate the GO Switches as described in the 10 Series GO Switch operation and installation instructions.
17. Make supply and electrical connections to the GO Switches as described in the 10 Series GO Switch operation and installation instructions.

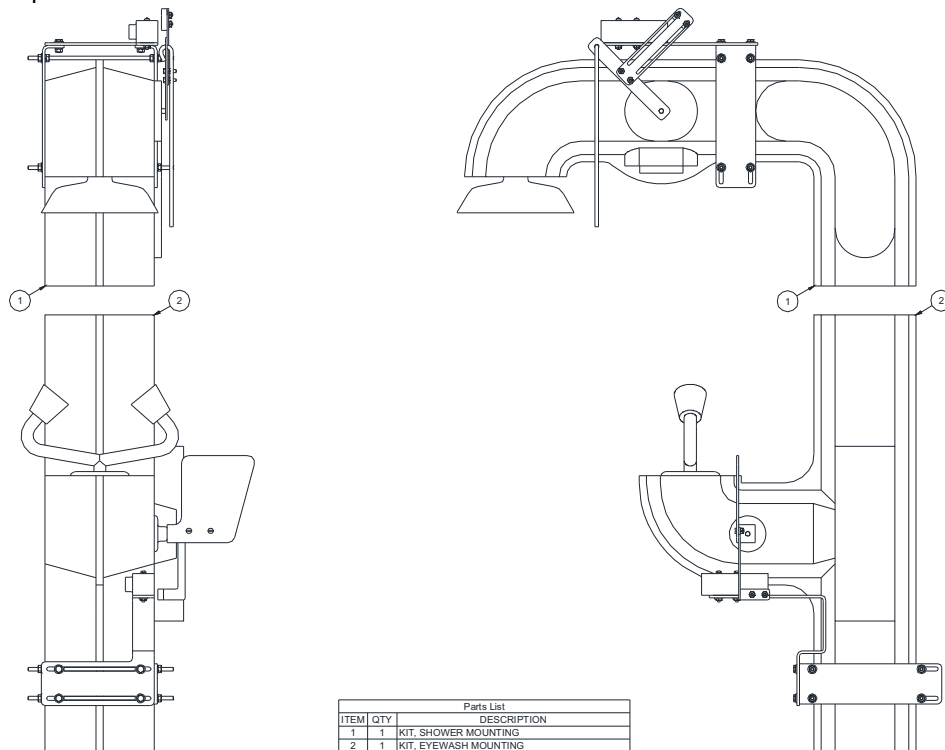

## C.2 Installation drawings

Figure C-1. 10 Series GO Switch Mounted on Universal Thermal Shower

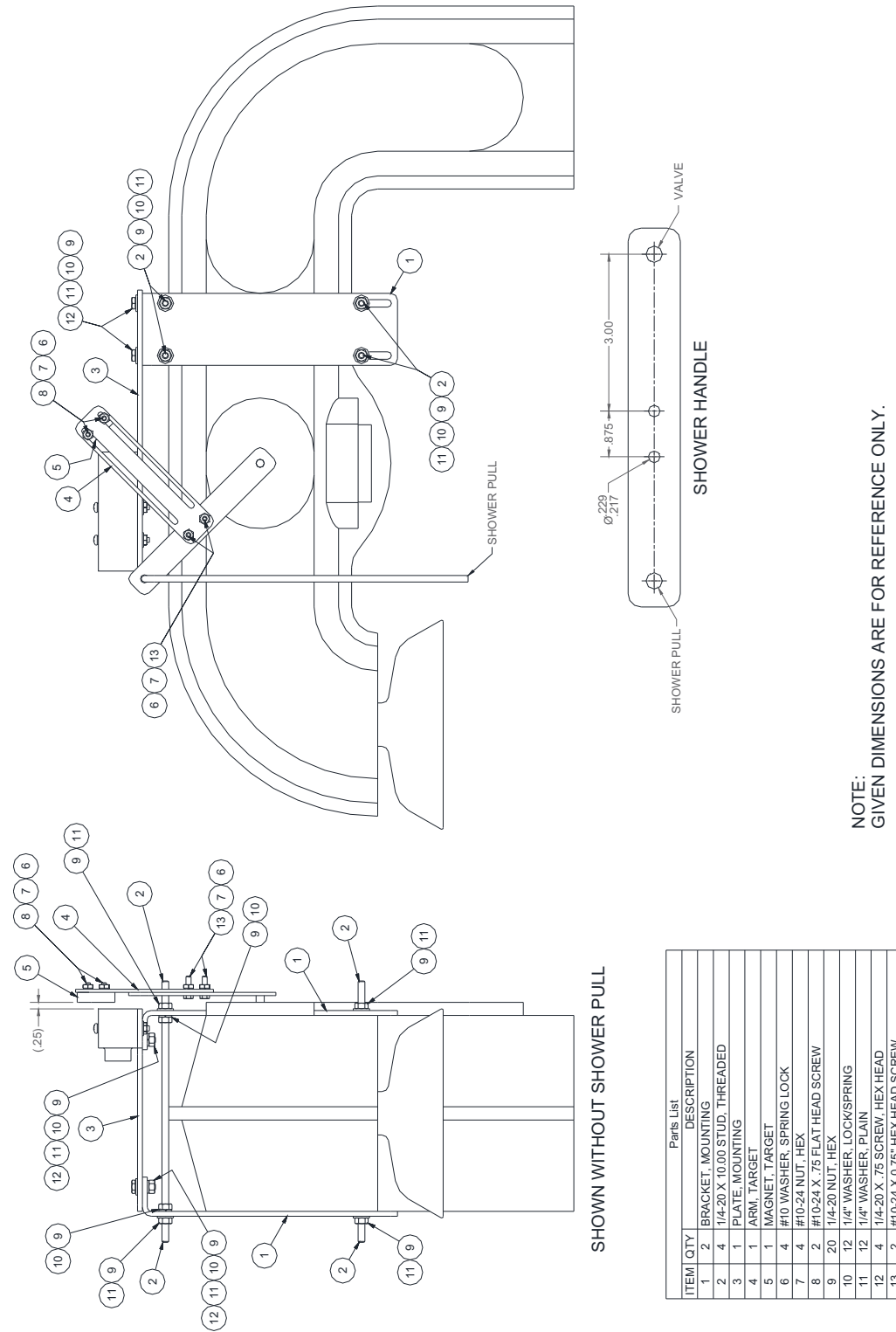
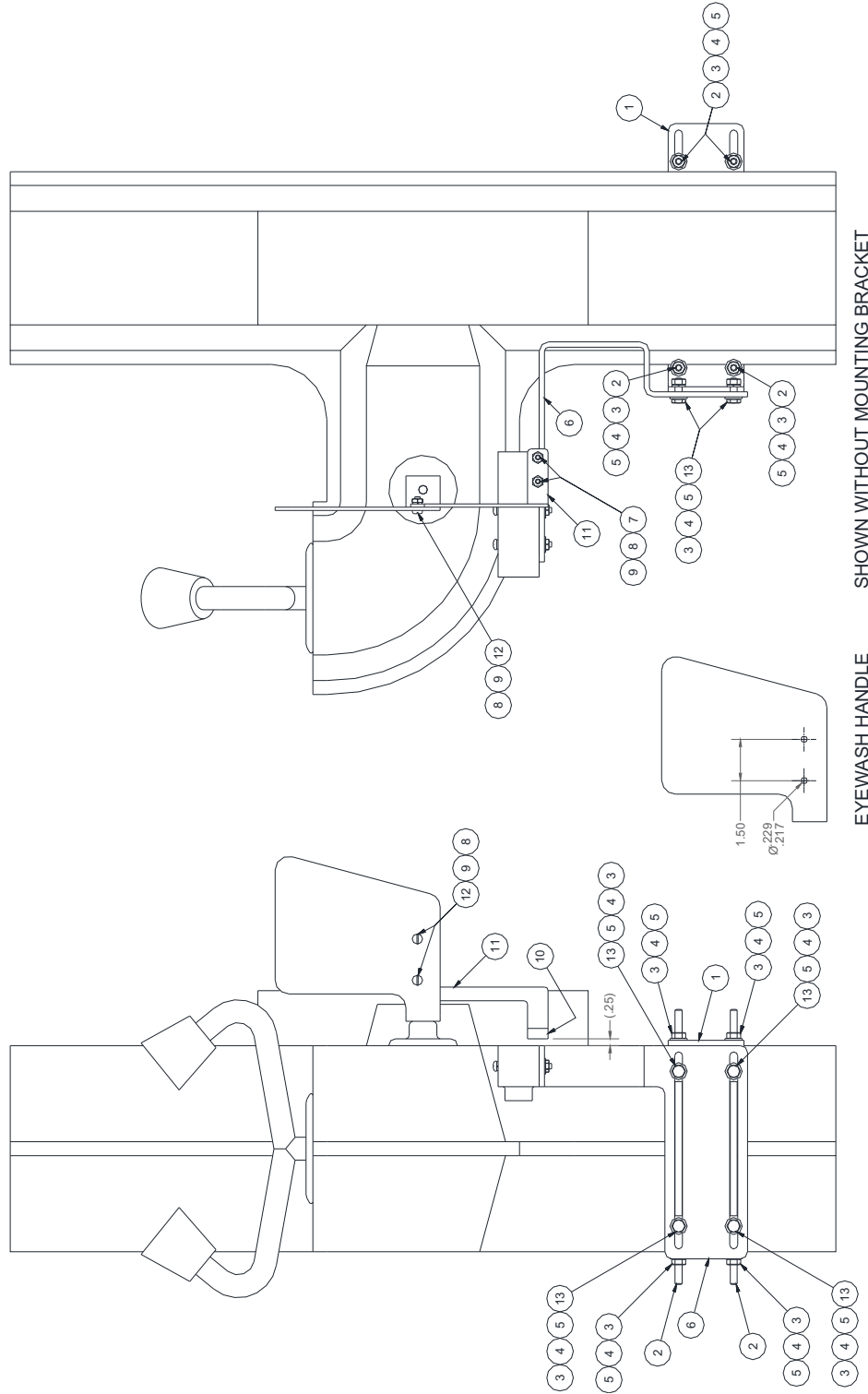

Figure C-2. 10 Series GO Switch Mounted on Universal Thermal Eyewash



NOTE:  
GIVEN DIMENSIONS ARE FOR REFERENCE ONLY.

ITEM	QTY	DESCRIPTION
1	2	BRACKET, MOUNTING
2	4	1/4-20 X .10.00" STUD, THREADED
3	20	1/4-20 NUT, HEX
4	12	1/4" WASHER, PLAIN
5	12	1/4" WASHER, LOCK/SPRING
6	1	BRACKET, MOUNTING
7	2	#10-24 X .75 FLAT HEAD SCREW
8	4	#10-24 NUT, HEX
9	4	#10 WASHER, SPRING LOCK
10	1	MAGNET, TARGET
11	1	ARM, TARGET
12	2	#10-24 X .50 SCREW, ROUND HEAD
13	4	1/4-20 X .75 SCREW, HEX HEAD



Figure C-3. 10 Series GO Switch Universal Shower

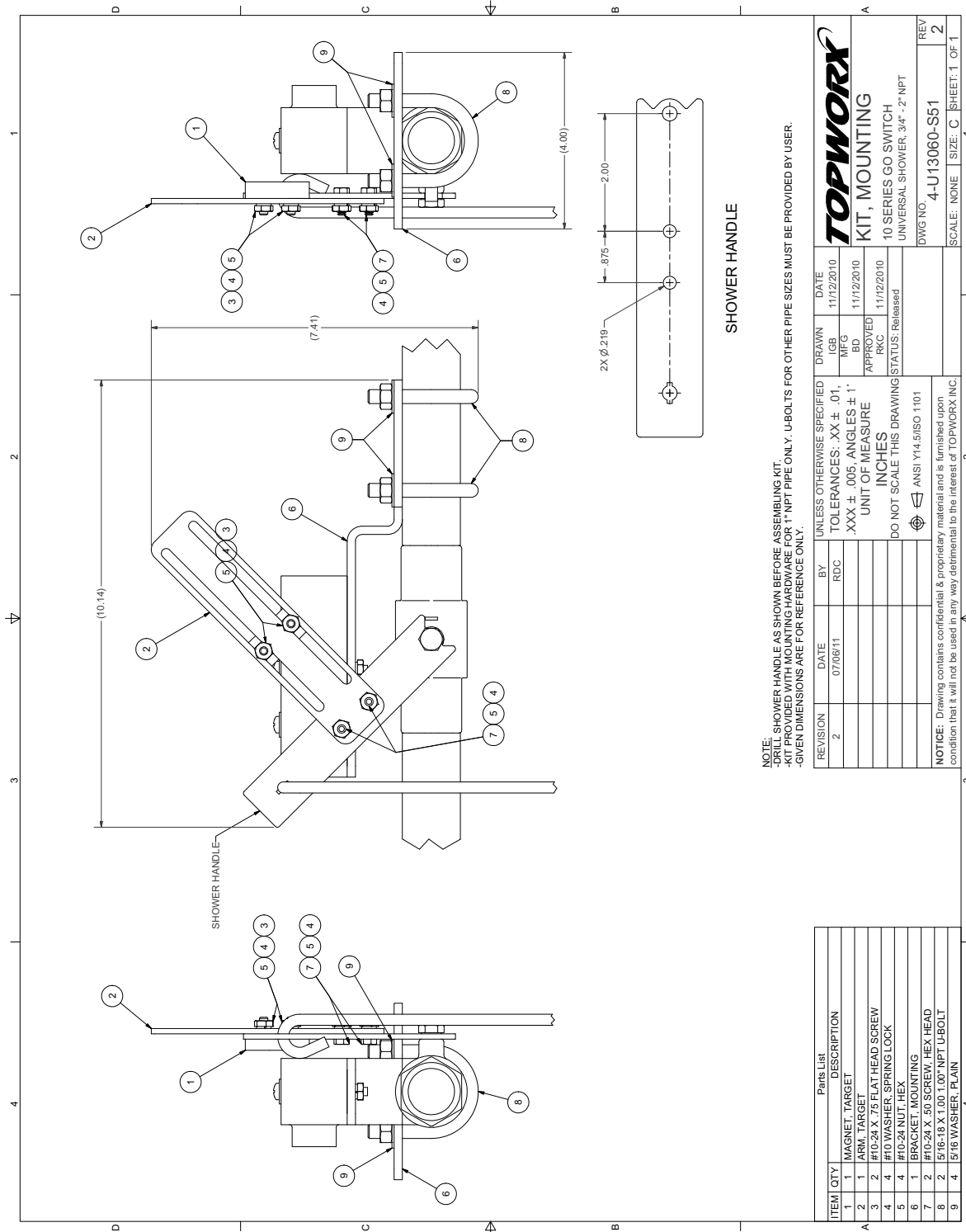

NOTE:  
-DRILL SHOWER HANDLE AS SHOWN BEFORE ASSEMBLING KIT.  
-KIT PROVIDED WITH MOUNTING HARDWARE FOR 1" NPT PIPE ONLY. U-BOLTS FOR OTHER PIPE SIZES MUST BE PROVIDED BY USER.  
-GIVEN DIMENSIONS ARE FOR REFERENCE ONLY.

ITEM QTY		Parts List	
1	1	MAGNET, TARGET	DESCRIPTION
2	1	ARM, TARGET	
3	2	#10-24 X .75 FLAT HEAD SCREW	
4	4	#10 WASHER, SPRING LOCK	
5	4	#10-24 NUT, HEX	
6	1	BRACKET, MOUNTING	
7	2	#10-24 X .50 SCREW, HEX HEAD	
8	2	5/16-18 X 1.00 1.00" NPT U-BOLT	
9	4	5/16 WASHER, PLAIN	

  

REVISION	DATE	BY	UNLESS OTHERWISE SPECIFIED	DRAWN	DATE
2	07/06/11	RDC	TOLERANCES: XX ± .01, .XXX ± .005 ANGLES ± 1°	IGB	11/12/2010
			UNIT OF MEASURE	MFG	11/12/2010
			INCHES	APPROVED	
			DO NOT SCALE THIS DRAWING	RDC	11/12/2010
			ANSI Y14.5/ISO 1101	STATUS: Released	

<b>TOPWORX</b>	
<b>KIT, MOUNTING</b>	
10 SERIES GO SWITCH	
UNIVERSAL SHOWER, 3/4" - 2" NPT	
DWG NO.	4-U113060-S51
REV	2
SCALE:	NONE SIZE: C SHEET: 1 OF 1



Figure C-4. Type 10 Series Switch with or without Latcher

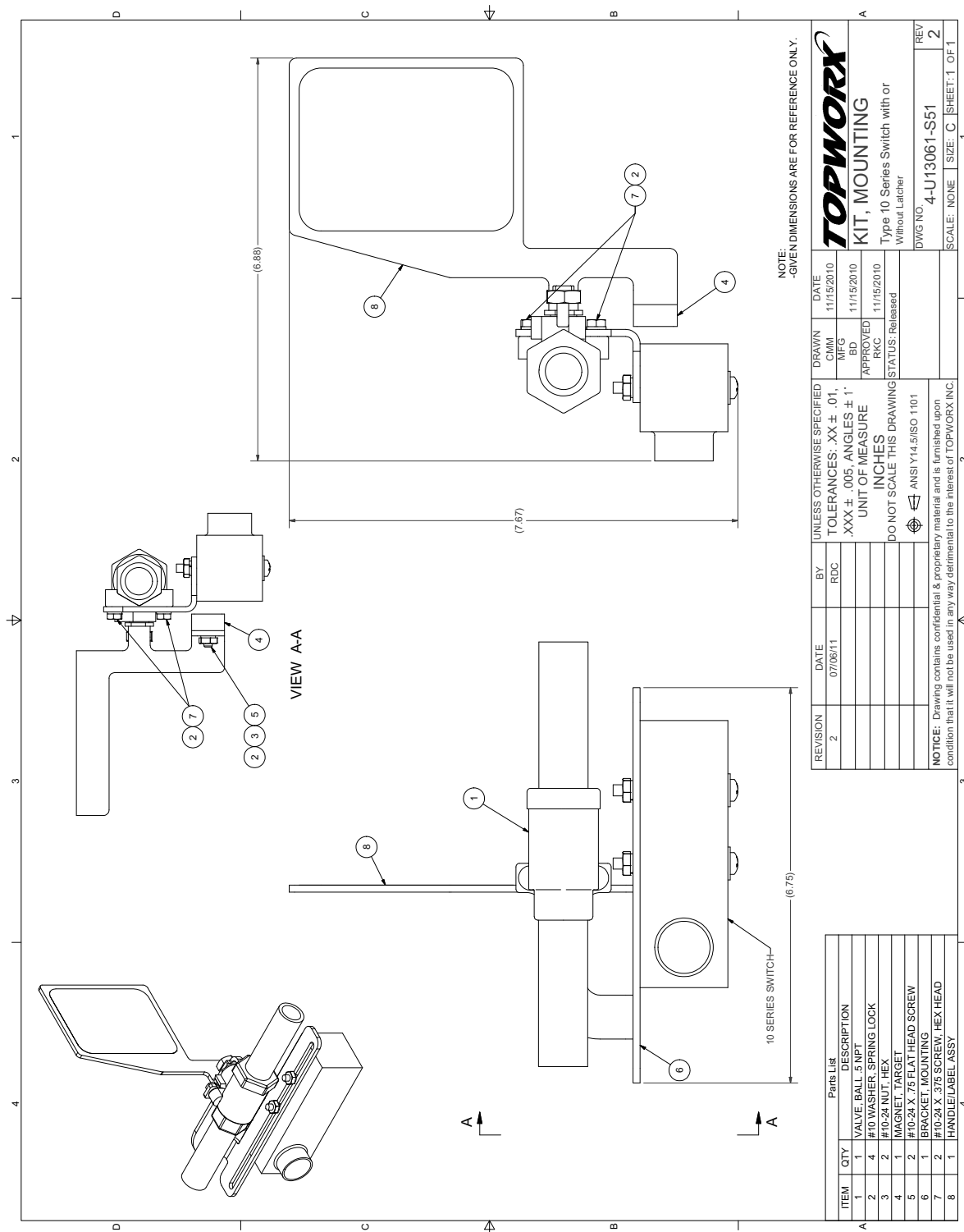





### Global Headquarters

#### Emerson Automation Solutions

6021 Innovation Blvd.  
Shakopee, MN 55379, USA  
 +1 800 999 9307 or +1 952 906 8888  
 +1 952 949 7001  
 RFQ.RMD-RCC@Emerson.com

### North America Regional Office

#### Emerson Automation Solutions

8200 Market Blvd.  
Chanhassen, MN 55317, USA  
 +1 800 999 9307 or +1 952 906 8888  
 +1 952 949 7001  
 RMT-NA.RCCRFQ@Emerson.com



### Latin America Regional Office

#### Emerson Automation Solutions

1300 Concord Terrace, Suite 400  
Sunrise, FL 33323, USA  
 +1 954 846 5030  
 +1 954 846 5121  
 RFQ.RMD-RCC@Emerson.com



### Europe Regional Office

#### Emerson Automation Solutions Europe GmbH

Neuhofstrasse 19a P.O. Box 1046  
CH 6340 Baar  
Switzerland  
 +41 (0) 41 768 6111  
 +41 (0) 41 768 6300  
 RFQ.RMD-RCC@Emerson.com

### Asia Pacific Regional Office

#### Emerson Automation Solutions

1 Pandan Crescent  
Singapore 128461  
 +65 6777 8211  
 +65 6777 0947  
 Enquiries@AP.Emerson.com

### Middle East and Africa Regional Office

#### Emerson Automation Solutions

Emerson FZE P.O. Box 17033  
Jebel Ali Free Zone - South 2  
Dubai, United Arab Emirates  
 +971 4 8118100  
 +971 4 8865465  
 RFQ.RMTMEA@Emerson.com

 [Linkedin.com/company/Emerson-Automation-Solutions](https://www.linkedin.com/company/Emerson-Automation-Solutions)

 [Twitter.com/Rosemount\\_News](https://twitter.com/Rosemount_News)

 [Facebook.com/Rosemount](https://www.facebook.com/Rosemount)

 [Youtube.com/user/RosemountMeasurement](https://www.youtube.com/user/RosemountMeasurement)

 [Google.com/+RosemountMeasurement](https://www.google.com/+RosemountMeasurement)

Standard Terms and Conditions of Sale can be found on the [Terms and Conditions of Sale page](#).

The Emerson logo is a trademark and service mark of Emerson Electric Co. Rosemount is a mark of one of the Emerson family of companies. All other marks are the property of their respective owners.  
© 2018 Emerson. All rights reserved.