

**Data sheet**

Sheet No.: D114, Rev. B

Date: June 2005

**Hytork XL**

# Envelope Dimensions

## XL2586 / XL4581 Actuators with Stop Blocks (Metric)

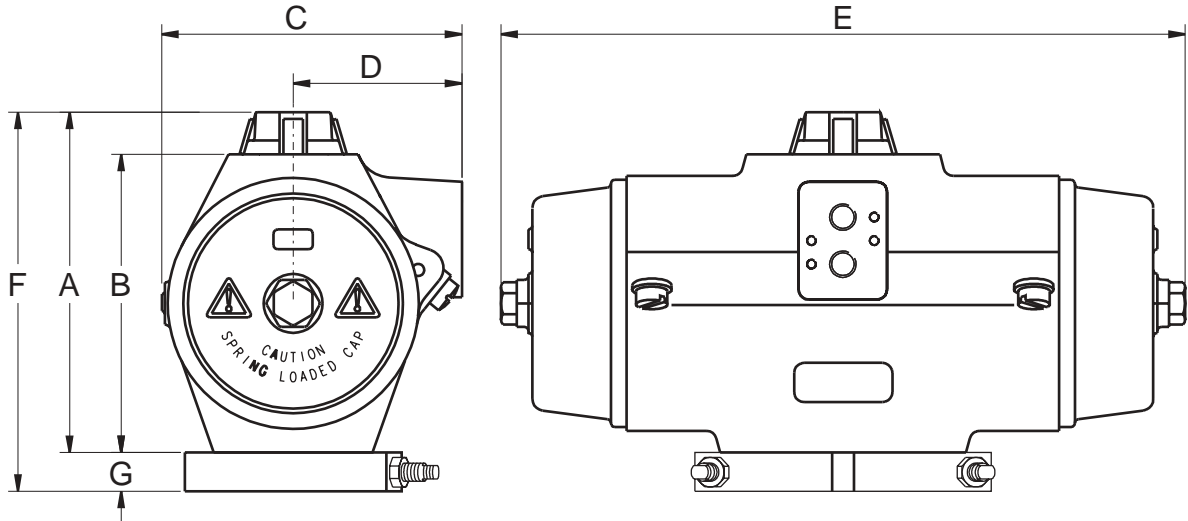

**Spring Return Units**

Models	A	B	C	D	E	F	G
XL2586	292.0	260.0	253.0	131.0	862.0	338.0	46.0
XL4581	388.0	356.0	321.0	160.0	884.0	434.0	46.0

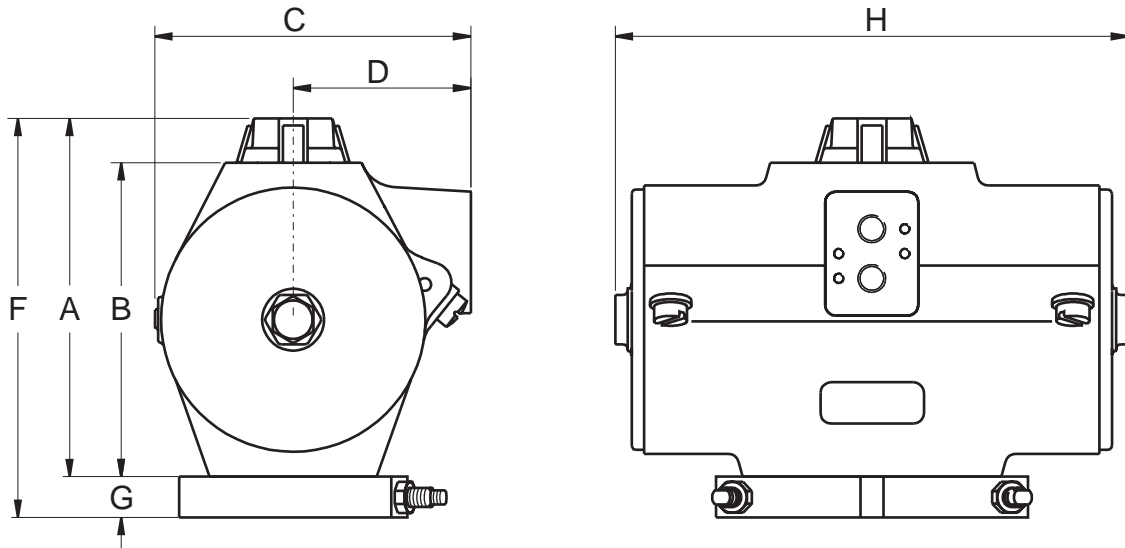

**Double Acting Units**

Models	A	B	C	D	H	F	G
XL2586	292.0	260.0	253.0	131.0	467.0	337.0	46.0
XL4581	388.0	356.0	321.0	160.0	515.0	433.0	46.0



www.Hytork.com

Copyright © Emerson Process Management. The information in this document is subject to change without notice. Updated data sheets can be obtained from our website [www.hytork.com](http://www.hytork.com) or from your nearest Valve Automation Center  
 USA: +1 813 630 2255 (fax 630 9449) UK: +44 191 5180020 (fax 5180032)



**EMERSON**  
 Process Management