

Hydraulic double-acting balanced rotary actuator 90° quarter-turn

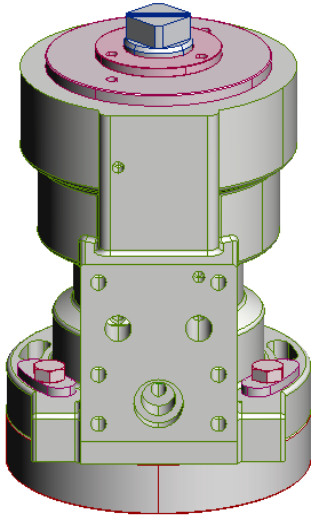

Main data:

Working pressure:	135 bar	(1958 psi)
Burst test:	675 bar	(9788 psi)
Total dry wt. incl. 3.1 kg: (6.8 lbs.) mounting set	13.0 kg	(28.6 lbs.)
Oil displacement:	0.102 l	(6.2 cu. in.)
Temperature range:	-20°C to +80°C	(-5° F to +180° F)
Rotation:	90°±1°	
Hydraulic media and viscosities:	We recommend acid-free hydraulic oil. Viscosity range: 15-200 cSt. For recommended brands and for other media than oil please refer to separate data sheet.	

Main dimensions:

Actuator shown in closed position.

Dimensions in inches shown in parentheses.

A port: Close (clockwise seen from above).

B port: Open.

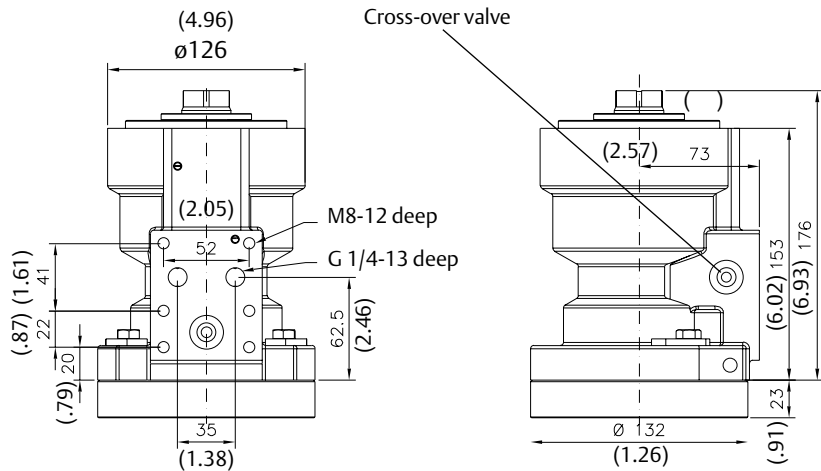

Valve adaptation:

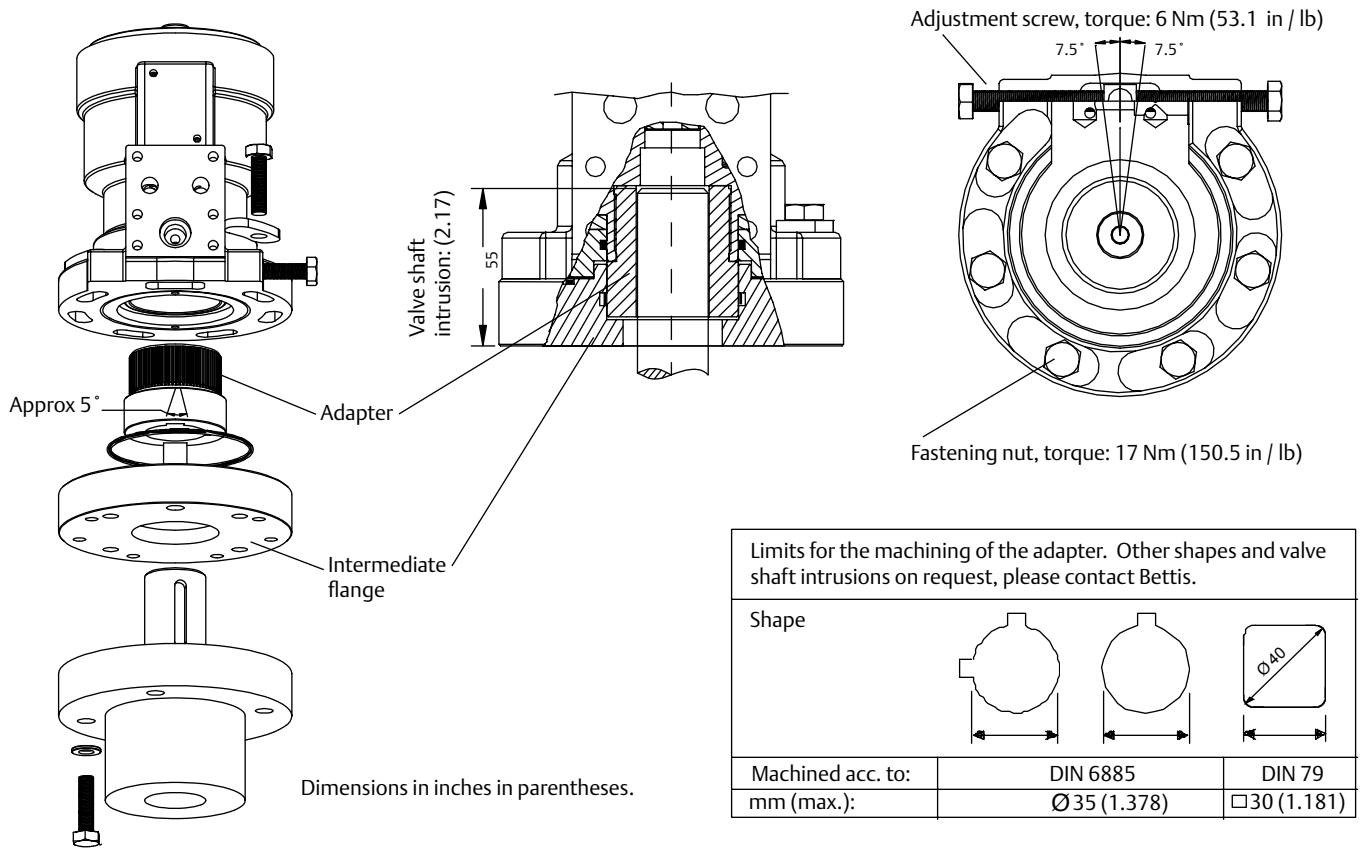

Performance:

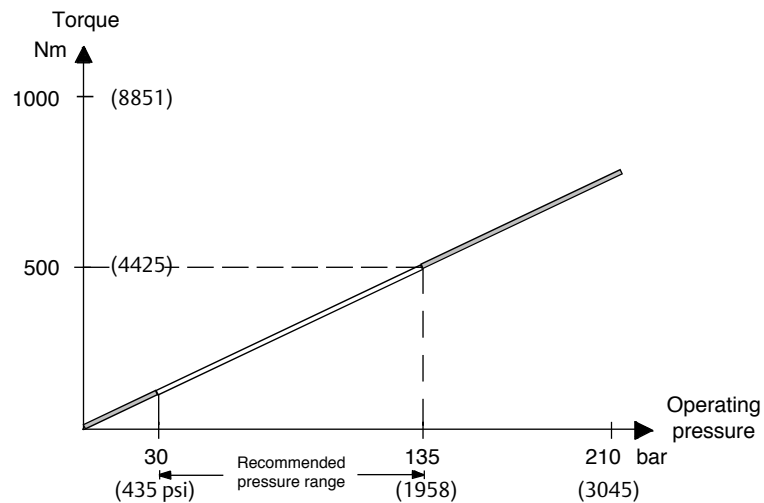

Note: Not Certified dimensional drawings. Such drawings are available on request. Contact factory with correct model designation and serial number.
 Important: Due to Emerson's continuing commitment to engineered product advancement, data presented herein is subject to change.

The contents of the publication are presented for information purposes only, and while effort has been made to ensure their accuracy, they are not to be construed as warranties or guarantees, express or implied, regarding the products or services described herein or their use or applicability. All sales are governed by our terms and conditions, which are available on request.
 We reserve the right to modify or improve the designs or specifications of our products at any time without notice.