

# Rosemount™ 2051G Pressure Transmitter

with 4-20 mA HART® Protocol (Revision 5 and 7)



**Contents**

About this guide..... 3

System readiness..... 5

Mount the transmitter.....6

Set the switches..... 9

Connect the wiring and power up.....10

Verify transmitter configuration..... 13

Trim the transmitter.....19

Safety instrumented systems..... 22

Product certifications..... 23

# 1 About this guide

This guide provides basic guidelines for Rosemount™ 2051G Transmitters. It does not provide instructions for configuration, diagnostics, maintenance, service, troubleshooting, Explosion-proof, Flameproof, or intrinsically safe (I.S.) installations. See the Rosemount 2051G [Reference Manual](#) for more information.

## **⚠ WARNING**

### **Explosions could result in death or serious injury.**

Installation of these transmitters in an explosive environment must be in accordance with the appropriate local, national, and international standards, codes, and practices. Review the approvals section of the Rosemount 2051 Reference Manual for any restrictions associated with a safe installation.

Before connecting a HART-based communicator in an explosive atmosphere, make sure the instruments in the loop are installed in accordance with intrinsically safe or non-incendive field wiring practices.

In an explosion-proof/flameproof installation, do not remove the transmitter covers when power is applied to the unit.

### **Process leaks could result in death or serious injury.**

To avoid process leaks, only use the O-ring designed to seal with the corresponding flange adapter.

### **Electrical shock could cause death or serious injury.**

Avoid contact with the leads and terminals. High voltage that may be present on leads can cause electrical shock.

### **Conduit/cable entries**

Unless marked, the conduit/cable entries in the transmitter housing use a ½–14 NPT thread form. Entries marked “M20” are M20 × 1.5 thread form. On devices with multiple conduit entries, all entries will have the same thread form. Only use plugs, adapters, glands, or conduit with a compatible thread form when closing these entries.

---

**⚠ WARNING****Physical access**

Unauthorized personnel may potentially cause significant damage to and/or misconfiguration of end users' equipment. This could be intentional or unintentional and needs to be protected against.

Physical security is an important part of any security program and fundamental to protecting your system. Restrict physical access by unauthorized personnel to protect end users' assets. This is true for all systems used within the facility.

---

## 2 System readiness

### 2.1 Confirm HART Revision capability

- If using HART® based control or asset management systems, confirm the HART capability of those systems prior to transmitter installation. Not all systems are capable of communicating with HART Revision 7. This transmitter can be configured for either HART Revision 5 or 7.
- For instructions on how to change the HART revision of the transmitter, see [Switch HART revision mode](#).

### 2.2 Confirm correct device driver

#### Procedure

1. Verify the latest Device Driver (DD/DTM™) is loaded on your systems to ensure proper communications.
2. Reference [Emerson.com](#) or [FieldCommGroup.org](#) for the latest DD.
3. Select desired product and download the DD.
  - a) Reference [Table 2-1](#) for the correct DD.

**Table 2-1: Device Revisions and Files**

|                       | Identify device                        |  |                                       | Find device driver files |                                | Review instructions              | Review functionality               |
|-----------------------|--|--|---------------------------------------|--------------------------|--------------------------------|----------------------------------|------------------------------------|
| Software release date | NAMUR hardware revision <sup>(1)</sup> | NAMUR software revision <sup>(1)</sup> | HART software revision <sup>(2)</sup> | HART universal revision  | Device revision <sup>(3)</sup> | 00809-04 00-4101                 | Changes to software <sup>(4)</sup> |
| June 2016             | 1.1.xx                                 | 1.0.xx                                 | 03                                    | 7<br>5                   | 10<br>9                        | <a href="#">Reference Manual</a> | <sup>(4)</sup>                     |

- (1) NAMUR revision is located on the hardware tag of the device. Differences in level 3 changes, signified above by xx, represent minor product changes as defined per NE53. Compatibility and functionality are preserved and product can be used interchangeably.
- (2) HART software revision can be read using a HART capable configuration tool. Value shown is minimum revision that could correspond to NAMUR revisions.
- (3) Device driver file names use device and DD revision (e.g. 10\_01). HART Protocol is designed to enable legacy device driver revisions to continue to communicate with new HART devices. To access new functionality, the new device driver must be downloaded. It is recommended to download new device driver files to ensure full functionality.
- (4) HART Revision 5 and 7 selectable, Local Operator Interface (LOI), scaled variable, configurable alarms, expanded engineering units. Updated electronics hardware design. Intrinsically Safe temperature classification change.

### 3 Mount the transmitter

Mount directly to the impulse line without using an additional mounting bracket or mount directly to a wall, panel, or two-inch pipe using an optional mounting bracket.

**Figure 3-1: Transmitter Direct Mounting**

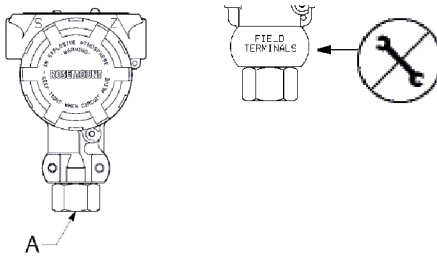

A. Process connection

#### Note

Do not apply torque directly to the electronics housing. To avoid damage, apply torque only to the hex-shaped process connection.

**Figure 3-2: Panel and Pipe Mounting**

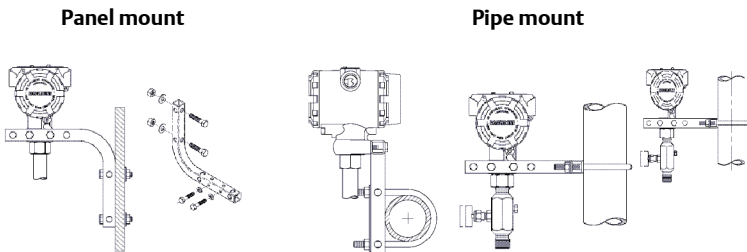

### 3.1 Liquid flow applications

#### Procedure

1. Place taps to the side of the line.
2. Mount beside or below the taps.
3. Mount the transmitter so the drain/vent valves are oriented upward.

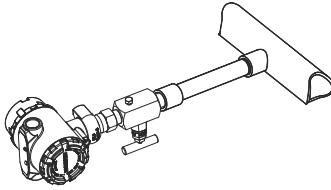

## 3.2 Gas flow applications

### Procedure

1. Place taps in the top or side of the line.
2. Mount level or above the taps.

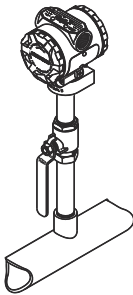

## 3.3 Steam flow applications

### Procedure

1. Place taps to the side of the line.
2. Mount beside or below the taps.
3. Fill impulse lines with water.

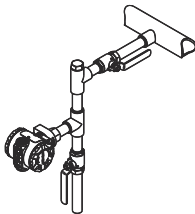

## 3.4 Environmental seal for housing

Thread sealing (PTFE) tape or paste on male threads of conduit is required to provide a water/dust tight conduit seal and meets requirements of NEMA<sup>®</sup> Type 4X, IP66, and IP68. Consult factory if other ingress protection ratings are required.

For M20 threads, install conduit plugs to full thread engagement or until mechanical resistance is met.

### 3.5 Gage transmitter orientation

The low side pressure port (atmospheric reference) on the inline gage transmitter is located in the neck of the transmitter, behind the housing. The vent path is 360° around the transmitter between the housing and sensor. (See [Figure 3-3](#)).

#### **▲ CAUTION**

Keep the vent path free of any obstruction, including but not limited to paint, dust, and lubrication by mounting the transmitter so the contaminants can drain away.

**Figure 3-3: Gage Low Side Pressure Port**

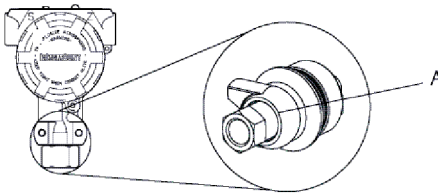

**A** Low side pressure port (atmospheric reference)



## 4 Set the switches

Set alarm and security switch configuration before installation as shown in Figure 4-1.

- The alarm switch sets the analog output alarm to high or low. Default alarm is high.
- The security switch allows (🔓) or prevents (🔒) any configuration of the transmitter. Default security is off (🔓).

Use the following procedure to change the switch configuration:

### Procedure

1. If the transmitter is installed, secure the loop, and remove power.
2. Remove the housing cover opposite the field terminal side. Do not remove the instrument cover in explosive atmospheres when the circuit is live.
3. Slide the security and alarm switches into the preferred position using a small screwdriver.
4. Reattach the transmitter cover. The cover must be fully engaged to comply with explosion-proof requirements.

**Figure 4-1: Transmitter Electronics Board**

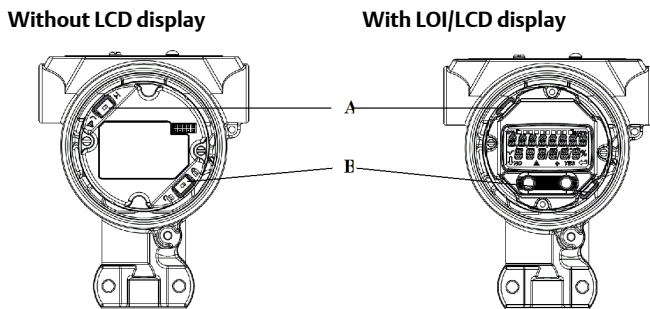

- A. Alarm  
B. Security

## 5 Connect the wiring and power up

### ⚠ CAUTION

Do not tamper with or remove the electronics board in the Rosemount™ 2051G. This will cause permanent damage to the transmitter.

Shielded twisted pair cable should be used for best results. Use 24 AWG or larger wire that does not exceed 5000 ft. (1500 m) in length. If applicable, install wiring with a drip loop. Arrange the drip loop so the bottom is lower than the conduit connections and the transmitter housing.

**Figure 5-1: Wiring the Transmitter (4–20 mA HART)**

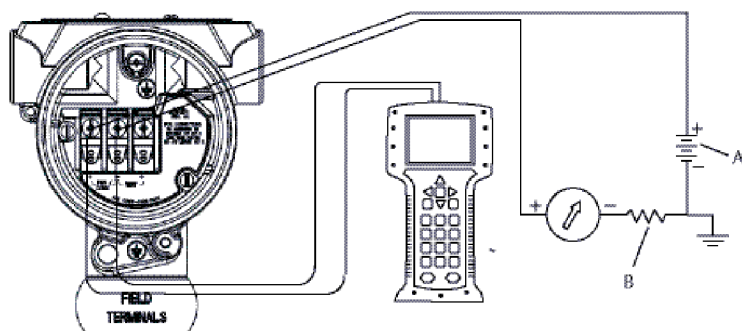

**A** Vdc supply

**B**  $R_L \geq 250$  (necessary for HART® communication only)

### ⚠ CAUTION

Installation of the transient protection terminal block does not provide transient protection unless the transmitter case is properly grounded.

Do not run signal wiring in conduit or open trays with power wiring, or near heavy electrical equipment.

Do not connect the powered signal wiring to the test terminals. Power could damage the test diode in the terminal block.

Use the following steps to wire the transmitter:

#### Procedure

1. Remove the housing cover on the FIELD TERMINALS side.

2. Connect the leads as shown in [Figure 5-1](#).
3. Tighten the terminal screws to ensure full contact with the terminal block screw and washer. When using a direct wiring method, wrap wire clockwise to ensure it is in place when tightening the terminal block screw.

---

**Note**

The use of a pin or ferrule wire terminal is not recommended as the connection may be more susceptible to loosening over time or under vibration.

---

4. Ground housing to fulfill local grounding regulations.
5. Ensure proper grounding. It is important that the instrument cable shield:
  - Be trimmed close and insulated from touching the transmitter housing
  - Be connected to the next shield if cable is routed through a junction box
  - Be connected to a good earth ground at the power supply end
6. If transient protection is needed, refer to [Grounding for transient terminal block](#) section for grounding instructions.
7. Plug and seal unused conduit connections.
8. Replace the housing cover.

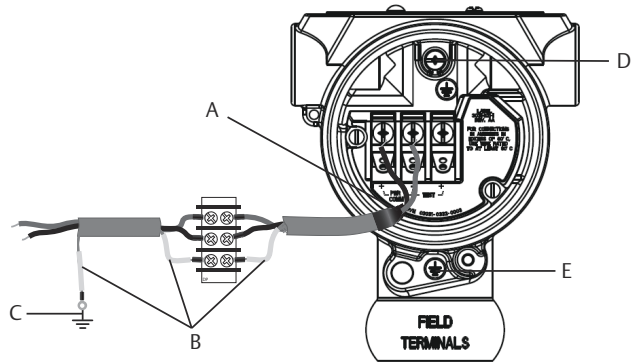
**Figure 5-2: Grounding**

- A. Trim shield and insulate
- B. Insulate shield
- C. Terminate cable shield drain wire to earth ground
- D. Internal ground location
- E. External ground location

## 5.1 Grounding for transient terminal block

Ground termination is provided on the outside of the electronics housing and inside the terminal compartment. These grounds are used when the transient protection terminal blocks are installed. It is recommended that 18 AWG or larger wire is used to connect housing ground to earth ground (internal or external).

If the transmitter is currently not wired for power up and communication, follow [Connect the wiring and power up](#). When the transmitter is properly wired, refer to [Figure 5-2](#) for internal and external transient grounding locations.

## 6 Verify transmitter configuration

Verify the configuration using any HART® capable configuration tool or LOI - option code M4. Configuration instructions for a Field Communicator and LOI are included in this step. See Rosemount™ 2051 [Reference Manual](#) for configuration instructions using AMS Device Manager.

### 6.1 Verifying configuration with a Field Communicator

A Rosemount™ 2051 DD must be installed on the Field Communicator to verify configuration. Fast Key sequences vary depending on device and DD revisions. Use the [Determine Fast Key sequence table](#) process below to identify the appropriate Fast Key sequences.

### 6.2 Field Communicator user interface

#### 6.2.1 Determine Fast Key sequence table

##### Procedure

1. Connect Field Communicator to Rosemount™ 2051G.
2. If *Home* screen matches [Figure 6-1](#), refer to [Table 6-1](#) for Fast Key sequences.
3. If *Home* screen matches [Figure 6-2](#):
  - a) Perform Fast Key sequence 1, 7, 2 to identify Field Revision and HART® Revision.
  - b) Refer to [Table 6-2](#) and the appropriate column based on your Field Revision and HART Revision for Fast Key sequences.

---

##### Note

Emerson recommends installing the latest DD to access the complete functionality. Visit [Emerson.com](http://Emerson.com) or [FieldCommGroup.org](http://FieldCommGroup.org).

---

**Figure 6-1: Traditional Interface**

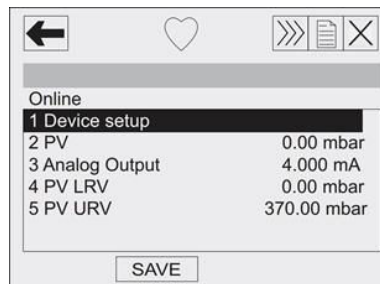

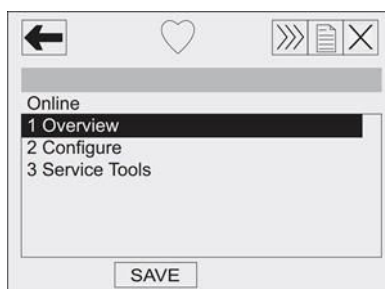
**Figure 6-2: Device Dashboard****Note**

A check (✓) indicates the basic configuration parameters. At minimum, these parameters should be verified as part of the configuration and startup procedure.

**Table 6-1: Traditional Interface Fast Keys**

|   | Function                                | Fast Key sequence |
|---|---|-------------------|
| ✓ | Analog Output Alarm                     | 1,4,3,2,4         |
|   | Burst Mode Control                      | 1,4,3,3,3         |
|   | Burst Option                            | 1,4,3,3,4         |
|   | Calibration                             | 1,2,3             |
| ✓ | Damping                                 | 1,3,5             |
|   | Date                                    | 1,3,4,1           |
|   | Descriptor                              | 1,3,4,2           |
|   | Digital To Analog Trim (4–20 mA Output) | 1,2,3,2,1         |
|   | Disable Local Span/Zero Adjustment      | 1,4,4,1,7         |
|   | Field Device Info                       | 1,4,4,1           |
|   | Keypad Input                            | 1,2,3,1,1         |
|   | Loop Test                               | 1,2,2             |
|   | Lower Range Value                       | 4,1               |
|   | Lower Sensor Trim                       | 1,2,3,3,2         |
|   | Message                                 | 1,3,4,3           |
|   | Meter Type                              | 1,3,6,1           |
|   | Number of Requested                     | 1,4,3,3,2         |

**Table 6-1: Traditional Interface Fast Keys (continued)**

|   | Function                             | Fast Key sequence |
|---|--------------------------------------|-------------------|
|   | Output Trim                          | 1,2,3,2           |
|   | Percent Range                        | 1,1,2             |
|   | Poll Address                         | 1,4,3,3,1         |
| ✓ | Range Values                         | 1,3,3             |
|   | Rerange                              | 1,2,3,1           |
|   | Scaled D/A Trim (4–20 mA)            | 1,2,3,2,2         |
|   | Self Test (Transmitter)              | 1,2,1,1           |
|   | Sensor Info                          | 1,4,4,2           |
|   | Sensor Trim (Full Trim)              | 1,2,3,3           |
|   | Sensor Trim Points                   | 1,2,3,3,5         |
|   | Status                               | 1,2,1,2           |
| ✓ | Tag                                  | 1,3,1             |
|   | Transmitter Security (Write Protect) | 1,3,4,4           |
| ✓ | Units (Process Variable)             | 1,3,2             |
|   | Upper Range Value                    | 5,2               |
|   | Upper Sensor Trim                    | 1,2,3,3,3         |
|   | Zero Trim                            | 1,2,3,3,1         |

**Note**

A check (✓) indicates the basic configuration parameters. At minimum, these parameters should be verified as part of the configuration and startup procedure.

**Table 6-2: Device Dashboard Fast Keys**

|   | Function                    | Fast Key sequence |           |           |
|---|-----------------------------|-------------------|-----------|-----------|
|   | Field Revision              | Rev 3             | Rev 5     | Rev 7     |
|   | HART Revision               | HART 5            | HART 5    | HART 7    |
| ✓ | Alarm and Saturation Levels | N/A               | 2,2,2,5,7 | 2,2,2,5,7 |
| ✓ | Damping                     | 2,2,1,2           | 2,2,1,1,5 | 2,2,1,1,5 |
| ✓ | Range Values                | 2,2,2             | 2,2,2     | 2,2,2     |
| ✓ | Tag                         | 2,2,6,1,1         | 2,2,7,1,1 | 2,2,7,1,1 |

**Table 6-2: Device Dashboard Fast Keys (continued)**

|   | Function                                  | Fast Key sequence |           |           |
|---|---|-------------------|-----------|-----------|
|   | Field Revision                            | Rev 3             | Rev 5     | Rev 7     |
|   | HART Revision                             | HART 5            | HART 5    | HART 7    |
| ✓ | Transfer Function                         | 2,2,1,3           | 2,2,1,1,6 | 2,2,1,1,6 |
| ✓ | Units                                     | 2,2,1,1           | 2,2,1,1,4 | 2,2,1,1,4 |
|   | Burst Mode                                | 2,2,4,1           | 2,2,5,3   | 2,2,5,3   |
|   | Custom Display Configuration              | 2,2,3             | 2,2,4     | 2,2,4     |
|   | Date                                      | 2,2,6,1,4         | 2,2,7,1,3 | 2,2,7,1,4 |
|   | Descriptor                                | 2,2,6,1,5         | 2,2,7,1,4 | 2,2,7,1,5 |
|   | Digital to Analog Trim (4-20 mA Output)   | 3,4,2             | 3,4,2     | 3,4,2     |
|   | Disable Configuration Buttons             | 2,2,5,2           | 2,2,6,3   | 2,2,6,3   |
|   | Rerange with Keypad                       | 2,2,2             | 2,2,2,1   | 2,2,2,1   |
|   | Loop Test                                 | 3,5,1             | 3,5,1     | 3,5,1     |
|   | Upper Sensor Trim                         | 3,4,1,1           | 3,4,1,1   | 3,4,1,1   |
|   | Lower Sensor Trim                         | 3,4,1,2           | 3,4,1,2   | 3,4,1,2   |
|   | Message                                   | 2,2,6,1,5         | 2,2,7,1,5 | 2,2,7,1,6 |
|   | Sensor Temperature/Trend                  | 3,3,2             | 3,3,3     | 3,3,3     |
|   | Digital Zero Trim                         | 3,4,1,3           | 3,4,1,3   | 3,4,1,3   |
|   | Password                                  | N/A               | 2,2,6,4   | 2,2,6,5   |
|   | Scaled Variable                           | N/A               | 3,2,2     | 3,2,2     |
|   | HART Revision 5 to HART Revision 7 switch | N/A               | 2,2,5,2,3 | 2,2,5,2,3 |
|   | Long Tag                                  | N/A               | N/A       | 2,2,7,1,2 |
|   | Find Device                               | N/A               | N/A       | 3,4,5     |
|   | Simulate Digital Signal                   | N/A               | N/A       | 3,4,5     |

### 6.3 Verifying configuration with LOI

The optional LOI can be used for commissioning the device. The LOI is a two-button design with internal and external buttons. The internal buttons are located on the display of the transmitter, while the external buttons are



located underneath the top metal tag. To activate the LOI, push any button. LOI button functionality is shown on the bottom corners of the display. See [Table 6-3](#) and [Figure 6-4](#) for button operation and menu information.

**Figure 6-3: Internal and External LOI Buttons**

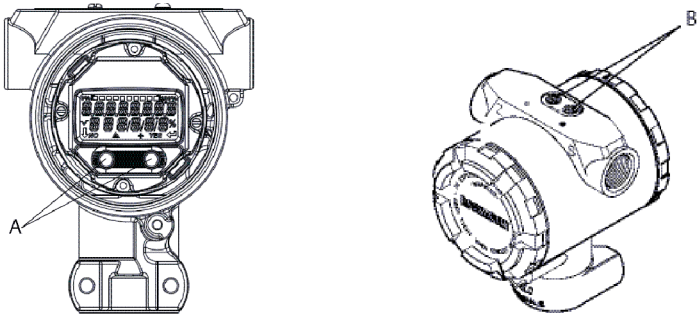

- A. Internal buttons
- B. External buttons

**Note**

See [Figure 7-1](#) to confirm external button functionality.

**Table 6-3: LOI Button Operation**

| Button | EXIT MENU? NO YES | EXIT MENU ↓ ↵ |
|--------|-------------------|---------------|
| Left   | No                | SCROLL        |
| Right  | Yes               | ENTER         |

**Figure 6-4: LOI Menu**

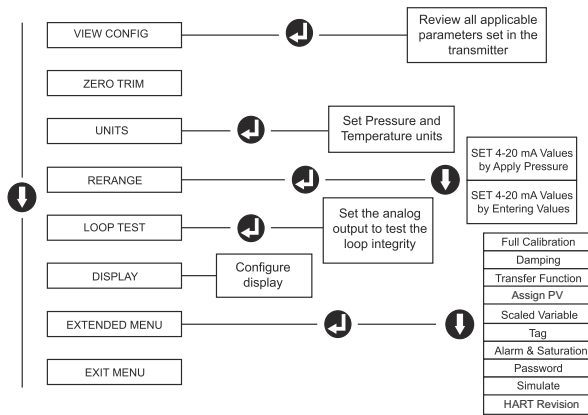

### 6.3.1 Switch HART revision mode

If the HART configuration tool is not capable of communicating with HART® Revision 7, the Rosemount™ 2051G will load a *Generic Menu* with limited capability. The following procedures will switch the HART revision mode from the *Generic Menu*:

**Procedure**

**Manual Setup → Device Information → Identification → Message**

- a) To change to HART Revision 5, Enter: **“HART5”** in the Message field.
- b) To change to HART Revision 7, Enter: **“HART7”** in the Message field.

## 7 Trim the transmitter

Devices are calibrated by the factory. Once installed, it is recommended to perform a zero trim on gage and absolute transmitters to eliminate error due to mounting position or static pressure effects. A zero trim can be performed using either a Field Communicator or configuration buttons.

For instructions using AMS Device Manager, see the Rosemount™ 2051 [Reference Manual](#).

### Note

When performing a zero trim, ensure the equalization valve is open and all wet legs are filled to the correct level.

### ⚠ CAUTION

It is not recommended to zero an absolute transmitter

### Procedure

Select trim procedure.

- a) Analog Zero Trim – Sets the analog output to 4 mA.
  - Also referred to as a “rerange,” it sets the Lower Range Value (LRV) equal to the measured pressure.
  - The display and digital HART output remains unchanged.
- b) Digital Zero Trim – Recalibrates the sensor zero.
  - The LRV is unaffected. The pressure value will be zero (on display and HART output). 4 mA point may not be at zero.
  - This requires that the factory calibrated zero pressure is within a range of three percent of the URV [ $0 \pm 3\% \times \text{URV}$ ].

### 7.1 Example

URV = 150 psi

Applied Zero Pressure =  $+ 0.03 \times 150 \text{ psi} = + 4.5 \text{ psi}$  (compared to factory settings) values outside this range will be rejected by the transmitter

### 7.2 Trimming with a Field Communicator

#### Procedure

1. Connect the Field Communicator, see [Connect the wiring and power up](#) for instructions.

- Follow the HART menu to perform the desired zero trim.

**Table 7-1: Zero Trim Fast Keys**

|                   | Analog zero (set 4 mA) | Digital zero |
|-------------------|------------------------|--------------|
| Fast Key Sequence | 3, 4, 2                | 3, 4, 1, 3   |

## 7.3 Trimming with configuration buttons

A zero trim is to be performed using one of the three possible sets of external configuration buttons located under the top tag.

To access the configuration buttons, loosen the screw and slide the tag on the top of the transmitter. Confirm the functionality using [Figure 6-3](#).

**Figure 7-1: External Configuration Buttons**

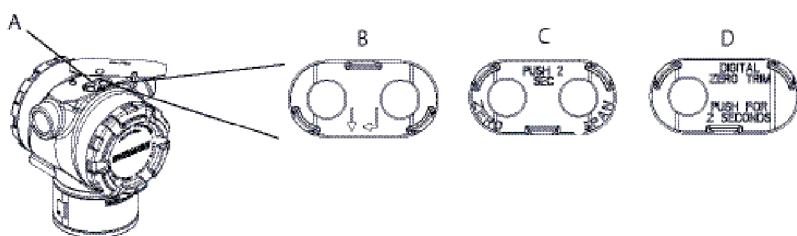

- A. Configuration buttons
- B. LOI
- C. Analog zero and span
- D. Digital zero

Use the following procedures to perform a Zero Trim:

### 7.3.1 Perform trim with LOI (option M4)

#### Procedure

- Set the transmitter pressure.
- See [Figure 6-3](#) for the operating menu.
  - Select **Rerange** to perform an analog zero trim.
  - Select **Zero Trim** to perform a digital zero trim.

### 7.3.2 Perform trim with analog zero and span (option D4)

#### Procedure

- Set the transmitter pressure.

2. Press and hold the **zero** button for two seconds to perform an analog zero trim.

### 7.3.3 Perform trim with digital zero (option DZ)

#### **Procedure**

1. Set the transmitter pressure.
2. Press and hold the **zero** button for two seconds to perform a digital zero trim.

## 8 Safety instrumented systems

For safety certified installations, refer to the [Rosemount™ 2051G Reference Manual](#) for installation procedure and system requirements.

## 9 Product certifications

Rev. 1.5

### 9.1 European Directive Information

A copy of the EU Declaration of Conformity can be found at the end of the Quick Start Guide. The most recent revision of the EU Declaration of Conformity can be found at [Emerson.com/Rosemount](http://Emerson.com/Rosemount).

### 9.2 North America

E5 USA Explosionproof (XP) and Dust-Ignitionproof (DIP)

**Certificate** 1015441

**Standards** FM Class 3600 - 2011, FM, Class 3615 - 2006, FM class 3616 - 2011, FM Class 3810 - 2005

**Markings** XP CL I, DIV 1, GP B, C, D; DIP CL II, DIV 1, GP E, F, G; CL III; T5(-50 °C ≤ T<sub>a</sub> ≤ +85 °C); Factory Sealed; Type 4X

I5 USA Intrinsic Safety (IS) and Nonincendive (NI)

**Certificate** 1015441

**Standards** FM Class 3600 - 2011, FM Class 3610 - 2010, FM Class 3611 - 2004, FM Class 3810 - 2005

**Markings** IS CL I, DIV 1, GP A, B, C, D; CL II, DIV 1, GP E, F, G; Class III; DIV 1 when connected per Rosemount™ drawing 02088-1024; NI CL 1, DIV 2, GP A, B, C, D; T4(-50 °C ≤ T<sub>a</sub> ≤ +70 °C); Type 4x

E6 Canada Explosionproof, Division 2, Dust-Ignitionproof

**Certificate** 1015441

**Standards** CAN/CSA C22.2 No. 0-M91 (R2001), CSA Std C22.2 No. 25-1966, CSA Std C22.2 No. 30-M1986, CAN/CSA-C22.2 No. 94-M91, CSA Std C22.2 No. 142-M1987, CAN/CSA-C22.2 No. 157-92, CSA Std C22.2 No. 213-M1987, ANSI-ISA-12.27.01-2003

**Markings** Class I, Division 1, Groups B, C and D; Class II, Groups E, F, and G; Class III; Class I Division 2 Groups A, B, C and D; Type 4X; Factory Sealed; Single Seal

I6 Canada Intrinsic Safety

**Certificate** 1015441

**Standards** CAN/CSA C22.2 No. 0-M91 (R2001), CSA Std C22.2 No. 25-1966, CSA Std C22.2 No. 30-M1986, CAN/CSA-C22.2 No. 94-M91, CSA Std C22.2 No. 142-M1987, CAN/CSA-C22.2 No. 157-92, CSA Std C22.2 No. 213-M1987, ANSI-ISA-12.27.01-2003

**Markings** Intrinsically Safe Class I, Division 1 when connected in accordance with Rosemount drawing 02088-1024, Temperature Code T4; Ex ia; Type 4X; Factory Sealed; Single Seal

## 9.3 Europe

E1 ATEX Flameproof

**Certificate** KEMA97ATEX2378X

**Standards** EN 60079-0:2012 + A11:2013, EN60079-1:2014, EN60079-26:2015

**Markings** Ⓢ II 1/2 G Ex db IIC T6..T4 Ga/Gb, T6(-60 °C ≤ T<sub>a</sub> ≤ +70 °C), T5/T4 (-60 °C ≤ T<sub>a</sub> ≤ +80 °C)

**Table 9-1: Process Connection Temperature**

| Temperature class | Process connection temperature | Ambient temperature |
|-------------------|--------------------------------|---------------------|
| T6                | -60 to +70 °C                  | -60 to +70 °C       |
| T5                | -60 to +80 °C                  | -60 to +80 °C       |
| T4                | -60 to +120 °C                 | -60 to +80 °C       |

### Special Conditions for Safe Use(X)

1. This device contains a thin wall diaphragm less than 1 mm thickness that forms a boundary between zone 0 (process connection) and zone 1 (all other parts of the equipment). The model code and datasheet are to be consulted for details of the diaphragm material. Installation, maintenance and use shall take into account the environmental conditions to which the diaphragm will be subjected. The manufacturer's instructions for installation and maintenance shall be followed in detail to assure safety during its expected lifetime.
2. Flameproof joints are not intended for repair.
3. Non-standard paint options may cause risk from electrostatic discharge. Avoid installations that could cause electrostatic build-up on painted surfaces, and only clean the painted surfaces with a damp



cloth. If paint is ordered through a special option code, contact the manufacturer for more information.

4. Appropriate cable, glands and plugs need to be suitable for a temperature of 5 °C greater than maximum specified temperature for location where installed.

#### I1 ATEX Intrinsic Safety

|                    |  |
|--------------------|--|
| <b>Certificate</b> | BAS00ATEX1166X   |
| <b>Standards</b>   | EN60079-0:2012 + A11:2013, EN60079-11:2012                   |
| <b>Markings</b>    | Ex II 1 G Ex ia IIC T4 Ga (-55 °C ≤ T <sub>a</sub> ≤ +70 °C) |

**Table 9-2: Input Parameters**

|                            | HART     |
|----------------------------|----------|
| Voltage U <sub>i</sub>     | 30 V     |
| Current I <sub>i</sub>     | 200 mA   |
| Power P <sub>i</sub>       | 0.9 W    |
| Capacitance C <sub>i</sub> | 0.012 μF |

#### Special Conditions for Safe Use(X)

1. The apparatus is not capable of withstanding the 500 V insulation test required by EN60079-11. This must be taken into account when installing the apparatus.
2. The enclosure may be made of aluminum alloy and given a protective polyurethane paint finish; however, care should be taken to protect it from impact or abrasion if located in a Zone 0 environment.

#### N1 ATEX Type n

|                    |  |
|--------------------|--|
| <b>Certificate</b> | BAS00ATEX3167X   |
| <b>Standards</b>   | EN60079-0:2012 + A11:2013, EN60079-15:2010                   |
| <b>Markings</b>    | Ex II 3 G Ex nA IIC T5 Gc (-55 °C ≤ T <sub>a</sub> ≤ +70 °C) |

#### Special Conditions for Safe Use(X)

1. This apparatus is not capable of withstanding the 500V insulation test required by EN60079-15. This must be taken into account when installing the apparatus.

#### ND ATEX Dust

|                    |                |
|--------------------|----------------|
| <b>Certificate</b> | BAS01ATEX1427X |
|--------------------|----------------|

**Standards** EN60079-0:2012 + A11:2013, EN60079-31:2009

**Markings** Ex II 1 D Ex t III C T50 °C T<sub>500</sub> 60 °C Da

### Special Conditions for Safe Use(X)

1. Cable entries must be used which maintain the ingress protection of the enclosure to at least IP66.
2. Unused cable entries must be filled with suitable blanking plugs which maintain the ingress protection of the enclosure to at least IP66.
3. Cable entries and blanking plugs must be suitable for the ambient range of the apparatus and capable of withstanding a 7J impact test.

## 9.4 International

E7 IECEx Flameproof

**Certificate** IECEx KEM 06.0021X

**Standards** IEC 60079-0:2011, IEC 60079-1:2014, IEC 60079-26:2014

**Markings** Ex db IIC T6...T4 Ga/Gb T6(-60 °C ≤ T<sub>a</sub> ≤ +70 °C), T5/T4(-60 °C ≤ T<sub>a</sub> ≤ +80 °C)

**Table 9-3: Process Connection Temperature**

| Temperature class | Process connection temperature | Ambient temperature |
|-------------------|--------------------------------|---------------------|
| T6                | -60 to +70 °C                  | -60 to +70 °C       |
| T5                | -60 to +80 °C                  | -60 to +80 °C       |
| T4                | -60 to +120 °C                 | -60 to +80 °C       |

### Special Conditions for Safe Use(X)

1. This device contains a thin wall diaphragm less than 1 mm thickness that forms a boundary between zone 0 (process connection) and zone 1 (all other parts of the equipment). The model code and datasheet are to be consulted for details of the diaphragm material. Installation, maintenance and use shall take into account the environmental conditions to which the diaphragm will be subjected. The manufacturer's instructions for installation and maintenance shall be followed in detail to assure safety during its expected lifetime.
2. Flameproof joints are not intended for repair.

3. Non-standard paint options may cause risk from electrostatic discharge. Avoid installations that could cause electrostatic build-up on painted surfaces, and only clean the painted surfaces with a damp cloth. If paint is ordered through a special option code, contact the manufacturer for more information.
4. Appropriate cable, glands, and plugs need to be suitable for a temperature of 5 °C greater than maximum specified temperature for location where installed.

#### I7 IECEx Intrinsic Safety

|                    |  |
|--------------------|--|
| <b>Certificate</b> | IECEX BAS 12.0071X                                 |
| <b>Standards</b>   | IEC60079-0:2011, IEC60079-11:2011                  |
| <b>Markings</b>    | Ex ia IIC T4 Ga (-55 °C ≤ T <sub>a</sub> ≤ +70 °C) |

**Table 9-4: Input Parameters**

|                            |          |
|----------------------------|----------|
| Voltage U <sub>i</sub>     | 30 V     |
| Current I <sub>i</sub>     | 200 mA   |
| Power P <sub>i</sub>       | 0.9 W    |
| Capacitance C <sub>i</sub> | 0.012 μF |

#### Special Conditions for Safe Use(X)

1. When fitted with a transient suppression terminal block, the Rosemount™ 2088 is incapable of passing the 500 V isolation test. This must be taken into account during installation.
2. The enclosure may be made of aluminum alloy and given a protective polyurethane paint finish; however, care should be taken to protect it from impact or abrasion if located in a Zone 0 environment.

#### N7 IECEx Type n

|                    |  |
|--------------------|--|
| <b>Certificate</b> | IECEX BAS 12.0072X                                 |
| <b>Standards</b>   | IEC60079-0:2011, IEC60079-15:2010                  |
| <b>Markings</b>    | Ex nA IIC T5 Gc (-40 °C ≤ T <sub>a</sub> ≤ +70 °C) |

#### Special Conditions for Safe Use(X)

1. When fitted with a transient suppression terminal block, the Rosemount 2088 is incapable of passing the 500 V isolation test. This must be taken into account during installation.

#### NK IECEx Dust

|                    |  |
|--------------------|--|
| <b>Certificate</b> | IECEX BAS12.0073X                          |
| <b>Standards</b>   | IEC60079-0:2011, IEC60079-31:2008          |
| <b>Markings</b>    | Ex t IIIC T50 °C T <sub>500</sub> 60 °C Da |

**Table 9-5: Input Parameters**

|                        | HART  |
|------------------------|-------|
| Voltage U <sub>i</sub> | 36 V  |
| Current I <sub>i</sub> | 24 mA |

**Special Conditions for Safe Use(X)**

1. Cable entries must be used which maintain the ingress protection of the enclosure to at least IP66.
2. Unused cable entries must be filled with suitable blanking plugs which maintain the ingress protection of the enclosure to at least IP66.
3. Cable entries and blanking plugs must be suitable for the ambient temperature range of the apparatus and capable of withstanding a 7J impact test.

## 9.5 Brazil

E2 INMETRO Flameproof

**Certificate** UL-BR 15.0728X**Standards** ABNT NBR IEC 60079-0:2013, ABNT NBR IEC 60079-1:2016, ABNT NBR IEC 60079-26:2016**Markings** Ex db IIC T6...T4 Ga/Gb T4/T5(-60 °C ≤ T<sub>a</sub> ≤ +80 °C), T6(-60 °C ≤ T<sub>a</sub> ≤ +70 °C)**Special Conditions for Safe Use(X)**

1. This device contains a thin wall diaphragm less than 1 mm thickness that forms a boundary between zone 0 (process connection) and zone 1 (all other parts of the equipment). The model code and datasheet are to be consulted for details of the diaphragm material. Installation, maintenance, and use shall take into account the environmental conditions to which the diaphragm will be subjected. The manufacturer's instructions for installation and maintenance shall be followed in detail to assure safety during its expected lifetime.
2. Flameproof joints are not intended for repair.

3. Non-standard paint options may cause risk from electrostatic discharge. Avoid installations that could cause electrostatic build-up on painted surfaces, and only clean the painted surfaces with a damp cloth. If paint is ordered through a special option code, contact the manufacturer for more information.

I2 INMETRO Intrinsic Safety

**Certificate** UL-BR 13.0246X

**Standards** ABNT NBR IEC60079-0:2008 + Errata 1:2011, ABNT NBR IEC60079-11:2009

**Markings** Ex ia IIC T4 Ga (-55 °C ≤ T<sub>a</sub> ≤ +70 °C)

**Table 9-6: Input Parameters**

|                            |          |
|----------------------------|----------|
| Voltage U <sub>i</sub>     | 30 V     |
| Current I <sub>i</sub>     | 200 mA   |
| Power P <sub>i</sub>       | 0.9 W    |
| Capacitance C <sub>i</sub> | 0.012 μF |
| Inductance L <sub>i</sub>  | 0 mH     |

**Special Conditions for Safe Use(X)**

1. When fitted with a transient suppression terminal block, the Rosemount™ 2088 is incapable of passing the 500 V isolation test. This must be taken into account during installation.
2. The enclosure may be made of aluminum alloy and given a protective polyurethane paint finish; however, care should be taken to protect it from impact or abrasion if located in a zone 0 environment (areas that require EPL Ga).

## 9.6 China

E3 China Flameproof

**Certificate** GYJ17.1158X

**Standards** GB3836.1-2010, GB3836.2-2010, GB3836.20-2010

**Markings** Ex d IIC T6 ~ T4 Ga/Gb, T5/T4(-60 °C ≤ T<sub>a</sub> ≤ +80 °C), T6(-60 °C ≤ T<sub>a</sub> ≤ +70 °C)

**Special Conditions for Safe Use(X)**

1. Contact the original manufacturer when repair work relates to the flamepath.

## I3 China Intrinsic Safety

**Certificate** GYJ17.1157X**Standards** GB3836.1-2010, GB3836.4-2010, GB3836.20-2010**Markings** Ex ia IIC T4 Ga ( $-55^{\circ}\text{C} \leq T_a \leq +70^{\circ}\text{C}$ )**Special Conditions for Safe Use(X)**

1. The enclosure may contain light metal, attention should be taken to avoid ignition hazard due to impact or friction when used in Zone 0.
2. When transient protection board is chosen (option code T1), this apparatus is not capable of withstanding the 500 V r.m.s insulation test required by Clause 6.3.12 of GB3836.4-2010.

## N3 China Type n

**Certificate** GYJ17.1159X**Standards** GB3836.1-2010, GB3836.8-2014**Markings** Ex nA IIC T5 Gc ( $-40^{\circ}\text{C} \leq T_a \leq +70^{\circ}\text{C}$ )**Special Conditions for Safe Use(X)**

1. When transient protection board is chosen (option code T1), this apparatus is not capable of withstanding the 500 V r.m.s insulation test required by Clause 6.3.12 of GB3836.4-2010.

## 9.7 Technical Regulations Customs Union (EAC)

## EM EAC Flameproof

**Certificate** TC RU C-US.AA87.B.00534**Markings** Ga/Gb Ex db IIC T5/T6 X, T5 ( $-60^{\circ}\text{C} \leq T_a \leq +80^{\circ}\text{C}$ ), T6 ( $-60^{\circ}\text{C} \leq T_a \leq +70^{\circ}\text{C}$ )**Special Conditions for Safe Use(X)**

1. See certificate for special conditions.

## IM EAC Intrinsic Safety

**Certificate** TC RU C-US.AA87.B.00534**Markings** 0Ex ia IIC T4 Ga X, T4 ( $-55^{\circ}\text{C} \leq T_a \leq +70^{\circ}\text{C}$ )**Special Conditions for Safe Use(X)**

1. See certificate for special conditions.

## 9.8 Combinations

- K1** combination of E1, I1, and N1
- K2** combination of E2 and I2
- K3** combination of E3 and I3
- K5** combination of E5 and I5
- K6** combination of E6 and I6
- K7** combination of E7, I7, N7, and NK
- KB** combination of K5 and K6
- KD** combination of E1, I1, K5, and K6
- KM** combination of EM and IM

## 9.9 Conduit plugs and adapters

IECEx Flameproof and Increased Safety

**Certificate** IECEx FMG 13.0032X

**Standards** IEC60079-0:2011, IEC60079-1:2007, IEC60079-7:2006-2007

**Markings** Ex d e IIC Gb

ATEX Flameproof and Increased Safety

**Certificate** FM13ATEX0076X

**Standards** EN60079-0:2012, EN60079-1:2007, IEC60079-7:2007

**Markings** Ex II 2 G Ex d e IIC Gb

**Table 9-7: Conduit Plug Thread Sizes**

| Thread    | Identification mark |
|-----------|---------------------|
| M20 x 1.5 | M20                 |
| ½–14 NPT  | ½ NPT               |
| G ½       | G ½                 |

**Table 9-8: Thread Adapter Thread Sizes**

| Male thread  | Identification mark |
|--------------|---------------------|
| M20 x 1.5–6H | M20                 |
| ½–14 NPT     | ½–14 NPT            |
| ¾–14 NPT     | ¾–14 NPT            |

**Table 9-8: Thread Adapter Thread Sizes (continued)**



| Female thread | Identification mark |
|---------------|---------------------|
| M20 x 1.5-6H  | M20                 |
| ½-14 NPT      | ½-14 NPT            |
| G ½           | G ½                 |



**Special Conditions for Safe Use(X)**



1. When the thread adapter or blanking plug is used with an enclosure in type of protection increased safety “e” the entry thread shall be suitably sealed in order to maintain the ingress protection rating (IP) of the enclosure.
2. The blanking plug shall not be used with an adapter.
3. Blanking Plug and Threaded Adapter shall be either NPT or Metric thread forms. G 1/2 thread forms are only acceptable for existing (legacy) equipment installations.

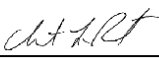

Figure 9-1: Rosemount™ 2051G Declaration of Conformity

|  |   |
|--|---|
|   |  |
| <b>EU Declaration of Conformity</b><br>No: RMD 1010 Rev. N   |   |
| <p>We,</p> <p><b>Rosemount, Inc.</b><br/>8200 Market Boulevard<br/>Chanhassen, MN 55317-9685<br/>USA</p> <p>declare under our sole responsibility that the product,</p> <p><b>Rosemount Pressure Transmitters 3051P, 2051G, 2088, and 2090</b></p> <p>manufactured by,</p> <p><b>Rosemount, Inc.</b><br/>8200 Market Boulevard<br/>Chanhassen, MN 55317-9685<br/>USA</p> <p>to which this declaration relates, is in conformity with the provisions of the European Union Directives, including the latest amendments, as shown in the attached schedule.</p> <p>Assumption of conformity is based on the application of the harmonized standards and, when applicable or required, a European Union notified body certification, as shown in the attached schedule.</p> |   |
| <br>_____<br>(signature)   | Vice President of Global Quality<br>_____<br>(function)                           |
| Chris LaPoint<br>_____<br>(name)   | 1-Feb-19; Shakopee, MN USA (date of issue)  |
| Page 1 of 3  |   |

|   |   |
|---|---|
|    |  |
| <p><b>EU Declaration of Conformity</b><br/> <b>No: RMD 1010 Rev. N</b></p>  |   |
| <p><b>EMC Directive (2014/30/EU)</b></p>  |   |
| <p>Harmonized Standards: EN 61326-1:2013, EN 61326-2-3:2013</p>   |   |
| <p><b>RoHS Directive (2011/65/EU)</b><br/> <b>Model 2090F Pressure Transmitter</b></p>  |   |
| <p>Harmonized Standard: EN 50581:2012</p>   |   |
| <p><b>ATEX Directive (2014/34/EU)</b></p>   |   |
| <p><b>BAS00ATEX1166X - Intrinsic Safety Certificate</b></p>   |   |
| <p>Equipment Group II Category 1 G</p>  |   |
| <p>Ex ia IIC T4 Ga</p>  |   |
| <p>Harmonized Standards:</p>  |   |
| <p>EN60079-0:2012 + A11:2013, EN60079-11:2012</p>   |   |
| <p><b>BAS00ATEX3167X - Type n Certificate</b></p>   |   |
| <p>Equipment Group II Category 3 G</p>  |   |
| <p>Ex nA IIC T5 Gc</p>  |   |
| <p>Harmonized Standards:</p>  |   |
| <p>EN60079-0:2012 + A11:2013, EN60079-15:2010</p>   |   |
| <p><b>BAS01ATEX1427X - Dust Certificate</b></p>   |   |
| <p>Equipment Group II Category 1 D</p>  |   |
| <p>Ex t IIC T50°C T<sub>300</sub>60°C Da</p>  |   |
| <p>Harmonized Standards:</p>  |   |
| <p>EN60079-0:2012 + A11:2013</p>  |   |
| <p>Other Standards:</p>   |   |
| <p>EN60079-31:2009</p>  |   |
| <p>(A review against EN60079-31:2014 which is harmonized, shows no significant changes relevant to this equipment so EN60079-31:2009 continues to represent "State of the Art")</p> |   |
| <p><b>KEMA97ATEX2378X - Flameproof Certificate</b></p>  |   |
| <p>Equipment Group II Category 1/2 G</p>  |   |
| <p>Ex db IIC T6...T4 Gc/Gb</p>  |   |
| <p>Harmonized Standards:</p>  |   |
| <p>EN 60079-0:2012 + A11:2013; EN60079-1:2014; EN60079-26:2015</p>  |   |
| <p>Page 2 of 3</p>  |   |



## EU Declaration of Conformity

No: RMD 1010 Rev. N

---

**ATEX Notified Bodies**

**DEKRA (KEMA)** [Notified Body Number: 0344]  
Utrechtseweg 310, 6812 AR Arnhem  
P.O. Box 5185, 6802 ED Arnhem  
The Netherlands  
Postbank 6794687

**SGS FIMCO OY** [Notified Body Number: 0598]  
P.O. Box 30 (Särkiniementie 3)  
00211 HELSINKI  
Finland

**ATEX Notified Body for Quality Assurance**

**SGS FIMCO OY** [Notified Body Number: 0598]  
P.O. Box 30 (Särkiniementie 3)  
00211 HELSINKI  
Finland

Page 3 of 3

含有China RoHS管控物质超过最大浓度限值的部件型号列表 Rosemount 3051  
List of Rosemount 3051 Parts with China RoHS Concentration above MCVs

| 部件名称<br>Part Name               | 有害物质 / Hazardous Substances |                      |                      |  |  |  |
|---------------------------------|-----------------------------|----------------------|----------------------|--|--|--|
|                                 | 铅<br>Lead<br>(Pb)           | 汞<br>Mercury<br>(Hg) | 镉<br>Cadmium<br>(Cd) | 六价铬<br>Hexavalent<br>Chromium<br>(Cr +6) | 多溴联苯<br>Polybrominated<br>biphenyls<br>(PBB) | 多溴联苯醚<br>Polybrominated<br>diphenyl ethers<br>(PBDE) |
| 电子组件<br>Electronics<br>Assembly | X                           | O                    | O                    | O  | O  | O  |
| 壳体组件<br>Housing<br>Assembly     | X                           | O                    | O                    | X  | O  | O  |
| 传感器组件<br>Sensor<br>Assembly     | X                           | O                    | O                    | X  | O  | O  |

本表格系依据SJ/T11364的规定而制作。

This table is proposed in accordance with the provision of SJ/T11364.

O: 意为该部件的所有均质材料中该有害物质的含量均低于GB/T 26572所规定的限量要求。

O: Indicate that said hazardous substance in all of the homogeneous materials for this part is below the limit requirement of GB/T 26572.

X: 意为在该部件所使用的的所有均质材料里, 至少有一类均质材料中该有害物质的含量高于GB/T 26572所规定的限量要求。

X: Indicate that said hazardous substance contained in at least one of the homogeneous materials used for this part is above the limit requirement of GB/T 26572.









### **Global Headquarters**

Emerson Automation Solutions  
6021 Innovation Blvd.  
Shakopee, MN 55379, USA

- +1 800 999 9307 or +1 952 906 8888
- +1 952 949 7001
- RFQ.RMD-RCC@Emerson.com

### **North America Regional Office**

Emerson Automation Solutions  
8200 Market Blvd.  
Chanhassen, MN 55317, USA

- +1 800 999 9307 or +1 952 906 8888
- +1 952 949 7001
- RMT-NA.RCCRF@Emerson.com

### **Latin America Regional Office**

Emerson Automation Solutions  
1300 Concord Terrace, Suite 400  
Sunrise, FL 33323, USA

- +1 954 846 5030
- +1 954 846 5121
- RFQ.RMD-RCC@Emerson.com

### **Europe Regional Office**

Emerson Automation Solutions Europe  
GmbH  
Neuhofstrasse 19a P.O. Box 1046  
CH 6340 Baar  
Switzerland

- +41 (0) 41 768 6111
- +41 (0) 41 768 6300
- RFQ.RMD-RCC@Emerson.com

### **Asia Pacific Regional Office**

Emerson Automation Solutions  
1 Pandan Crescent  
Singapore 128461

- +65 6777 8211
- +65 6777 0947
- Enquiries@AP.Emerson.com

### **Middle East and Africa Regional Office**

Emerson Automation Solutions  
Emerson FZE P.O. Box 17033  
Jebel Ali Free Zone - South 2  
Dubai, United Arab Emirates

- +971 4 8118100
- +971 4 8865465
- RFQ.RMTMEA@Emerson.com

 [Linkedin.com/company/Emerson-Automation-Solutions](https://www.linkedin.com/company/Emerson-Automation-Solutions)

 [Twitter.com/Rosemount\\_News](https://twitter.com/Rosemount_News)

 [Facebook.com/Rosemount](https://www.facebook.com/Rosemount)

 [Youtube.com/user/RosemountMeasurement](https://www.youtube.com/user/RosemountMeasurement)

©2019 Emerson. All rights reserved.

Emerson Terms and Conditions of Sale are available upon request. The Emerson logo is a trademark and service mark of Emerson Electric Co. Rosemount is mark of one of the Emerson family of companies. All other marks are the property of their respective owners.