

# SmartPower™ Solutions



WirelessHART



## Safety Messages

### NOTICE

This guide provides basic guidelines for the SmartPower family of products. It does not provide instructions for detailed configuration, diagnostics, maintenance, service, troubleshooting, or installation of wireless devices. Refer to the wireless device's manuals and Quick Start Guides (QSG) for more instruction. This guide is also available electronically on [Emerson.com/Rosemount](https://www.emerson.com/Rosemount).

### ⚠ WARNING

#### Explosions could result in death or serious injury.

Installation of this power module in an explosive environment must be in accordance with the appropriate local, national, and international standards, codes, and practices. Review the Product Certifications section for any restrictions associated with a safe installation.

- Before connecting a handheld communicator in an explosive atmosphere, ensure that the instruments are installed in accordance with intrinsically safe or non-incendive field wiring practices.

#### Electrical shock could cause death or serious injury.

- Avoid contact with the leads and terminals. High voltage that may be present on leads can cause electrical shock.
- The power module may be replaced in a hazardous area. The power module has surface resistivity greater than one gigohm and must be properly installed in the wireless device enclosure. Care must be taken during transportation to and from the point of installation to prevent electrostatic charge build-up.

### ⚠ CAUTION

Each Black Power Module contains two "C" size primary lithium-thionyl chloride battery and each Green Power Module contains one "D" size primary lithium battery. Primary lithium batteries are regulated in transportation by the U. S. Department of Transportation, and are also covered by IATA (International Air Transport Association), ICAO (International Civil Aviation Organization), and ARD (European Ground Transportation of Dangerous Goods). It is the responsibility of the shipper to ensure compliance with these or any other local requirements. Consult current regulations and requirements before shipping.

#### Safety Data Sheet (SDS) Location

1. To find the safety data sheet, do one of the following:
  - Scan QR code



- Select this link <https://www.emerson.com/en-us/catalog/emerson-sku-701p-green-smartpower-module>
2. On the Smart Power module product page open **documents and drawings** → **data sheets and bulletins**

**Contents**

Warning on product labels..... 5

Physical installation..... 6

Verify operation.....8

Disposal/recycling of depleted power modules.....11

Product Certifications..... 12



# 1 Warning on product labels

The Rosemount 701P power modules each have a warning printed on them. In each case the warning text is the same. Below is a figure that shows each label.

The text of the warning is: "WARNING Potential Static Hazard, Use Caution when Handling. Risk of Fire, Explosion or Severe Burn Hazard. DO NOT Recharge, Disassemble, Heat above 100 °C, Incinerate or Expose Contents to Water. Li metal content approx 5g."

Figure 1-1: Warning Label on 701PBK

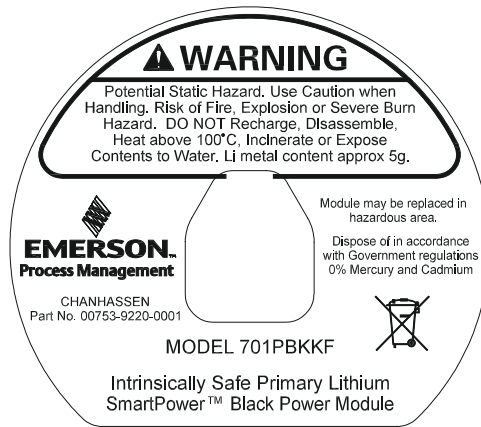
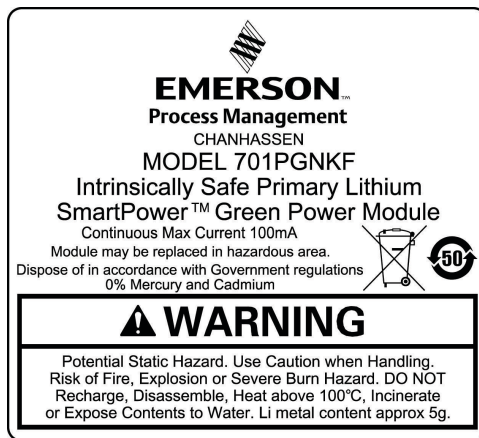

Figure 1-2: Warning Label on 701PGN



## 2 Physical installation

There are two types of power modules that will be discussed in this document. They are the black power module (701PBK) and the green power module (701PGN).

### 2.1 Installing Black power module (701PBK)

#### Prerequisites

Install the HART® device according to standard installation practices and the manufacturer's instructions, being sure to use an approved thread sealant on all connections.

#### Procedure

1. Unscrew the power module cover from the wireless device.
2. Connect the power module to the wireless device. The power module has a keyed connection to prevent improper connection.

---

#### Note

Wireless devices should be powered up in order of proximity from the Smart Wireless Gateway, beginning with the closest device to the Gateway. This will result in a simpler and faster network installation.

---

3. Connect the power module to the wireless device. The power module has a keyed connection to prevent improper connection.
- 

**Figure 2-1: Black Power Module Installation**

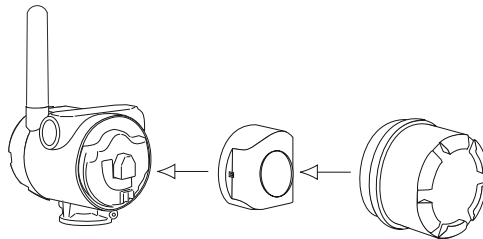

## 2.2 Installing Green power module (701PGN)

### Prerequisites

Install the HART device according to standard installation practices and the manufacturer's instructions, being sure to use an approved thread sealant on all connections.

### Procedure

1. Unscrew the power module cover from the wireless device.
2. Connect the green power module to the wireless device. The green power module has a keyed connection to prevent improper connection. If the Green power module is placed into the housing the wrong way, it will not fit entirely into the housing.

---

### Note

Wireless devices should be powered up in order of proximity from the Smart Wireless Gateway, beginning with the closest device to the Gateway. This will result in a simpler and faster network installation.

---

3. Close the housing cover and tighten. Ensure the power module cover is fully tightened to prevent moisture ingress. The lip of the polymer power module cover should be in contact with the surface of the polymer enclosure to ensure a proper seal. Do not over tighten.
- 

**Figure 2-2: Green Power Module Installation**

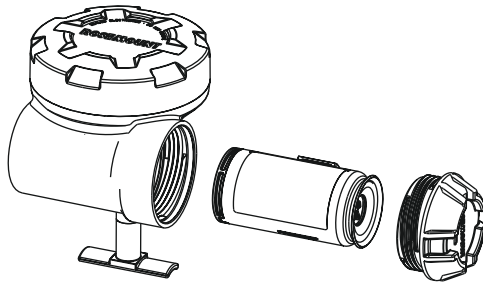

## 3 Verify operation

Operation can be verified in four locations: by using the Field Communicator, at the Gateway via the Wireless Gateway's integrated web server, via AMS Wireless Configurator, or with the wireless device's LCD display.

### 3.1 Verify operation using Field Communicator

If you are able to communicate to the wireless device via a Field Communicator, the power module is powering the device and working correctly. [Figure 3-1](#) shows how to connect a Field Communicator to a wireless device with either the black or green power module.

**Figure 3-1: Connect to Device**

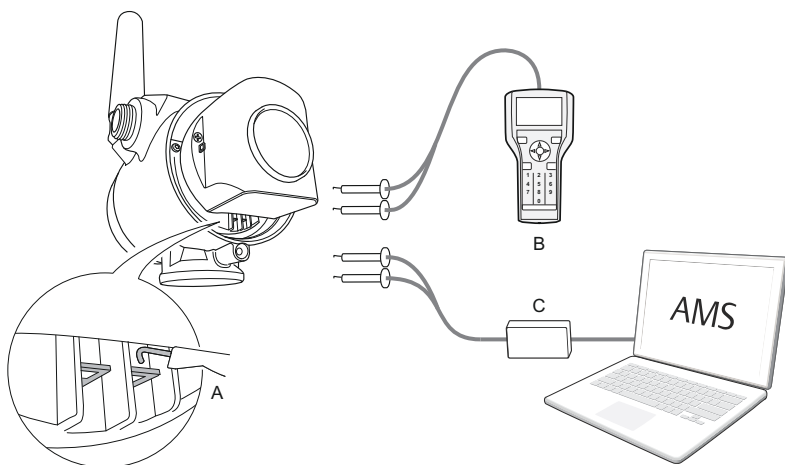

- A. Communication terminals
- B. Handheld communicator
- C. HART modem

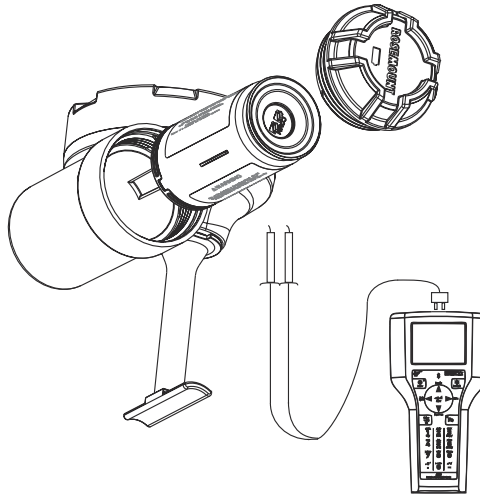

---

**Figure 3-2: Field Communicator**

---

### 3.2 Verify operation using Emerson Wireless Gateway

If the wireless device was configured with the Network ID and Join Key, and sufficient time has passed for network polling, the transmitter will be connected to the network. To verify device operation and connection to the network with the Smart Wireless Gateway's integrated web server, open the Smart Wireless Gateway's integral web interface and navigate to the Explorer page. If the wireless device has joined the network, the power module is functioning properly.

---

**Note**

It may take several minutes for the device to join the network.

---

### 3.3 Verify operation using AMS Device Manager

When the device has joined the network, it will appear in the AMS Device Manager as illustrated in [Figure 3-3](#).

Figure 3-3: AMS Device Manger

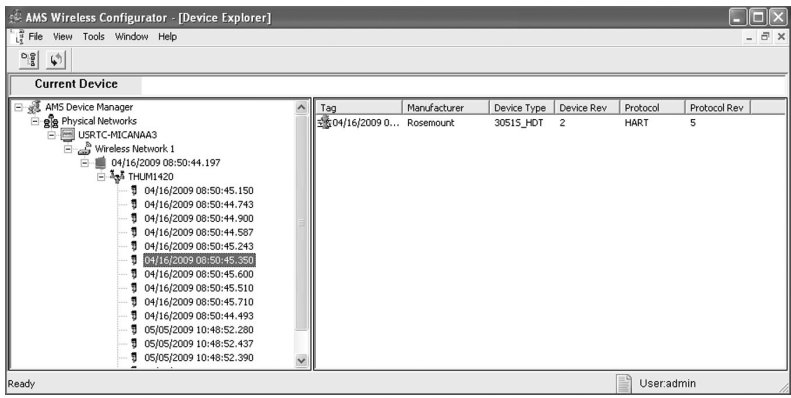

### 3.4 Verify operation using wireless device LCD Display

If the wireless device that you are connecting the power module to has an LCD display, it can be used to verify operation. When the power module is first connected to the wireless device, the LCD display will turn on for approximately 40 seconds. If the LCD display turns on after the power module is installed, the power module is functioning properly.

### 3.5 Troubleshooting

If the wireless device does not turn on after the power module is installed, the power module may be depleted. Replace the power module and see if the wireless device turns on. If not, refer to the troubleshooting section of the wireless device's manual.

## 4 Disposal/recycling of depleted power modules

1. Dispose in accordance with applicable laws and regulations in your country and state.
2. Disposal should only be performed by authorized professionals in accordance with applicable requirements for hazardous waste transportation and disposal.
3. Incineration should only be performed by trained professionals in authorized facilities.

### Shipping regulations

Primary lithium batteries are regulated in transportation by the U.S. Department of Transportation, and are also covered by IATA (International Air Transport Association), ICAO (International Civil Aviation Organization), and ARD (European Ground Transportation of Dangerous Goods). It is the responsibility of the shipper to ensure compliance with these or any other local requirements. Please consult current regulations and requirements before shipping.

### Handling considerations

Each black power module contains two “C” size primary lithium batteries. Each green power module contains one “D” size primary lithium battery.

Under normal conditions, the battery materials are self-contained and are not reactive as long as the batteries and the battery pack integrity are maintained. Care should be taken to prevent thermal, electrical, or mechanical damage. Contacts should be protected to prevent premature discharge.

Use caution when handling the power module. It may be damaged if dropped onto a hard surface. Battery hazards remain when cells are discharged.

### Environmental considerations

As with any battery, local environmental rules and regulations should be consulted for proper management of spent batteries. If no specific requirements exist, recycling through a qualified recycler is encouraged. Consult the materials safety data sheet for battery specific information.

## 5 Product Certifications

Rev 4.3

### 5.1 Directive information

A copy of the Declaration of Conformity can be found at the end of the Quick Start Guide. The most recent revision of the Declaration of Conformity can be found at [Emerson.com/Rosemount](https://www.emerson.com/Rosemount).

### 5.2 Ordinary location certification

As standard, the transmitter has been examined and tested to determine that the design meets the basic electrical, mechanical, and fire protection requirements by a Nationally Recognized Test Laboratory (NRTL), as accredited by the Federal Occupational Safety and Health Administration (OSHA).

### 5.3 North America

#### 5.4 USA

##### 5.4.1 KF USA Intrinsically Safe (IS)

**Certificate:** 3042016

**Standards:** FM Class 3600 – 1998, FM Class 3610 – 2010, FM Class 3810 – 2005

**Markings:** IS CL I, DIV 1, GP A, B, C, D; CL II, DIV 1, GP E, F, G; Class III; Class 1, Zone 0 AEx ia IIC T4; T4(-40 °C ≤ T<sub>a</sub> ≤ +70 °C)  
(See [Table 5-1](#) or [Table 5-2](#) for parameters)

#### **Special Condition for Safe Use (X):**

Replacement of power module, see instructions for final product.

#### 5.5 Canada

##### 5.5.1 KF Canada Intrinsically Safe

**Certificates:** 2430393

**Standards:** CAN/CSA C22.2 No. 0-M91, CSA Std C22.2 No. 157-92

**Markings** Intrinsically Safe Class I, Division 1, Groups A, B, C, and D T3C(T<sub>a</sub> ≤ +70 °C) Warning – refer to QIG 825-0100-4701 for Safe I.S. Use  
(See [Table 5-1](#) or [Table 5-2](#) for parameters)

**Special Condition for Safe Use (X):**

The power modules are certified as components for use in intrinsically safe products where the suitability/combination of use in the final assembly shall be subjected to CSA acceptance. The final assembly must incorporate all protection features necessary for batteries in accordance with applicable standards of the final intrinsically safe application.

## 5.6 Europe

### 5.6.1 KF ATEX Intrinsic Safety

**Certificate:** Baseefa11ATEX0042X

**Standards:** EN 60079-0: 2018, EN 60079-11: 2012

**Markings**



II 1 G Ex ia IIC T4 Ga, T4(-55 °C ≤ T<sub>a</sub> ≤ +70 °C)



II 1 G Ex ia IIC T5 Ga, T5(-55 °C ≤ T<sub>a</sub> ≤ +40 °C)

(See [Table 5-1](#) or [Table 5-2](#) for parameters)

**Special Condition for Safe Use (X):**

The plastic enclosure of the Model 701P SmartPower Power Modules may constitute a potential electrostatic ignition risk and caution should be used when being handled.

**Note**

This condition of use does not apply after a Power Module is installed within a wireless transmitter enclosure.

## 5.7 International

### 5.7.1 KF IECEx Intrinsic Safety

**Certificate:** IECEx BAS 11.0026X

**Standards:** IEC 60079-0: 2011, IEC 60079-11: 2011

**Markings:** Ex ia IIC T4/T5 Ga, T4(-55 °C ≤ T<sub>a</sub> ≤ +70 °C), T5(-55 °C ≤ T<sub>a</sub> ≤ +40 °C)

**Special Condition for Safe Use (X):**

The plastic enclosure of the Model 701P SmartPower Power Modules may constitute a potential electrostatic ignition risk and caution should be used when being handled.

**Note**

This condition of use does not apply after a Power Module is installed within a wireless transmitter enclosure.

## 5.8 INMETRO - Brazil

### 5.8.1 KF Brazil Intrinsic Safety

**Certificate:** UL-BR 14.0123X

**Standards** ABNT NBR IEC 60079-0:2008 + Errata 1:2011, ABNT NBR IEC 60079-11:2009

**Markings:** Ex ia IIC T4/T5 Ga X  
 T4 ( $-55\text{ °C} \leq T_a \leq +70\text{ °C}$ )  
 T5 ( $-55\text{ °C} \leq T_a \leq +40\text{ °C}$ )

## 5.9 China

### 5.9.1 KF China 本质安全

**证书** GYJ20.1357X (CCC 认证)

**所用标准** GB3836.1 – 2010, GB3836.4 – 2010, GB3836.20-2010

**标志** Ex ia IIC T4/T5 Ga

**特殊使用条件(X):**

电池外壳为非金属材质，可能产生静电危险，只能用湿布擦拭。

**使用注意事项:**

1. 电池外壳为非金属材质，可能产生静电危险，只能用湿布擦拭。使用注意事项：1. 产品使用环境温度为：温度组别产品使用环境温度

| 温度组别 | 产品使用环境温度                                    |
|------|---|
| T4   | $-60\text{ °C} \leq T_a \leq +70\text{ °C}$ |
| T5   | $-60\text{ °C} \leq T_a \leq +40\text{ °C}$ |

2. 本安电气参数:

| 电池类型 | 最高输出电压 $U_o$ (V) | 最大输出电流 $I_o$ (A) | 最大输出功率 $P_o$ (W) | 最大外部等效参数 |        |
|------|------------------|------------------|------------------|----------|--------|
|      |                  |                  |                  | Co(μF)   | Lo(μH) |
| BK   | 7.8              | 2.16             | 0.83             | 3.0      | 9.4    |
| GN   | 3.9              | 2.78             | 2.71             | 100      | 4.6    |

3. 用户不得自行更换该产品的零部件，应会同产品制造商共同解决运行中出现的故障，以杜绝损坏现象的发生。
4. 产品的安装、使用和维护应同时遵守产品使用说明书、GB3836.13-2013“爆炸性环境 第 13 部分：设备的修理、检修、修复和改造”、GB/T3836.15-2017“爆炸性环境 第 15 部分：电气装置的设计、选型和安装”、GB/T3836.16-2017“爆炸性环境 第 16 部分：电气装置的检查与维护”、GB/T 3836.18-2017“爆炸性环境 第 18 部分：本质安全电气系统”、GB50257-2014“电气装置安装工程爆炸和火灾危险环境电力装置施工及验收规范”的有关规定。

See [Table 5-1](#) or [Table 5-2](#) for parameters.

## 5.9.2 Tables

**Table 5-1: 701PBK**

|       |             |
|-------|-------------|
| $U_o$ | 7.8 V       |
| $I_o$ | 2.16 A      |
| $P_o$ | 0.83 W      |
| $C_o$ | 3.0 $\mu$ F |
| $L_o$ | 7.6 $\mu$ H |



**Table 5-2: 701PGN**

|       |             |
|-------|-------------|
| $U_o$ | 3.9 V       |
| $I_o$ | 2.78 A      |
| $P_o$ | 2.71 W      |
| $C_o$ | 100 $\mu$ F |
| $L_o$ | 4.6 $\mu$ H |



## 5.10 Declaration of Conformity

|   |  |   |
|---|--|---|
|    | <b>EU Declaration of Conformity</b>                            |  |
| No: RMD 1085 Rev. E   |  |   |
| We,   |  |   |
| <b>Rosemount, Inc.</b><br>8200 Market Boulevard<br>Chanhassen, MN 55317-9685<br>USA   |  |   |
| declare under our sole responsibility that the product,   |  |   |
| <b>Rosemount 701P SmartPower Power Module</b>   |  |   |
| manufactured by,  |  |   |
| <b>Rosemount, Inc.</b><br>8200 Market Boulevard<br>Chanhassen, MN 55317-9685<br>USA   |  |   |
| to which this declaration relates, is in conformity with the provisions of the European Union Directives, including the latest amendments, as shown in the attached schedule.                       |  |   |
| Assumption of conformity is based on the application of the harmonized standards and, when applicable or required, a European Union notified body certification, as shown in the attached schedule. |  |   |
| <br>_____<br>(signature)   | Vice President of Global Quality<br>_____<br>(function)        |   |
| Mark Lee<br>_____<br>(name)   | 1-Apr-21; Shakopee, MN USA<br>_____<br>(date of issue & place) |   |
| Page 1 of 2   |  |   |

|  |  |   |
|--|--|---|
|   | <b>EU Declaration of Conformity</b><br>No: RMD 1085 Rev. E |  |
| <b>EMC Directive (2014/30/EU)</b>  |  |   |
| Harmonized Standards:<br>EN 61326-1: 2013  |  |   |
| <b>ATEX Directive (2014/34/EU)</b>   |  |   |
| <b>Baseefa11ATEX0042X – Intrinsic Safety Certificate</b>   |  |   |
| Equipment Group II, Category 1 G<br>Ex ia IIC Ga T4/T5<br>Harmonized Standards:<br>EN 60079-0:2012/A11:2013<br>EN 60079-11: 2012 |  |   |
| <b>ATEX Notified Body</b>  |  |   |
| SGS FIMKO OY [Notified Body Number: 0598]<br>Takomitie 8<br>00380 HELSINKI<br>Finland  |  |   |
| <b>ATEX Notified Body for Quality Assurance</b>  |  |   |
| SGS FIMKO OY [Notified Body Number: 0598]<br>Takomitie 8<br>00380 HELSINKI<br>Finland  |  |   |
| Page 2 of 2  |  |   |

## 5.11 China RoHS

含有China RoHS 管控物质超过最大浓度限值的部件型号列表 Rosemount 701P  
List of Rosemount 701P Parts with China RoHS Concentration above MCVs

| Part Name<br>部件名称               | Hazardous Substances / 有害物质 |                      |                      |  |  |  |
|---------------------------------|-----------------------------|----------------------|----------------------|--|--|--|
|                                 | Lead<br>铅<br>(Pb)           | Mercury<br>汞<br>(Hg) | Cadmium<br>镉<br>(Cd) | Hexavalent<br>Chromium<br>六价铬<br>(Cr +6) | Polybrominated<br>biphenyls<br>多溴联苯<br>(PBB) | Polybrominated<br>diphenyl ethers<br>多溴联苯醚<br>(PBDE) |
| 电子组件<br>Electronics<br>Assembly | X                           | O                    | O                    | O  | O  | O  |
| 电池组件<br>Battery<br>Assembly     | X                           | O                    | O                    | O  | O  | O  |

本表格系依据SJ/T11364的规定而制作。

This table is proposed in accordance with the provision of SJ/T11364.

O: 意为该部件的所有均质材料中该有害物质的含量均低于GB/T 26572所规定的限量要求。

O: Indicate that said hazardous substance in all of the homogeneous materials for this part is below the limit requirement of GB/T 26572.

X: 意为在该部件所使用的的所有均质材料里，至少有一类均质材料中该有害物质的含量高于GB/T 26572所规定的限量要求。

X: Indicate that said hazardous substance contained in at least one of the homogeneous materials used for this part is above the limit requirement of GB/T 26572.



**Quick Start Guide**  
**00825-0100-4701, Rev. DF**  
**March 2023**

For more information: [Emerson.com](https://www.emerson.com)

©2023 Emerson. All rights reserved.

Emerson Terms and Conditions of Sale are available upon request. The Emerson logo is a trademark and service mark of Emerson Electric Co. Rosemount is a mark of one of the Emerson family of companies. All other marks are the property of their respective owners.

**ROSEMOUNT™**

