

Rosemount™ 2088, 2090F, and 2090P Pressure Transmitter

with 4–20 mA HART® and 1–5 Vdc Low
Power HART Protocol (Revision 5 and 7)



NOTICE

This guide provides basic guidelines for Rosemount 2088, 2090F, and 2090P Transmitters. It does not provide instructions for configuration, diagnostics, maintenance, service, troubleshooting, Explosion-proof, Flameproof, or intrinsically safe (I.S.) installations. See the Rosemount 2088 Reference Manual for more information. This manual is also available electronically on Emerson.com/Rosemount.

⚠ WARNING

Explosions could result in death or serious injury.

Installation of this transmitter in an explosive environment must be in accordance with the appropriate local, national, and international standards, codes, and practices. Review the approvals section of this manual for any restrictions associated with a safe installation.

- Before connecting a handheld communicator in an explosive atmosphere, make sure the instruments in the loop are installed in accordance with intrinsically safe or non-incendive fieldwiring practices.
- In an explosion-proof/flameproof installation, do not remove the transmitter covers when power is applied to the unit.

Process leaks could result in death or serious injury.

To avoid process leaks, only use the O-ring designed to seal with the corresponding flange adapter.

Electrical shock could cause death or serious injury.

Avoid contact with the leads and terminals. High voltage that may be present on leads can cause electrical shock.

Conduit/cable entries

Unless marked, the conduit/cable entries in the transmitter housing use a 1/2–14 NPT thread form. Entries marked “M20” are M20 x 1.5 thread form. On devices with multiple conduit entries, all entries will have the same thread form. Only use plugs, adapters, glands, or conduit with a compatible thread form when closing these entries.

Contents

System readiness.....	3
Mount the transmitter.....	5
Set the switches.....	9
Connect the wiring and power up.....	11
Verify transmitter configuration using a Field Communicator.....	14
Trim the transmitter.....	20
Safety Instrumented Systems (SIS) installation.....	23
Product certifications.....	24
Rosemount 2088 and 2090 Declaration of Conformity.....	44
China RoHS.....	47

1 System readiness

Confirm HART revision capability

- If using HART-based control or asset management systems, confirm the HART capability of those systems prior to transmitter installation. Not all systems are capable of communicating with HART Revision 7 Protocol. This transmitter can be configured for either HART Revision 5 or 7.
- For instructions on how to change the HART revision of the transmitter, see [Switch HART Revision mode](#).

1.1 Confirm correct device driver

Verify the latest device driver (DD/DTM™) is loaded on your systems to ensure proper communication.

Note

The Rosemount 2088, 2090F, and 2090P Transmitters all use Rosemount 2088 Device Revisions and Drivers.

Procedure

1. Download the latest DD at Emerson.com or FieldCommGroup.org.
2. In the **Browse by Member** dropdown menu, select **Emerson**.
3. Select desired product.
 - a) Reference [Table 1-1](#) and [Table 1-2](#), Find Device Driver Files column to find the correct device driver.

Table 1-1: Rosemount 2088 and 2090 with 4–20 mA HART Device Revisions and Files

Release date	Device identification			Device driver identification		Review instructions	Review functionality
	NAMUR revision ⁽¹⁾		HART revision ⁽²⁾		Device revision ⁽³⁾	Reference manual	Change description ⁽⁴⁾ (5)
	Hardware	Software	Universal				
Aug-16	1.1.xx	1.0.xx	3	7	10	Rosemount 2088, 2090P and 2090F Reference Manual	(5)
				5	9		
Jan-13	N/A	1.0.xx	1	7	10		(4)
				5	9		
Jan-98	N/A	N/A	178	5	3		

(1) NAMUR revision is located on the hardware tag of the device. Differences in level 3 changes, signified above by xx, represent minor product changes as defined per NE53. Compatibility and functionality are preserved and product can be used interchangeably.

- (2) HART software revision can be read using a HART capable configuration tool. Value shown is minimum revision that could correspond to NAMUR revisions.
- (3) Device driver file names use device and DD revision (e.g. 10_01). HART Protocol is designed to enable legacy device driver revisions to continue to communicate with new HART devices. To access new functionality, the new device driver must be downloaded. It is recommended to download new device driver files to ensure full functionality.
- (4) HART Revision 5 and 7 selectable, Local Operator Interface (LOI), scaled variable, configurable alarms, expanded engineering units.
- (5) Updated electronics hardware design. Intrinsic Safety temperature classification change.

Table 1-2: Rosemount 2088 with 1–5 Vdc Low Power HART Device Revisions and Files

Release date	Device identification			Device driver identification		Review instructions	Review functionality
	NAMUR revision ⁽¹⁾		HART revision ⁽²⁾	Universal	Device revision ⁽³⁾	Reference manual	Change description ⁽⁴⁾
	Hardware	Software					
Jan-13	N/A	1.0.2	3	7	10	Rosemount 2088, 2090P and 2090F Reference Manual	⁽⁴⁾
				5	9		
Jan-98	N/A	N/A	178	5	3		N/A

- (1) NAMUR revision is located on the hardware tag of the device. Differences in level 3 changes, signified above by xx, represent minor product changes as defined per NE53. Compatibility and functionality are preserved and product can be used interchangeably.
- (2) HART software revision can be read using a HART capable configuration tool. Value shown is minimum revision that could correspond to NAMUR revisions.
- (3) Device driver file names use device and DD revision (e.g. 10_01). HART Protocol is designed to enable legacy device driver revisions to continue to communicate with new HART devices. To access new functionality, the new device driver must be downloaded. It is recommended to download new device driver files to ensure full functionality.
- (4) HART Revision 5 and 7 selectable, Local Operator Interface (LOI), scaled variable, configurable alarms, expanded engineering units.

2 Mount the transmitter

2.1 Rosemount 2088

Mount directly to the impulse line without using an additional mounting bracket or mount directly to a wall, panel, or 2-in. pipe using an optional mounting bracket.

2.2 Rosemount 2090P

Mount directly to the process pipe using an existing weld spud, or have a skilled welder install a new weld spud using a TIG welder. Refer to [Reference Manual](#) for complete welding instructions. Improper installation may result in weld spud distortion. Recommended mounting in upright or horizontal position to allow proper draining of vent.

2.3 Rosemount 2090F

Mount directly to the process pipe using a standard sanitary fitting (either a 1.5- or 2-in. Tri Clamp connection). Recommended mounting in upright or horizontal position to allow proper draining of vent.

Figure 2-1: Transmitter Direct Mounting

Do not apply torque directly to the electronics housing. To avoid damage, apply torque only to the hex-shaped process connection.

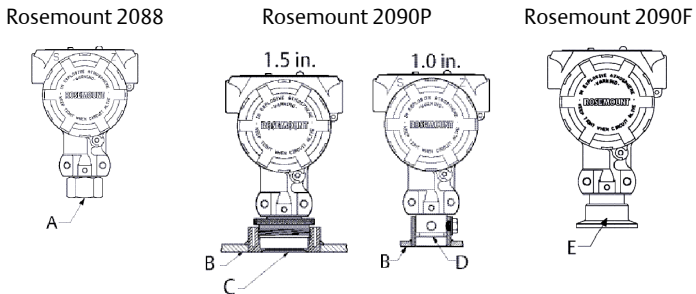

- A. $\frac{1}{2}$ -14 NPT female process connection
- B. Vessel wall
- C. Weld spud
- D. O-ring
- E. $1\frac{1}{2}$ - or 2-in. Tri Clamp connection

Figure 2-2: Panel and Pipe Mounting

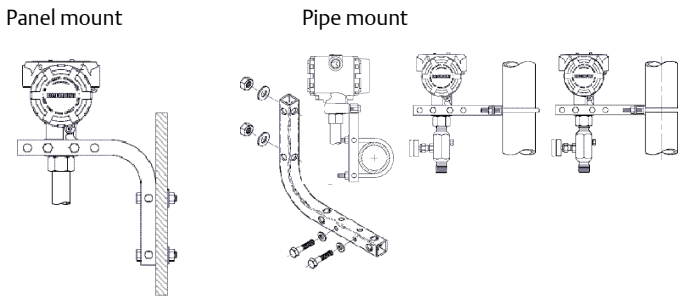

2.4 Liquid flow applications

Transmitter mounting procedure for liquid flow applications.

Procedure

1. Place taps to the side of the line.
2. Mount beside or below the taps.

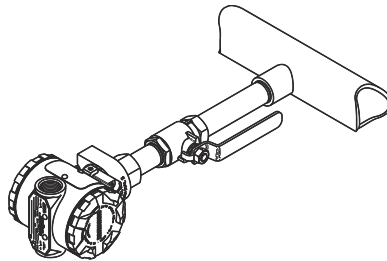

2.5 Gas flow applications

Transmitter mounting procedure for gas flow applications.

Procedure

1. Place taps in the top or side of the line.
2. Mount level or above the taps.

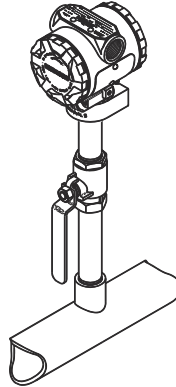

2.6 Steam flow applications

Transmitter mounting procedure for steam flow applications.

Procedure

1. Place taps to the side of the line.
2. Mount beside or below the taps.
3. Fill impulse lines with water.

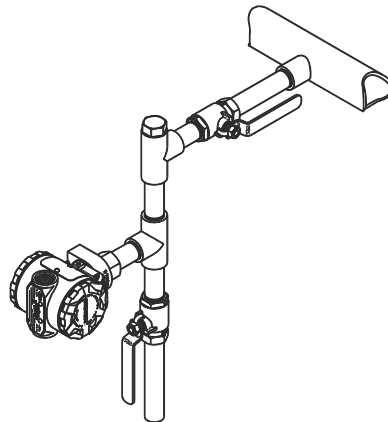

2.7 Environmental seal for housing

Thread sealing (PTFE) tape or paste on male threads of conduit is required to provide a water/dust tight conduit seal and meets requirements of NEMA® Type 4X, IP66, and IP68. Consult factory if other Ingress Protection ratings are required. For M20 threads, install conduit plugs to full thread engagement or until mechanical resistance is met.

2.8 Gage transmitter orientation

The low side pressure port (atmospheric reference) on the gage transmitters with aluminum housings are located in the neck of the transmitter, behind the housing. The vent path is 360° around the transmitter between the housing and sensor. (See [Figure 2-3](#).)

Keep the vent path free of any obstruction, including but not limited to paint, dust, and lubrication by mounting the transmitter so that the process can drain away.

Figure 2-3: Gage Low Side Pressure Port

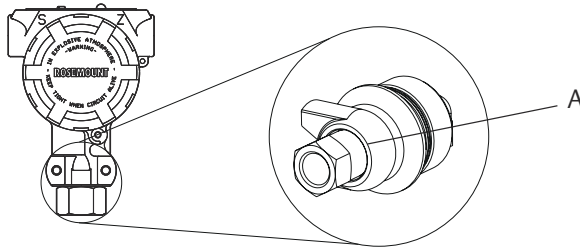

A. Low side pressure port (atmospheric reference)

3 Set the switches

Set alarm and security switch configuration before installation as shown in Figure 3-1.

- The alarm switch sets the analog output alarm to high or low. Default alarm is high.
- The security switch allows (🔓) or prevents (🔒) any configuration of the transmitter. Default security is off (🔓).

Use the following procedure to change the switch configuration:

Procedure

1. If the transmitter is installed, secure the loop, and remove power.
2. Remove the housing cover opposite the field terminal side. Do not remove the instrument cover in explosive atmospheres when the circuit is live.
3. Slide the security and alarm switches into the preferred position using a small screwdriver.
4. Reattach the transmitter cover. The cover must be fully engaged to comply with explosion-proof requirements.

Figure 3-1: Transmitter Electronics Board

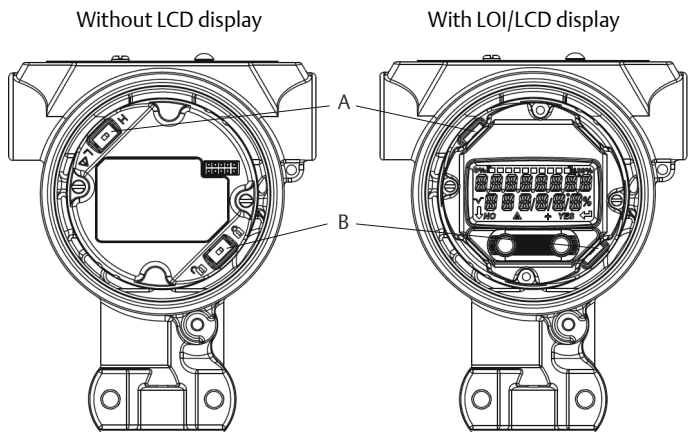

- A. Alarm
B. Security switch

⚠ CAUTION

Do not tamper with or remove the electronics board in the Rosemount 2088, 2090F, or 2090P. This will cause permanent damage to the transmitter.

3.1 Electronics board

The Rosemount 2088 and 2090 electronics board should not be tampered with or removed from the housing as it could cause permanent damage to the transmitter.

3.2 LOI/LCD display

The LOI/LCD display can be removed and rotated as needed by following the “Rotating LOI/LCD display” instructions in the Rosemount 2088 [Reference Manual](#).

4 Connect the wiring and power up

Shielded twisted pair cable should be used for best results. Use 24 AWG or larger wire that does not exceed 5000 ft. (1500 m) in length. If applicable, install wiring with a drip loop. Arrange the drip loop so the bottom is lower than the conduit connections and the transmitter housing.

Figure 4-1: Wiring the Transmitter (4–20 mA HART)

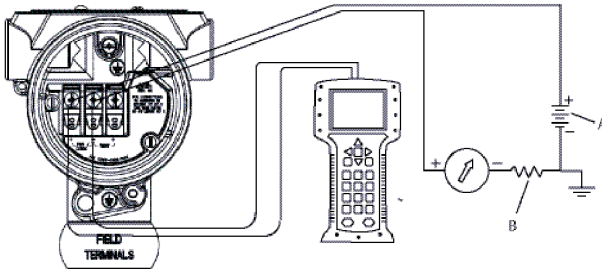

- A. Vdc supply
- B. $R_L \geq 250$ (necessary for HART Communication only)

Figure 4-2: Wiring the Transmitter (1–5 Vdc Low Power)

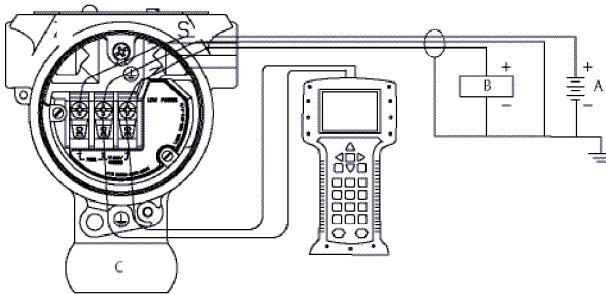

- A. Power supply
- B. Voltmeter
- C. Field terminals

⚠ CAUTION

- Installation of the transient protection terminal block does not provide transient protection unless the transmitter case is properly grounded.
- Do not run signal wiring in conduit or open trays with power wiring, or near heavy electrical equipment. Do not connect the powered signal wiring to the test terminals.
- Power could damage the test diode in the terminal block.

4.1 Wire the transmitter

Use the following steps to wire the transmitter:

Procedure

1. Remove the housing cover on the FIELD TERMINALS side.
2. Connect the leads as shown in [Figure 4-1](#) or [Figure 4-2](#).
3. Tighten the terminal screws to ensure full contact with the terminal block screw and washer. When using a direct wiring method, wrap wire clockwise to ensure it is in place when tightening the terminal block screw.

Note

The use of a pin or ferrule wire terminal is not recommended as the connection may be more susceptible to loosening over time or under vibration.

4. Ground housing to fulfill local grounding regulations.
5. Ensure proper grounding.
It is important that the instrument cable shield:
 - Be trimmed close and insulated from touching the transmitter housing
 - Be connected to the next shield if cable is routed through a junction box
 - Be connected to a good earth ground at the power supply end
6. If transient protection is needed, refer to [Grounding for transient terminal block](#) for grounding instructions.
7. Plug and seal unused conduit connections.
8. Replace the housing cover.

Figure 4-3: Grounding

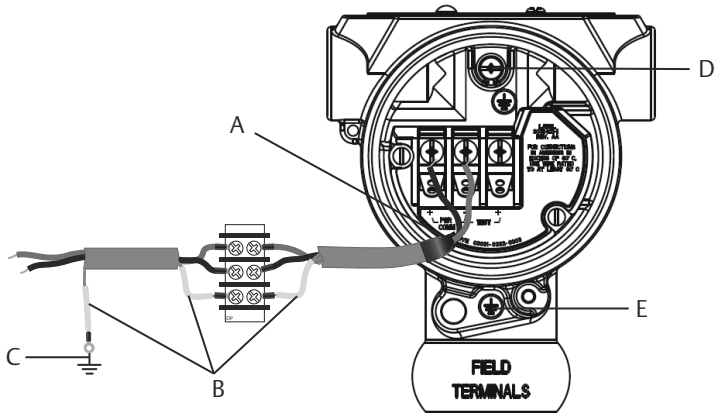

- A. Trim shield and insulate
- B. Insulate shield
- C. Terminate cable shield drain wire to earth ground
- D. Internal ground location
- E. External ground location

4.2 Grounding for transient terminal block

Ground termination is provided on the outside of the electronics housing and inside the terminal compartment. These grounds are used when the transient protection terminal blocks are installed. It is recommended that 18 AWG or larger wire is used to connect housing ground to earth ground (internal or external).

If the transmitter is currently not wired for power up and communication (follow steps in [Connect the wiring and power up](#)). When the transmitter is properly wired, refer to [Figure 4-3](#) for internal and external transient grounding locations.

5 Verify transmitter configuration using a Field Communicator

Verify the configuration using any HART capable configuration tool or LOI - option code M4. Configuration instructions for a Field Communicator and LOI are included in this step. See Rosemount 2088 [Reference Manual](#) for configuration instructions using AMS Device Manager.

A Rosemount 2088 DD must be installed on the Field Communicator to verify configuration. Fast Key sequences vary depending on device and DD revisions. Use the [Determine Fast Key sequence table for the Field Communicator user interface](#) process below to identify the appropriate Fast Key sequences.

5.1 Determine Fast Key sequence table for the Field Communicator user interface

Procedure to determine the Fast Key sequence table for the Field Communicator.

Procedure

1. Connect Field Communicator to Rosemount 2088, 2090F, or 2090P.
2. If **Home** screen matches [Figure 5-1](#), refer to [Table 5-1](#) for Fast Key sequences.

OR

3. If **Home** screen matches [Figure 5-2](#):
 - a) Perform Fast Key sequence 1,7,2 to identify Field Revision and HART Revision.
 - b) Refer to [Table 5-2](#) and the appropriate column based on your Field Revision and HART Revision for Fast Key sequences.

Emerson recommends installing the latest DD to access the complete functionality. Visit Emerson.com or FieldCommGroup.org.

Figure 5-1: Traditional Interface

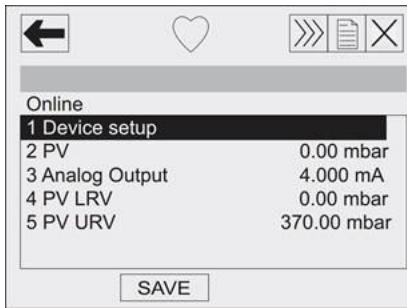

Figure 5-2: Device Dashboard

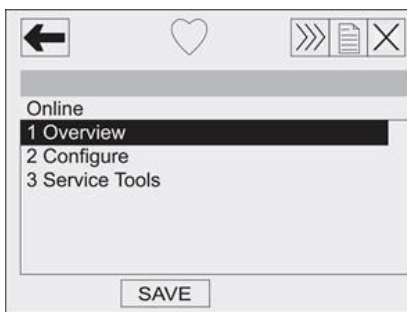

Table 5-1: Traditional Interface Fast Key

A check (✓) indicates the basic configuration parameters. At minimum, these parameters should be verified as part of the configuration and startup procedure.

	Function	Fast Key sequence
✓	Analog Output Alarm	1, 4, 3, 2, 4
	Burst Mode Control	1, 4, 3, 3, 3
	Burst Option	1, 4, 3, 3, 4
	Calibration	1, 2, 3
✓	Damping	1, 3, 5
	Date	1, 3, 4, 1
	Descriptor	1, 3, 4, 2
	Digital To Analog Trim (4–20 mA Output)	1, 2, 3, 2, 1
	Disable Local Span/Zero Adjustment	1, 4, 4, 1, 7
	Field Device Info	1, 4, 4, 1

Table 5-1: Traditional Interface Fast Key (continued)

	Function	Fast Key sequence
	Keypad Input	1, 2, 3, 1, 1
	Loop Test	1,2, 2
	Lower Range Value	4, 1
	Lower Sensor Trim	1, 2, 3, 3, 2
	Message	1, 3, 4, 3
	Meter Type	1, 3, 6, 1
	Number of Requested	1, 4, 3, 3, 2
	Output Trim	1, 2, 3, 2
	Percent Range	1, 1, 2
	Poll Address	1, 4, 3, 3, 1
✓	Range Values	1, 3, 3
	Rerange	1, 2, 3, 1
	Scaled D/A Trim (4–20 mA)	1, 2, 3, 2, 2
	Self Test (Transmitter)	1, 2, 1, 1
	Sensor Info	1, 4, 4, 2
	Sensor Trim (Full Trim)	1, 2, 3, 3
	Sensor Trim Points	1, 2, 3, 3, 5
	Status	1, 2, 1, 2
✓	Tag	1, 3, 1
	Transmitter Security (Write Protect)	1, 3, 4, 4
✓	Units (Process Variable)	1, 3, 2
	Upper Range Value	5, 2
	Upper Sensor Trim	1, 2, 3, 3, 3
	Zero Trim	1, 2, 3, 3, 1

Table 5-2: Device Dashboard Fast Keys

A check (✓) indicates the basic configuration parameters. At minimum, these parameters should be verified as part of the configuration and startup procedure.

	Function	Fast Key Sequence		
	Field Revision	Rev 3	Rev 5	Rev 7
	HART Revision	HART 5	HART 5	HART 7
✓	Alarm and Saturation Levels	N/A	2, 2, 2, 5, 7	2, 2, 2, 5, 7
✓	Damping	2, 2, 1, 2	2, 2, 1, 1, 5	2, 2, 1, 1, 5
✓	Range Values	2, 2, 2	2, 2, 2	2, 2, 2
✓	Tag	2, 2, 6, 1, 1	2, 2, 7, 1, 1	2, 2, 7, 1, 1
✓	Transfer Function	2, 2, 1, 3	2, 2, 1, 1, 6	2, 2, 1, 1, 6
✓	Units	2, 2, 1, 1	2, 2, 1, 1, 4	2, 2, 1, 1, 4
	Burst Mode	2, 2, 4, 1	2, 2, 5, 3	2, 2, 5, 3
	Custom Display Configuration	2, 2, 3	2, 2, 4	2, 2, 4
	Date	2, 2, 6, 1, 4	2, 2, 7, 1, 3	2, 2, 7, 1, 4
	Descriptor	2, 2, 6, 1, 5	2, 2, 7, 1, 4	2, 2, 7, 1, 5
	Digital to Analog Trim (4–20 mA Output)	3, 4, 2	3, 4, 2	3, 4, 2
	Disable Configuration Buttons	2, 2, 5, 2	2, 2, 6, 3	2, 2, 6, 3
	Rerange with Keypad	2, 2, 2	2, 2, 2, 1	2, 2, 2, 1
	Loop Test	3, 5, 1	3, 5, 1	3, 5, 1
	Upper Sensor Trim	3, 4, 1, 1	3, 4, 1, 1	3, 4, 1, 1
	Lower Sensor Trim	3, 4, 1, 2	3, 4, 1, 2	3, 4, 1, 2
	Message	2, 2, 6, 1, 5	2, 2, 7, 1, 5	2, 2, 7, 1, 6
	Sensor Temperature/Trend	3, 3, 2	3, 3, 3	3, 3, 3
	Digital Zero Trim	3, 4, 1, 3	3, 4, 1, 3	3, 4, 1, 3
	Password	N/A	2, 2, 6, 4	2, 2, 6, 5
	Scaled Variable	N/A	3, 2, 2	3, 2, 2
	HART Revision 5 to HART Revision 7 switch	N/A	2, 2, 5, 2, 3	2, 2, 5, 2, 3
	Long Tag	N/A	N/A	2, 2, 7, 1, 2
	Find Device	N/A	N/A	3, 4, 5
	Simulate Digital Signal	N/A	N/A	3, 4, 5

5.2 Verifying configuration with LOI

The optional LOI can be used for commissioning the device. The LOI is a two-button design with internal and external buttons. The internal buttons are located on the display of the transmitter, while the external buttons are located underneath the top metal tag. To activate the LOI, push any button. LOI button functionality is shown on the bottom corners of the display. See [Table 5-3](#) and [Figure 5-4](#) for button operation and menu information.

Figure 5-3: Internal and External LOI Buttons

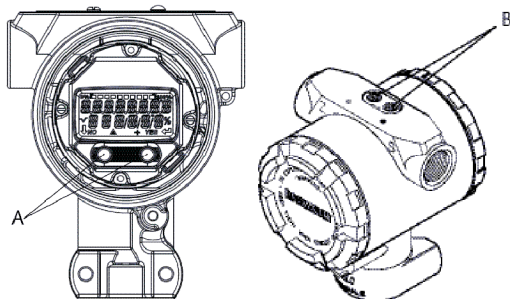

- A. Internal buttons
- B. External buttons

Note

See [Figure 12](#) on [page 15](#) to confirm external button functionality.

Table 5-3: LOI Button Operation



Button		
Left	No	SCROLL
Right	Yes	ENTER

Figure 5-4: LOI Menu



5.3 Switch HART Revision mode

Task steps to switch the HART Revision mode from the generic menu.

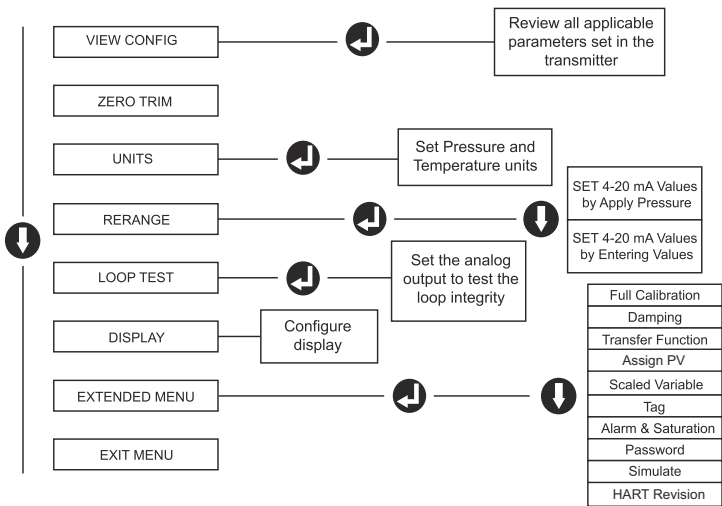
If the HART configuration tool is not capable of communicating with HART Revision 7, the Rosemount 2088, 2090F, or 2090P will load a generic menu with limited capability. The following procedures will switch the HART revision mode from the generic menu:

Procedure

Go to **Manual Setup** → **Device Information** → **Identification** → **Message**

- a) To change to HART Revision 5, Enter: "**HART5**" in the Message field.
- b) To change to HART Revision 7, Enter: "**HART7**" in the Message field.

6 Trim the transmitter

Devices are calibrated by the factory. Once installed, it is recommended to perform a zero trim on gage and absolute pressure transmitters to eliminate error due to mounting position or static pressure effects. A zero trim can be performed using either a Field Communicator or configuration buttons.

For instructions using AMS Device Manager, see the [Rosemount 2088 Reference Manual](#).

⚠ CAUTION

It is not recommended to zero an absolute transmitter.

Procedure

Select trim procedure.

- a) Analog zero trim – sets the analog output to 4 mA.
Also referred to as a “rerange,” it sets the Lower Range Value(LRV) equal to the measured pressure. The display and digital HART output remains unchanged.
- b) Digital zero trim – recalibrates the sensor to zero.
The LRV is unaffected. The pressure value will be zero (on display and HART output). 4 mA point may not be at zero. This requires that the factory calibrated zero pressure is within a range of three percent of the URV [$0 \pm 3\% \times \text{URV}$].

Example

URV = 250 inH₂O

Applied zero pressure = $0.03 \times 250 \text{ inH}_2\text{O} = 7.5 \text{ inH}_2\text{O}$ (compared to factory settings) values outside this range will be rejected by the transmitter

6.1 Trimming with a Field Communicator

Procedure

1. Connect the Field Communicator, see [Connect the wiring and power up](#) for instructions.
2. Follow the HART menu to perform the desired zero trim.

Table 6-1: Zero Trim Fast Keys

	Analog zero (Set 4 mA)	Digital zero
Fast Key sequence	3, 4, 2	3, 4, 1, 3

6.2 Trimming with configuration buttons

A zero trim is to be performed using one of the three possible sets of external configuration buttons located under the top tag.

To access the configuration buttons, loosen the screw and slide the tag on the top of the transmitter. Confirm the functionality using [Figure 5-3](#).

Figure 6-1: External Configuration Buttons

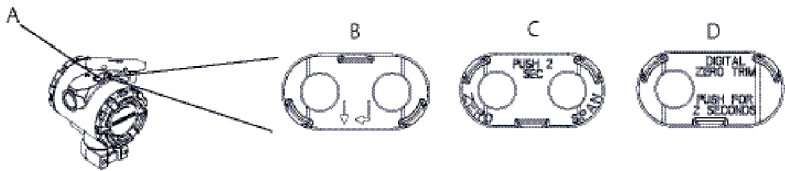

- A. Configuration buttons
- B. LOI
- C. Analog zero and span
- D. Digital zero

6.3 Perform trim with LOI (option M4)

Use the following procedures to perform a zero trim:

Procedure

1. Set the transmitter pressure.
2. See [Figure 5-4](#) for the operating menu.
 - a) Select **Rerange** to perform an analog zero trim.
 - b) Select **Zero Trim** to perform a digital zero trim.

6.4 Perform trim with analog zero and span (option D4 or standard on Rosemount 2090F and 2090P)

Procedure

1. Set the transmitter pressure.
2. Press and hold the zero button for two seconds to perform an analog zero trim.

6.5 Perform trim with digital zero (option DZ)

Procedure

1. Set the transmitter pressure.
2. Press and hold the zero button for two seconds to perform a digital zero trim.

7 Safety Instrumented Systems (SIS) installation

For safety certified installations, refer to Rosemount 2090 [Manual Supplement](#) for installation procedure and system requirements.

8 Product certifications

8.1 Rosemount 2090

Rev 2.2

8.1.1 European Directive information

A copy of the EU Declaration of Conformity can be found at the end of this guide. The most recent revision of the EU Declaration of Conformity can be found at [Emerson.com/Rosemount](https://www.emerson.com/Rosemount).

8.1.2 Ordinary certification location from CSA

The product has been examined and tested to determine that the design meets the basic electrical, mechanical, and fire protection requirements by CSA, a nationally recognized test laboratory (NRTL) as accredited by the Federal Occupational Safety and Health Administration (OSHA).

8.1.3 North America

E5 USA Explosionproof (XP) and Dust-Ignitionproof (DIP)

Certificate: 1015441

Standards: FM Class 3600 - 2011, FM, Class 3615 - 2006, FM class 3616 - 2011, FM Class 3810 - 2005, ANSI/NEMA 250 - 1991

Markings: XP CL I, DIV 1, GP B, C, D; DIP CL II, DIV 1, GP E, F, G; CL III, DIV 1; T5(-40 °C ≤ T_a ≤ +85 °C); Conduit Seal Not Required; Type 4X

I5 USA Intrinsic Safety (IS) and Nonincendive (NI)

Certificate: 1015441

Standards: FM Class 3600 - 2011, FM Class 3610 - 2010, FM Class 3611 - 2004, FM Class 3810 - 2005

Markings: IS CL I, DIV 1, GP A, B, C, D; CL II, DIV 1, GP E, F, G; Class III T4(-50 °C ≤ T_a ≤ +70 °C); when connected per Rosemount drawing 02088-1024; NI CL 1, DIV 2, GP A, B, C, D; Type 4x

C6 Canada Explosionproof, Intrinsic Safety and Division 2, Dust-Ignitionproof

Certificate: 1015441

Standards: CAN/CSA C22.2 No. 0-M91 (R2001), CSA Std C22.2 No. 25-1966, CSA Std C22.2 No. 30-M1986, CAN/CSA-C22.2 No. 94-M91, CSA Std C22.2 No. 142-M1987, CAN/CSA-C22.2 No.

157-92, CSA Std C22.2 No. 213-M1987, ANSI-ISA-12.27.01-2003

Markings: Explosionproof for Class I, Division 1, Groups B, C and D; Class II, Groups E, F, and G; Class III; Intrinsically Safe Class I, Division 1 when connected in accordance with Rosemount drawing 02088-1024, Temperature Code T3C; Ex ia; Class I Division 2 Groups A, B, C and D; Type 4X; Factory Sealed

8.1.4 Europe

ED ATEX Flameproof

Certificate: KEMA97ATEX2378X

Standards: EN60079-0:2012 + A11:2013, EN60079-1:2014, EN60079-26:2015

Markings:  II 1/2 G Ex db IIC T6...T4 Ga/Gb, T6(-60 °C ≤ T_a ≤ +70 °C), T4/T5(-60 °C ≤ T_a ≤ +80 °C);

Special Conditions for Safe Use (X):

1. This device contains a thin wall diaphragm. Installation, maintenance and use shall take into account the environmental conditions to which the diaphragm will be subjected. The manufacturer's instructions for installation and maintenance shall be followed in detail to assure safety during its expected lifetime.
2. Flameproof joints are not intended for repair.
3. Non-standard paint options may cause risk from electrostatic discharge. Avoid installations that could cause electrostatic build-up on painted surfaces, and only clean the painted surfaces with a damp cloth. If paint is ordered through a special option code, contact the manufacturer for more information.

Table 8-1: Process Connection Temperature

Temperature class	Process connection temperature	Ambient temperature
T6	-60 °C to +70 °C	-60 °C to +70 °C
T5	-60 °C to +80 °C	-60 °C to +80 °C
T4	-60 °C to +120 °C	-60 °C to +80 °C

I1 ATEX Intrinsic Safety

Certificate: BAS00ATEX1166X

Standards: EN60079-0:2012+A11:2013, EN60079-11:2012

Markings:  II 1 G Ex ia IIC T4 Ga ($-55\text{ °C} \leq T_a \leq +70\text{ °C}$)

Table 8-2: Input Parameters

Parameters	HART
Voltage U_i	30 V
Current I_i	200 mA
Power P_i	0.9 W
Capacitance C_i	0.012 μF

Special Conditions for Safe Use (X):

1. The apparatus is not capable of withstanding the 500 V insulation test required by EN60079-11. This must be taken into account when installing the apparatus.
2. The enclosure may be made of aluminum alloy and given a protective polyurethane paint finish; however, care should be taken to protect it from impact or abrasion if located in a Zone 0 environment.

N1 ATEX Type n

Certificate: BAS00ATEX3167X

Standards: EN60079-0:2012+A11:2013, EN60079-15:2010

Markings:  II 3 G Ex nA IIC T5 Gc ($-55\text{ °C} \leq T_a \leq +70\text{ °C}$)

Special Conditions for Safe Use (X):

1. When fitted with a transient suppression terminal block, the equipment is not capable of withstanding the 500 V insulation test that is required by EN60079-15. This must be taken into account when installing the apparatus.

ND ATEX Dust

Certificate: BAS01ATEX1427X

Standards: EN60079-0:2012+A11:2013, EN60079-31:2009

Markings:  II 1 D Ex t IIIC T50 °C T₅₀₀ 60 °C Da

Special Conditions for Safe Use (X):

1. Cable entries must be used which maintain the ingress protection of the enclosure to at least IP66.

2. Unused cable entries must be filled with suitable blanking plugs which maintain the ingress protection of the enclosure to at least IP66.
3. Cable entries and blanking plugs must be suitable for the ambient range of the apparatus and capable of withstanding a 7J impact test.

8.1.5 International

K7 IECEx Flameproof

Certificate: IECEx KEM 06.0021X

Standards: IEC60079-0:2011, IEC60079-1:2014, IEC60079-26:2014

Markings: Ex db IIC T6...T4 Ga/Gb, T6(-60 °C ≤ T_a ≤ +70 °C), T4/T5(-60 °C ≤ T_a ≤ +80 °C)

Table 8-3: Process Connection Temperature

Temperature class	Process connection temperature	Ambient temperature
T6	-60 °C to +70 °C	-60 °C to +70 °C
T5	-60 °C to +80 °C	-60 °C to +80 °C
T4	-60 °C to +120 °C	-60 °C to +80 °C

Special Conditions for Safe Use (X):

1. The device contains a thin wall diaphragm less than 1 mm thickness that forms a boundary between EPL Ga (process connection) and EPL Gb (all other parts of the equipment). The model code and datasheet are to be consulted for details of the diaphragm material. Installation, maintenance and use shall take into account the environmental conditions to which the diaphragm shall be subjected. The manufacturer's instructions for installation and maintenance shall be followed in detail to assure safety during its expected lifetime.
2. Flameproof joints are not intended for repair.
3. Non-standard paint options may cause risk from electrostatic discharge. Avoid installations that could cause electrostatic build-up on painted surfaces, and only clean the painted surfaces with a damp cloth. If paint is ordered through a special option code, contact the manufacturer for more information.

IECEx Dust: see Approval Option NK

Certificate: IECEx BAS 12.0071X

Standards: IEC60079-0:2011, IEC60079-11:2011

Markings: Ex ia IIC T4 Ga ($-55\text{ °C} \leq T_a \leq +70\text{ °C}$)

Table 8-4: Input Parameters

Parameter	HART
Voltage U_i	30 V
Current I_i	200 mA
Power P_i	0.9 W
Capacitance C_i	0.012 μF

Special Conditions for Safe Use (X):

1. When fitted with a transient suppression terminal block, the Rosemount 2088 is incapable of passing the 500 V isolation test. This must be taken into account during installation.
2. The enclosure may be made of aluminum alloy and given a protective polyurethane paint finish; however, care should be taken to protect it from impact or abrasion if located in a Zone 0 environment.

IECEX Type n

Certificate: IECEx BAS 12.0072X

Standards: IEC60079-0:2011, IEC60079-15:2010

Markings: Ex nA IIC T5 Gc ($-40\text{ °C} \leq T_a \leq +70\text{ °C}$)

Special Condition for Safe Use (X):

1. When fitted with a transient suppression terminal block, the Rosemount 2088 is incapable of passing the 500 V isolation test. This must be taken into account during installation.

NK IECEx Dust

Certificate: IECEx BAS12.0073X

Standards: IEC60079-0:2011, IEC60079-31:2008

Markings: Ex t IIIC T50 °C T₅₀₀ 60 °C Da

Table 8-5: Input Parameters

Parameter	HART
Voltage U_i	36 Vdc

Special Conditions for Safe Use (X):

1. Cable entries must be used which maintain the ingress protection of the enclosure to at least IP66.
2. Unused cable entries must be filled with suitable blanking plugs which maintain the ingress protection of the enclosure to at least IP66.
3. Cable entries and blanking plugs must be suitable for the ambient temperature range of the apparatus and capable of withstanding a 7J impact test.

8.1.6 China

E3 China Flameproof

Certificate: GYJ15.1506X

Standards: GB3836.1-2010, GB3836.2-2010

Markings: Ex d IIC T6/T4 Gb, T6(-20 °C ≤ T_a ≤ +40 °C), T4(-20 °C ≤ T_a ≤ +80 °C)

Special Conditions for Safe Use (X):

The ambient temperature is as follows:

T _a	Temperature class
-20 °C ≤ T _a ≤ 80 °C	T4
-20 °C ≤ T _a ≤ 40 °C	T6

1. The earth connection facility on the enclosure should be connected reliably.
2. During installation in hazardous location, cable glands, conduits, and blanking plugs, certified by state-appointed inspection bodies with Ex d IIC type of protection, should be used.
3. During installation, use and maintenance in explosive gas atmospheres, observe the warning “Do not open when energized”.
4. During installation, there should be no mixture harm to flameproof housing.
5. End user is not permitted to change any components insides, but to settle the problem in conjunction with manufacturer to avoid damage to the product.
6. Maintenance should be done in non-hazardous location.

7. During installation, use and maintenance of this product, observe the following standards: GB3836.13-2013, GB3836.15-2000, GB3836.16-2006, GB50257-2014

I3 China Intrinsic Safety

Certificate: GYJ15.1508X

Standards: GB3836.1-2010, GB3836.4-2010, GB3836.20-2010

Markings: Ex ia IIC T4 Ga

Special Conditions for Safe Use (X):

1. The enclosure may contain light metal, attention should be taken to avoid ignition hazard due to impact or friction when used in Zone 0.
2. When transient protection board is chosen (option code T1), this apparatus is not capable of withstanding the 500 V r.m.s insulation test required by Clause 6.3.12 of GB3836.4-2010.

8.1.7 Technical Regulations Customs Union (EAC)

EM EAC Flameproof

Certificate: RU C-US.GB05.B.01197

Markings: Ga/Gb Ex d IIC T4/T6 X, T4($-40\text{ }^{\circ}\text{C} \leq T_a \leq +80\text{ }^{\circ}\text{C}$), T6($-40\text{ }^{\circ}\text{C} \leq T_a \leq +40\text{ }^{\circ}\text{C}$)

Special Condition for Safe Use (X):

1. See certificate for special conditions.

IM EAC Intrinsically Safe

Certificate: RU C-US.GB05.B.01197

Markings: 0Ex ia IIC T4 Ga X, T4($-55\text{ }^{\circ}\text{C} \leq T_a \leq +70\text{ }^{\circ}\text{C}$)

Special Condition for Safe Use (X):

1. See certificate for special conditions.

8.1.8 Combinations

- K1** Combination of ED, I1, ND, and N1
- K5** Combination of E5 and I5
- K6** Combination of C6, ED, and I1
- KB** Combination of K5 and C6

- KM** Combination of EM and IM
- KH** Combination of ED, I1, K5

8.1.9 Conduit Plugs and Adapters

IECEx Flameproof and Increased Safety

Certificate: IECEx FMG 13.0032X

Standards: IEC60079-0:2011, IEC60079-1:2007-04, IEC60079-7:2006-07

Markings: Ex de IIC Gb

ATEX Flameproof and Increased Safety

Certificate: FM13ATEX0076X

Standards: EN60079-0:2012, EN60079-1:2007, EN60079-7:2007

Markings: Ex II 2 G Ex de IIC Gb

Table 8-6: Conduit Plug Thread Sizes

Thread	Identification mark
M20 x 1.5–6g	M20
½-14 NPT	¼ NPT
G½A	G¼

Table 8-7: Thread Adapter Thread Sizes

Male thread	Identification mark
M20 x 1.5–6 H	M20
½–14 NPT	¼–14 NPT
¾–14 NPT	¾–14 NPT
Female thread	Identification mark
M20 x 1.5–6 H	M20
½–14 NPT	¼–14 NPT
PG 13.5	PG 13.5

Special Conditions for Safe Use (X):

1. When the thread adapter or blanking plug is used with an enclosure in type of protection increased safety “e” the entry thread shall be suitably sealed in order to maintain the ingress protection rating (IP) of the enclosure.

2. The blanking plug shall not be used with an adapter.
3. Blanking Plug and Threaded Adapter shall be either NPT or Metric thread forms. G½ and PG 13.5 thread forms are only acceptable for existing (legacy) equipment installations.

8.2 Rosemount 2088

Rev 1.26

8.2.1 European Directive information

A copy of the EU Declaration of Conformity can be found at the end of this guide. The most recent revision of the EU Declaration of Conformity can be found at [Emerson.com/Rosemount](https://www.emerson.com/Rosemount).

8.2.2 Ordinary certification location from CSA

The product has been examined and tested to determine that the design meets the basic electrical, mechanical, and fire protection requirements by CSA, a nationally recognized test laboratory (NRTL) as accredited by the Federal Occupational Safety and Health Administration (OSHA).

8.2.3 North America

E5 USA Explosionproof (XP) and Dust-Ignitionproof (DIP)

Certificate: 1V2A8.AE

Standards: FM Class 3600 - 2011, FM, Class 3615 - 2006, FM class 3616 - 2011, FM Class 3810 - 2005

Markings: XP CL I, DIV 1, GP B, C, D; DIP CL II, DIV 1, GP E, F, G; CL III; T5(-50 °C ≤ T_a ≤ +85 °C); Factory Sealed; Type 4X

I5 USA Intrinsic Safety (IS) and Nonincendive (NI)

Certificate: 1015441

Standards: FM Class 3600 – 2011, FM Class 3610 – 2010, FM Class 3611 – 2004, FM Class 3810 – 2005

Markings: IS CL I, DIV 1, GP A, B, C, D; CL II, DIV 1, GP E, F, G; Class III; DIV 1 when connected per Rosemount drawing 02088-1024; NI CL 1, DIV 2, GP A, B, C, D; T4(-50 °C ≤ T_a ≤ +70 °C); Type 4x C6

C6 Canada Explosionproof, Intrinsic Safety and Division 2, Dust-Ignitionproof

Certificate: 1015441

Standards: CAN/CSA C22.2 No. 0-M91 (R2001), CSA Std C22.2 No. 25-1966, CSA Std C22.2 No. 30-M1986, CAN/CSA-C22.2 No. 94-M91, CSA Std C22.2 No. 142-M1987, CAN/CSA-C22.2 No. 157-92, CSA Std C22.2 No. 213-M1987, ANSI-ISA-12.27.01-2003

Markings: Explosionproof for Class I, Division 1, Groups B, C and D; Class II, Groups E, F, and G; Class III; Intrinsically Safe Class I, Division 1 when connected in accordance with Rosemount drawing 02088-1024, Temperature Code T3C; Ex ia; Class I Division 2 Groups A, B, C and D; Type 4X; Factory Sealed; Single Seal

8.2.4 Europe

ED ATEX Flameproof

Certificate: KEMA97ATEX2378X

Standards: EN IEC 60079-0:2018, EN 60079-1:2014, EN 60079-26:2015

Markings:  II 1/2 G Ex db IIC T6...T4 Ga/Gb, T6(-60 °C ≤ T_a ≤ +70 °C), T4/T5(-60 °C ≤ T_a ≤ +80 °C);

Table 8-8: Process Connection Temperature

Temperature class	Process connection temperature	Ambient temperature
T6	-60 °C to +70 °C	-60 °C to +70 °C
T5	-60 °C to +80 °C	-60 °C to +80 °C
T4	-60 °C to +120 °C	-60 °C to +80 °C

Special Conditions for Safe Use (X):

1. This device contains a thin wall diaphragm less than 1 mm thick that forms a boundary between Category 1G (process connection) and Category 2G (all other parts of the equipment). The model code and datasheet are to be consulted for details of the diaphragm material. During installation, maintenance and use the environmental conditions to which the diaphragm will be subjected shall be taken into account. The manufacturer's instructions for installation and maintenance shall be followed in detail to assure safety during its expected lifetime.
2. Flameproof joints are not intended for repair.

3. Non-standard paint options may cause risk from electrostatic discharge. Avoid installations that could cause electrostatic build-up on painted surfaces, and only clean the painted surfaces with a damp cloth. If paint is ordered through a special option code, contact the manufacturer for more information.
4. Appropriate cable, glands and plugs need to be suitable for a temperature of 5 °C greater than maximum specified temperature for location where installed.

Conduit/Cable Entries:

Unless otherwise marked, the conduit/cable entries in the housing enclosure use a ½-14 NPT form. Only use plugs, adapters, glands, or conduit with a compatible thread form when closing these entries. Entries marked M20 are M20 x 1.5 thread form. On devices with multiple conduit entries, all entries will have the same thread form. When installing in a hazardous location, use only appropriately listed or Ex certified plugs, glands, or adapters in cable/conduit entries.

I1 ATEX Intrinsic Safety

Certificate: BAS00ATEX1166X

Standards: EN60079-0:2012 + A11:2013, EN60079-11:2012

Markings: Ex II 1 G Ex ia IIC T4 Ga (-55 °C ≤ T_a ≤ +70 °C)

Table 8-9: Input Parameters

Parameters	HART
Voltage U _i	30 V
Current I _i	200 mA
Power P _i	0.9 W
Capacitance C _i	0.012 μF

Special Conditions for Safe Use (X):

1. The apparatus is not capable of withstanding the 500 V insulation test required by EN60079-11. This must be taken into account when installing the apparatus.
2. The enclosure may be made of aluminum alloy and given a protective polyurethane paint finish; however, care should be taken to protect it from impact or abrasion if located in a Zone 0 environment.

N1 ATEX Type n

Certificate: BAS00ATEX3167X

Standards: EN60079-0:2012 + A11:2013, EN60079-15:2010

Markings: Ex II 3 G Ex nA IIC T5 Gc ($-40\text{ °C} \leq T_a \leq +70\text{ °C}$)

Special Condition for Safe Use (X):

1. This apparatus is not capable of withstanding the 500 V insulation test required by EN60079-15. This must be taken into account when installing the apparatus.

ND ATEX Dust

Certificate: BAS01ATEX1427X

Standards: EN60079-0:2012 + A11:2013, EN60079-31:2009

Markings: Ex II 1 D Ex t IIIC T50°C T₅₀₀ 60°C Da

Special Conditions for Safe Use (X):

1. Cable entries must be used which maintain the ingress protection of the enclosure to at least IP66.
2. Unused cable entries must be filled with suitable blanking plugs which maintain the ingress protection of the enclosure to at least IP66.
3. Cable entries and blanking plugs must be suitable for the ambient range of the apparatus and capable of withstanding a 7J impact test.

8.2.5 International

E7 IECEx Flameproof

Certificate: IECEx KEM 06.0021X

Standards: IEC 60079-0:2017, IEC 60079-1:2014, IEC 60079-26:2014

Markings: Ex db IIC T6...T4 Ga/Gb, T6 ($-60\text{ °C} \leq T_a \leq +70\text{ °C}$), T4/T5 ($-60\text{ °C} \leq T_a \leq +80\text{ °C}$)

Special Conditions for Safe Use (X):

1. This device contains a thin wall diaphragm less than 1 mm thick that forms a boundary between EPL Ga (process connection) and EPL Gb (all other parts of the equipment). The model code and datasheet are to be consulted for details of the diaphragm material. During installation, maintenance and use the environmental conditions to which the diaphragm will be subjected shall be taken into account. The manufacturer's instructions for installation and maintenance shall be followed in detail to assure safety during its expected lifetime.

2. Flameproof joints are not intended for repair.
3. Non-standard paint options may cause risk from electrostatic discharge. Avoid installations that could cause electrostatic build-up on painted surfaces, and only clean the painted surfaces with a damp cloth. If paint is ordered through a special option code, contact the manufacturer for more information.
4. Appropriate cable, glands and plugs need to be suitable for a temperature of 5°C greater than maximum specified temperature for location where installed.

Conduit/Cable Entries:

Unless otherwise marked, the conduit/cable entries in the housing enclosure use a ½-14 NPT form. Only use plugs, adapters, glands, or conduit with a compatible thread form when closing these entries. Entries marked M20 are M20 x 1.5 thread form. On devices with multiple conduit entries, all entries will have the same thread form. When installing in a hazardous location, use only appropriately listed or Ex certified plugs, glands, or adapters in cable/conduit entries.

I7 IECEx Intrinsic Safety

Certificate:	IECEX BAS 12.0071X
Standards:	IEC60079-0:2011, IEC60079-11:2011
Markings:	Ex ia IIC T4 Ga (-55 °C ≤ T _a ≤ +70 °C)

Table 8-10: Input Parameters

Parameter	HART
Voltage U _i	30 V
Current I _i	200 mA
Power P _i	0.9 W
Capacitance C _i	0.012 μF

Special Conditions for Safe Use (X):

1. When fitted with a transient suppression terminal block, the Rosemount 2088 is incapable of passing the 500 V isolation test. This must be taken into account during installation.
2. The enclosure may be made of aluminum alloy and given a protective polyurethane paint finish; however, care should be taken to protect it from impact or abrasion if located in a Zone 0 environment.

N7 IECEx Type n

- Certificate:** IECEx BAS 12.0072X
- Standards:** IEC60079-0:2011, IEC60079-15:2010
- Markings:** Ex nA IIC T5 Gc ($-40\text{ }^{\circ}\text{C} \leq T_a \leq +70\text{ }^{\circ}\text{C}$)

Special Condition for Safe Use (X):

- When fitted with a transient suppression terminal block, the Rosemount 2088 is incapable of passing the 500 V isolation test. This must be taken into account during installation.

NK IECEx Dust

- Certificate:** IECEx BAS12.0073X
- Standards:** IEC60079-0:2011, IEC60079-31:2008
- Markings:** Ex t IIIC T50 $^{\circ}\text{C}$ T₅₀₀ 60 $^{\circ}\text{C}$ Da

Table 8-11: Input Parameters

Parameter	HART
Voltage U _i	36 V

Special Conditions for Safe Use (X):

- Cable entries must be used which maintain the ingress protection of the enclosure to at least IP66.
- Unused cable entries must be filled with suitable blanking plugs which maintain the ingress protection of the enclosure to at least IP66.
- Cable entries and blanking plugs must be suitable for the ambient temperature range of the apparatus and capable of withstanding a 7J impact test.

8.2.6 Brazil

E2 Brazil Flameproof

- Certificate:** UL-BR 15.0728X
- Standards:** ABNT NBR IEC60079-0:2013, ABNT NBR IEC 60079-1:2016, ABNT NBR IEC 60079-26:2016
- Markings:** Ex db IIC T6...T4 Ga/Gb, T4/T5 ($-60\text{ }^{\circ}\text{C} \leq T_a \leq +80\text{ }^{\circ}\text{C}$), T6 ($-60\text{ }^{\circ}\text{C} \leq T_a \leq +70\text{ }^{\circ}\text{C}$)

Table 8-12: Process Connection Temperature

Temperature class	Process connection temperature	Ambient temperature
T6	-60 °C to +70 °C	-60 °C to +70 °C
T5	-60 °C to +80 °C	-60 °C to +80 °C
T4	-60 °C to +120 °C	-60 °C to +80 °C

Special Conditions for Safe Use (X):

1. This device contains a thin wall diaphragm less than 1mm thickness that forms a boundary between zone 0 (process connection) and zone 1 (all other parts of the equipment). The model code and datasheet are to be consulted for details of the diaphragm material. Installations, maintenance and use shall take into account the environmental conditions to which the diaphragm will be subjected. The manufacturer's instructions for installation and maintenance shall be followed in detail to assure safety during its expected lifetime.
2. Flameproof joints are not intended for repair.
3. Non-standard paint options may cause risk from electrostatic discharge. Avoid installations that could cause electrostatic build-up on painted surfaces, and only clean the painted surfaces with a damp cloth. If paint is ordered through a special option code, contact the manufacturer for more information.

I2 Brazil Intrinsic Safety**Certificate:** UL-BR 13.0246X**Standards:** ABNT NBR IEC60079-0:2008 + Errata 1:2011, ABNT NBR IEC60079-11:2009**Markings:** Ex ia IIC T4 Ga (-55 °C ≤ T_a ≤ +70 °C)

Parameter	HART
Voltage U _i	30 V
Current I _i	200 mA
Power P _i	0.9 W
Capacitance C _i	0.012 μF

Special Conditions for Safe Use (X):

1. When fitted with a transient suppression terminal block, the Rosemount 2088 is incapable of passing the 500 V isolation test. This must be taken into account when installing the equipment.
2. The enclosure may be made of aluminum alloy and given a protective polyurethane paint finish; however, care should be taken to protect it from impact or abrasion if located in Zone 0.

8.2.7 China

E3 China Flameproof

Certificate: GYJ20.1548X

Standards: GB3836.1-2010, GB3836.2-2010 , GB3836.20-2010

Markings: Ex d IIC T6~T4 Ga/Gb,

- 产品安全使用特殊条件
证书编号后缀“X”表明产品具有安全使用特殊条件：涉及隔爆接合面的维修须联系产品制造商
- 产品使用注意事项
 1. 产品使用环境温度为：

温度组别	环境温度
T6	-60 °C ≤ T _a ≤ + 70 °C
T5	-60 °C ≤ T _a ≤ + 80 °C
T4	-60 °C ≤ T _a ≤ + 80 °C

2. 产品外壳设有接地端子，用户在使用时应可靠接地
3. 安装现场应不存在对产品外壳有腐蚀作用的有害气体
4. 现场安装时，电缆引入口须选用经国家指定的防爆检验机构检验认可、具有 Ex dIIC Gb 防爆等级的电缆引入装置或堵封件，冗余电缆引入口须用堵封件有效密封
5. 用于爆炸性气体环境中，现场安装、使用和维护必须严格遵守“断电后开盖！”的警告语
6. 用户不得自行更换该产品的零部件，应会同产品制造商共同解决运行中出现的故障，以杜绝损坏现象的发生
7. 产品的安装、使用和维护应同时遵守产品使用说明书、GB3836.13-2013“爆炸性环境 第 13 部分：设备的修理、检修、修复和改造”、GB3836.15-2000“爆炸性气体环境用电气设备 第 15 部分：危险场所电气安装（煤矿除外）”、GB3836.16-2006“爆炸性气

体环境用电气设备 第 16 部分：电气装置的检查和维护（煤矿除外）”和 GB50257-2014“电气装置安装工程爆炸和火灾危险环境电力装置施工及验收规范”的有关规定

N3 China Type n

Certificate:	GJY20.1111X
Standards:	GB3836.1-2010, GB3836.8-2014
Markings:	Ex nA IIC T5 Gc (-40 °C ≤ T _a ≤ +70 °C)

- 产品安全使用特殊条件
产品防爆合格证号后缀“X”代表产品安全使用有特殊条件：产品选用瞬态保护端子板（c 中包含 T1 选项）时，不能承受 GB3836.8-2014 中规定的 500V 交流有效值试验电压的介电强度试验，安装时需考虑在内
- 产品使用注意事项
 1. 产品使用环境温度范围为：-40 °C ≤ T_a ≤ 70 °C
 2. 最高输入电压：50 V
 3. 现场安装时，电缆引入口须选用经国家指定的防爆检验机构检验认可、具有 Ex e IIC Gb 或 Ex nA IIC Gc 防爆等级的电缆引入装置或堵封件，冗余电缆引入口须用堵封件有效密封。电缆引入装置或堵封件的安装使用必须遵守其使用说明书的要求并保证外壳防护等级达到 IP66（符合 GB/T4208-2017 标准要求）以上
 4. 用户不得自行更换该产品的零部件，应会同产品制造商共同解决运行中出现的故障，以杜绝损坏现象的发生
 5. 产品的安装、使用和维护应同时遵守产品使用说明书、GB3836.13-2013“爆炸性环境 第 13 部分：设备的修理、检修、修复和改造”、GB/T3836.15-2017“爆炸性环境 第 15 部分：电气装置的设计、选型和安装”、GB/T3836.16-2017“爆炸性环境 第 16 部分：电气装置的检查与维护”、GB50257-2014“电气装置安装工程爆炸和火灾危险环境电力装置施工及验收规范”的有关规定

8.2.8 Korea

EP Korea Flameproof

Certificate:	13-KB4BO-0020X, 10-KB4BO-0137X, 19-KA4BO-0989X
Markings:	Ex d IIC T6...T4 Ga/Gb, T4/T5 (-60 °C ≤ T _a ≤ +80 °C), T6 (-60 °C ≤ T _a ≤ +70 °C)

Special Condition for Safe Use (X):

1. See certificate for special conditions.

8.2.9 Japan

E4 Japan Flameproof

Certificate: CML20JPN1313X

Markings: Ex db IIC T6...T4 Ga/Gb, T6 ($-60\text{ °C} \leq T_a \leq +70\text{ °C}$), T4/T5 ($-60\text{ °C} \leq T_a \leq +80\text{ °C}$)

8.2.10 Technical Regulations Customs Union (EAC)

EM EAC Flameproof

Certificate: EAEC RU C-US.EX01.B.00176

Markings: Ga/Gb Ex d IIC T4/T6 X, T4 ($-40\text{ °C} \leq T_a \leq +80\text{ °C}$), T6 ($-40\text{ °C} \leq T_a \leq +40\text{ °C}$)

Special Condition for Safe Use (X):

1. See certificate for special conditions.

IM EAC Intrinsically Safe

Certificate: EAEC RU C-US.EX01.B.00176

Markings: 0Ex ia IIC T4 Ga X ($-55\text{ °C} \leq T_a \leq +70\text{ °C}$)

Special Condition for Safe Use (X):

1. See certificate for special conditions.

8.2.11 Combinations

- K1** Combination of ED, I1, ND, and N1
- K2** Combination of E2 and I2
- K5** Combination of E5 and I5
- K6** Combination of C6, ED, and I1
- K7** Combination of E7, I7, NK, and N7
- KB** Combination of K5 and C6
- KM** Combination of EM and IM
- KH** Combination of ED, I1, and K5

8.2.12 Conduit Plugs and Adapters

IECEx Flameproof and Increased Safety

Certificate Certificate: IECEx FMG 13.0032X

Certificate Standards: IEC60079-0:2011, IEC60079-1:2007-04, IEC60079-7:2006-07

Certificate Markings: Ex de IIC Gb

ATEX Flameproof and Increased Safety

Certificate: FM13ATEX0076X

Standards: EN60079-0:2012, EN60079-1:2007, EN60079-7:2007

Markings: Ex II 2 G Ex de IIC Gb

Table 8-13: Conduit Plug Thread Sizes

Thread	Identification mark
M20 x 1.5–6G	M20
½–14 NPT	½ NPT
G½A	G½

Table 8-14: Thread Adapter Thread Sizes

Male thread	Identification mark
M20 x 1.5–6H	M20
½–14 NPT	½–14 NPT
¾–14 NPT	¾–14 NPT
Female thread	Identification mark
M20 x 1.5–6H	M20
½–14 NPT	½–14 NPT
G½	G½

Special Conditions for Safe Use (X):

1. When the thread adapter or blanking plug is used with an enclosure in type of protection increased safety “e” the entry thread shall be suitably sealed in order to maintain the ingress protection rating (IP) of the enclosure.
2. The blanking plug shall not be used with an adapter.

3. Blanking Plug and Threaded Adapter shall be either NPT or Metric thread forms. G½ thread forms are only acceptable for existing (legacy) equipment installations.

8.2.13 Additional Certifications

SBS American Bureau of Shipping (ABS) Type Approval

Certificate: 18-HS1814314-PDA

Intended Use: Measurement of either gauge or absolute pressure for liquid, gas, and vapor

ABS Rules: 2014 Steel Vessels Rules 1-1-4/7.7, 1-1-Appendix 3, 4-8-3/1.7, 4-8-3/13.1, 4-8-3/13.3.1 & 13.3.2, 4-8-4/27.5.1

SBV Bureau Veritas (BV) Type Approval

Certificate: 23156/B0 BV

Requirements: Bureau Veritas Rules for the Classification of Steel Ships

Application: Class notations: AUT-UMS, AUT-CCS, AUT-PORT, and AUT-IMS; Pressure transmitter type 2088 cannot be installed on diesel engines.

SDN Det Norske Veritas (DNV) Type Approval

Certificate: TAA000004F

Intended Use: DNV GL Rules for Classification - Ships and offshore units

Application:

Location classes



Temperature	D
Humidity	B
Vibration	A
EMC	B
Enclosure	D



SLL Lloyds Register (LR) Type Approval

Certificate: LR21173788TA

Application: Environmental categories ENV1, ENV2, ENV3, and ENV5

9 Rosemount 2088 and 2090 Declaration of Conformity

	
EU Declaration of Conformity No: RMD 1010 Rev. O	
<p>We,</p> <p>Rosemount, Inc. 8200 Market Boulevard Chanhassen, MN 55317-9685 USA</p> <p>declare under our sole responsibility that the product,</p> <p>Rosemount Pressure Transmitters 3051P, 2051G, 2088, and 2090</p> <p>manufactured by,</p> <p>Rosemount, Inc. 8200 Market Boulevard Chanhassen, MN 55317-9685 USA</p> <p>to which this declaration relates, is in conformity with the provisions of the European Union Directives, including the latest amendments, as shown in the attached schedule.</p> <p>Assumption of conformity is based on the application of the harmonized standards and, when applicable or required, a European Union notified body certification, as shown in the attached schedule.</p>	
 _____ (signature)	_____ Vice President of Global Quality (function)
_____ Chris LaPoint (name)	_____ 28-Jan-20, Shakopee, MN USA (date of issue)
Page 1 of 3	

EU Declaration of Conformity

No: RMD 1010 Rev. O

EMC Directive (2014/30/EU)

Harmonized Standards: EN 61326-1:2013, EN 61326-2-3:2013

RoHS Directive (2011/65/EU)
Models 3051P, 2051G, 2088, and 2090 Pressure Transmitters
 Harmonized Standard: EN 50581:2012
 Does not apply to Low Power output option (feature code N)

ATEX Directive (2014/34/EU)



BAS00ATEX1166X - Intrinsic Safety Certificate
 Equipment Group II Category 1 G
 Ex ia IIC T4 Ga
 Harmonized Standards:
 EN60079-0:2012 + A11:2013, EN60079-11:2012

BAS00ATEX3167X - Type n Certificate
 Equipment Group II Category 3 G
 Ex nA IIC T5 Gc
 Harmonized Standards:
 EN60079-0:2012 + A11:2013, EN60079-15:2010

BAS01ATEX1427X - Dust Certificate
 Equipment Group II Category 1 D
 Ex t IIIC T30°C T30060°C Da
 Harmonized Standards:
 EN60079-0:2012 + A11:2013
 Other Standards:
 EN60079-31:2009
 (A review against EN60079-31:2014 which is harmonized, shows no significant changes relevant to this equipment so EN60079-31:2009 continues to represent "State of the Art".)

KEMA97ATEX2378X - Flameproof Certificate
 Equipment Group II Category 1/2 G
 Ex db IIC T6, T4 Ga/Gb
 Harmonized Standards:
 EN 60079-0:2012 + A11:2013, EN60079-1:2014, EN60079-26:2015

Page 2 of 3



EU Declaration of Conformity

No: RMD 1010 Rev. O

ATEX Notified Bodies

DEKRA (KEMA) [Notified Body Number: 0344]
Utrechtseweg 310, 6812 AR, Arnhem
P.O. Box 5183, 6802 ED, Arnhem
The Netherlands
Postbank 6794687

SGS FIMCO OY [Notified Body Number: 0598]
P.O. Box 30 (Sarkniementie 3)
00211 HELSINKI
Finland

ATEX Notified Body for Quality Assurance

SGS FIMCO OY [Notified Body Number: 0598]
P.O. Box 30 (Sarkniementie 3)
00211 HELSINKI
Finland

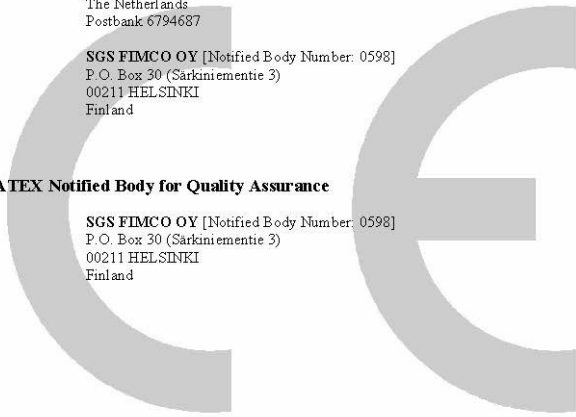

Page 3 of 3

10 China RoHS

Rosemount 2088

危害物质成分表
03031-9021, Rev AB

罗斯蒙特产品型号 2088
2/7/2020

含有China RoHS管控物质超过最大浓度限值的部件型号列表 2088
List of 2088 Parts with China RoHS Concentration above MCVs

部件名称 Part Name	有害物质 / Hazardous Substances					
	铅 Lead (Pb)	汞 Mercury (Hg)	镉 Cadmium (Cd)	六价铬 Hexavalent Chromium (Cr +6)	多溴联苯 Polybrominated biphenyls (PBB)	多溴联苯醚 Polybrominated diphenyl ethers (PBDE)
电子组件 Electronics Assembly	X	○	○	○	○	○
壳体组件 Housing Assembly	○	○	○	○	○	○
传感器组件 Sensor Assembly	○	○	○	○	○	○

本表格系依据SJ/T11364的规定而制作。

This table is proposed in accordance with the provision of SJ/T11364.

○: 意为该部件的所有均质材料中该有害物质的含量均低于GB/T 26572所规定的限量要求。

○: Indicate that said hazardous substance in all of the homogeneous materials for this part is below the limit requirement of GB/T 26572.

X: 意为在该部件所使用的所有均质材料里, 至少有一类均质材料中该有害物质的含量高于GB/T 26572所规定的限量要求。

X: Indicate that said hazardous substance contained in at least one of the homogeneous materials used for this part is above the limit requirement of GB/T 26572.

部件名称 Part Name	组装备件说明 Spare Parts Descriptions for Assemblies
电子组件 Electronics Assembly	电子线路板组件 Electronic Board Assemblies 端子块组件 Terminal Block Assemblies 升级套件 Upgrade Kits 液晶显示屏或本地操作界面 LCD or LOI Display
壳体组件 Housing Assembly	电子外壳 Electrical Housing
传感器组件 Sensor Assembly	传感器模块 Sensor Module

ROSEMOUNT



Rosemount 2090F

危害物质成分表
03031-9021, Rev AC

罗斯蒙特产品型号 **2090F**
2/10/2020

含有China RoHS管控物质超过最大浓度限值的部件型号列表 2090F
List of 2090F Parts with China RoHS Concentration above MCVs

部件名称 Part Name	有害物质 / Hazardous Substances					
	铅 Lead (Pb)	汞 Mercury (Hg)	镉 Cadmium (Cd)	六价铬 Hexavalent Chromium (Cr +6)	多溴联苯 Polybrominated biphenyls (PBB)	多溴联苯醚 Polybrominated diphenyl ethers (PBDE)
电子组件 Electronics Assembly	X	○	○	○	○	○
壳体组件 Housing Assembly	○	○	○	○	○	○
传感器组件 Sensor Assembly	○	○	○	○	○	○

本表格系依据SJ/T11364的规定而制作。

This table is proposed in accordance with the provision of SJ/T11364.

○: 意为该部件的所有均质材料中该有害物质的含量均低于GB/T 26572所规定的限量要求。

○: Indicate that said hazardous substance in all of the homogeneous materials for this part is below the limit requirement of GB/T 26572.

X: 意为在该部件所使用的的所有均质材料里, 至少有一类均质材料中该有害物质的含量高于GB/T 26572所规定的限量要求。

X: Indicate that said hazardous substance contained in at least one of the homogeneous materials used for this part is above the limit requirement of GB/T 26572.

部件名称 Part Name	组装备件说明 Spare Parts Descriptions for Assemblies
电子组件 Electronics Assembly	电子线路板组件 Electronic Board Assemblies 端子块组件 Terminal Block Assemblies 升级套件 Upgrade Kits 液晶显示屏或本地操作界面 LCD or LOI Display
壳体组件 Housing Assembly	电子外壳 Electrical Housing
传感器组件 Sensor Assembly	传感器模块 Sensor Module

ROSEMOUNT

EMERSON.

Rosemount 2090P

危害物质成分表
03031-9021, Rev AB

罗斯蒙特产品型号 **2090P**
2/1/2020

含有China RoHS 管控物质超过最大浓度限值的部件型号列表 2090P
List of 2090P Parts with China RoHS Concentration above MCVs

部件名称 Part Name	有害物质 / Hazardous Substances					
	铅 Lead (Pb)	汞 Mercury (Hg)	镉 Cadmium (Cd)	六价铬 Hexavalent Chromium (Cr +6)	多溴联苯 Polybrominated Diphenyls (PBB)	多溴联苯醚 Polybrominated diphenyl ethers (PBDE)
电子组件 Electronics Assembly	X	○	○	○	○	○
壳体组件 Housing Assembly	○	○	○	○	○	○
传感器组件 Sensor Assembly	○	○	○	○	○	○

本表格系依据SJ/T11364的规定而制作。
This table is proposed in accordance with the provision of SJ/T11364.

○: 意为该部件的所有均质材料中该有害物质的含量均低于GB/T 26572所规定的限量要求。
○: Indicate that said hazardous substance in all of the homogeneous materials for this part is below the limit requirement of GB/T 26572.

X: 意为该部件所使用的所有均质材料里, 至少有一类均质材料中该有害物质的含量高于GB/T 26572所规定的限量要求。
X: Indicate that said hazardous substance contained in at least one of the homogeneous materials used for this part is above the limit requirement of GB/T 26572.

部件名称 Part Name	组装备件说明 Spare Parts Descriptions for Assemblies
电子组件 Electronics Assembly	电子线路板组件 Electronic Board Assemblies 端子块组件 Terminal Block Assemblies 升级套件 Upgrade Kits 液晶显示屏或本地操作界面 LCD or LOI Display
壳体组件 Housing Assembly	电子外壳 Electrical Housing
传感器组件 Sensor Assembly	传感器模块 Sensor Module





Quick Start Guide
00825-0100-4108, Rev. GA
March 2022

©2022 Emerson. All rights reserved.

Emerson Terms and Conditions of Sale are available upon request. The Emerson logo is a trademark and service mark of Emerson Electric Co. Rosemount is a mark of one of the Emerson family of companies. All other marks are the property of their respective owners.

ROSEMOUNT™

