

# FCLi with 1056 Analyzer



## ESSENTIAL INSTRUCTIONS

### READ THIS PAGE BEFORE PROCEEDING!

Your purchase from Rosemount Analytical, Inc. has resulted in one of the finest instruments available for your particular application. These instruments have been designed, and tested to meet many national and international standards. Experience indicates that its performance is directly related to the quality of the installation and knowledge of the user in operating and maintaining the instrument. To ensure their continued operation to the design specifications, personnel should read this manual thoroughly before proceeding with installation, commissioning, operation, and maintenance of this instrument. If this equipment is used in a manner not specified by the manufacturer, the protection provided by it against hazards may be impaired.

- Failure to follow the proper instructions may cause any one of the following situations to occur: Loss of life; personal injury; property damage; damage to this instrument; and warranty invalidation.
- Ensure that you have received the correct model and options from your purchase order. Verify that this manual covers your model and options. If not, call 1-800-854-8257 or 949-757-8500 to request correct manual.
- For clarification of instructions, contact your Rosemount representative.
- Follow all warnings, cautions, and instructions marked on and supplied with the product.
- Use only qualified personnel to install, operate, update, program and maintain the product.
- Educate your personnel in the proper installation, operation, and maintenance of the product.
- Install equipment as specified in the Installation section of this manual. Follow appropriate local and national codes. Only connect the product to electrical and pressure sources specified in this manual.
- Use only factory documented components for repair. Tampering or unauthorized substitution of parts and procedures can affect the performance and cause unsafe operation of your process.
- All equipment doors must be closed and protective covers must be in place unless qualified personnel are performing maintenance.
- If this equipment is used in a manner not specified by the manufacturer, the protection provided by it against hazards may be impaired.

## WARNING RISK OF ELECTRICAL SHOCK

- Equipment protected throughout by double insulation.
- Installation of cable connections and servicing of this product require access to shock hazard voltage levels.
- Main power and relay contacts wired to separate power source must be disconnected before servicing.
- Do not operate or energize instrument with case open!
- Signal wiring connected in this box must be rated at least 240 V.
- Non-metallic cable strain reliefs do not provide grounding between conduit connections! Use grounding type bushings and jumper wires.
- Unused cable conduit entries must be securely sealed by non-flammable closures to provide enclosure integrity in compliance with personal safety and environmental protection requirements. Unused conduit openings must be sealed with NEMA 4X or IP65 conduit plugs to maintain the ingress protection rating (NEMA 4X).
- Electrical installation must be in accordance with the National Electrical Code (ANSI/NFPA-70) and/or any other applicable national or local codes.
- Operate only with front and rear panels fastened and in place over terminal area.
- Safety and performance require that this instrument be connected and properly grounded through a three-wire power source.
- Proper relay use and configuration is the responsibility of the user.

## CAUTION

This product generates, uses, and can radiate radio frequency energy and thus can cause radio communication interference. Improper installation, or operation, may increase such interference. As temporarily permitted by regulation, this unit has not been tested for compliance within the limits of Class A computing devices, pursuant to Subpart J of Part 15, of FCC Rules, which are designed to provide reasonable protection against such interference. Operation of this equipment in a residential area may cause interference, in which case the user at his own expense, will be required to take whatever measures may be required to correct the interference.

## WARNING

This product is not intended for use in the light industrial, residential or commercial environments per the instrument's certification to EN50081-2.

### Emerson Process Management

2400 Barranca Parkway  
Irvine, CA 92606 USA  
Tel: (949) 757-8500  
Fax: (949) 474-7250

<http://www.rosemountanalytical.com>

© Rosemount Analytical Inc. 2012



**EMERSON**  
Process Management

# QUICK START GUIDE

## FOR FCLi ANALYZER

1. Refer to Section 2.0 for installation instructions and Section 3.0 for wiring instructions.
2. Once connections are secured and verified, apply power to the analyzer.
3. When the analyzer is powered up for the first time, **Quick Start** screens appear. Using **Quick Start** is easy.
  - a. A backlit field shows the position of the cursor.
  - b. To move the cursor left or right, use the keys to the left or right of the ENTER key. To scroll up or down or to increase or decrease the value of a digit, use the keys above and below the ENTER key. Use the left and right keys to move the decimal point.
  - c. Press ENTER to store a setting. Press EXIT to leave without storing changes. Pressing EXIT also returns the display to the initial Quick Start screen.
  - d. A vertical black bar with a downward pointing arrow on the right side of the screen means there are more items to display. Continue scrolling down to display all the items. When you reach the bottom of the list, the arrow will point up.

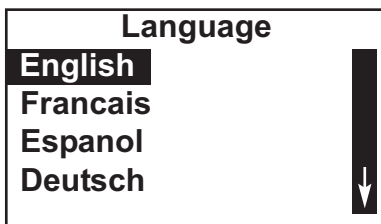

4. Choose the desired language. Scroll down to display more choices.

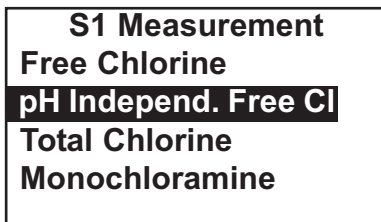

5. Choose pH-independent free chlorine for sensor 1 (**S1**).

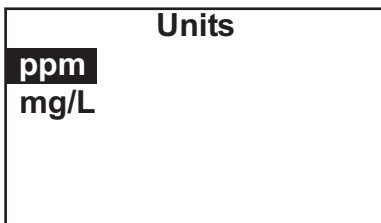

6. Choose the desired units for chlorine.

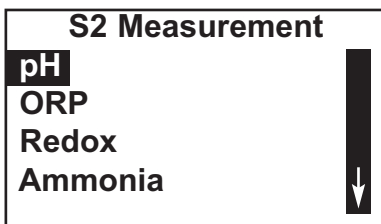

7. Choose pH for sensor 2 (**S2**). This screen appears only if you have an FCLi-02.

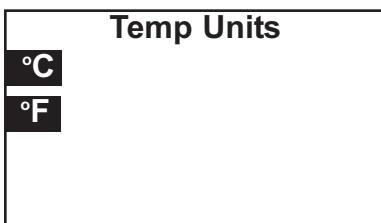

8. Choose the desired temperature units.

9. The main display appears. The outputs and alarms (if an alarm board is present) are assigned to default values.
10. To change outputs, alarms, and other settings go to the main menu and choose **Program**. Follow the prompts. A menu tree is on the following two pages. To calibrate the sensor(s) refer to section 6.0.

# MENU TREE

## Calibrate

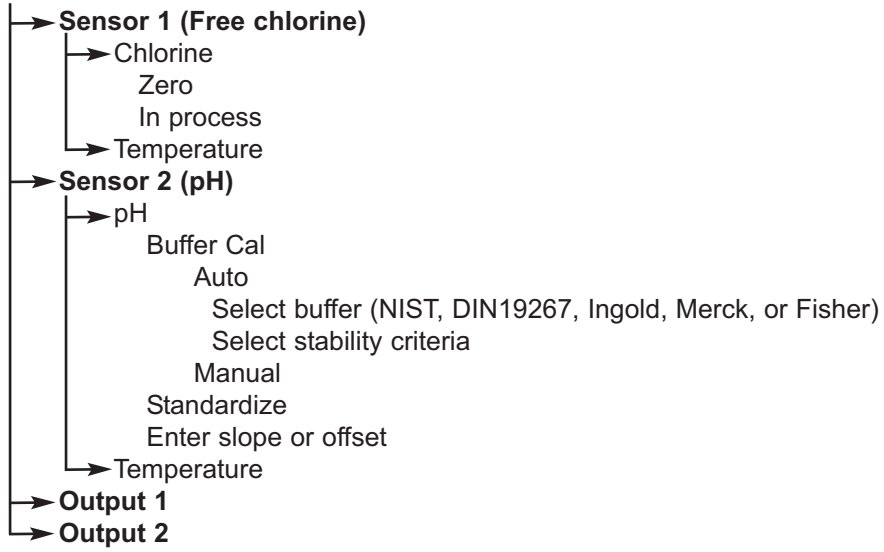

## Hold



## Display

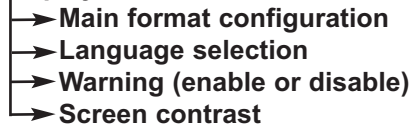

See next page for rest of menu tree

# MENU TREE (continued)

## Program

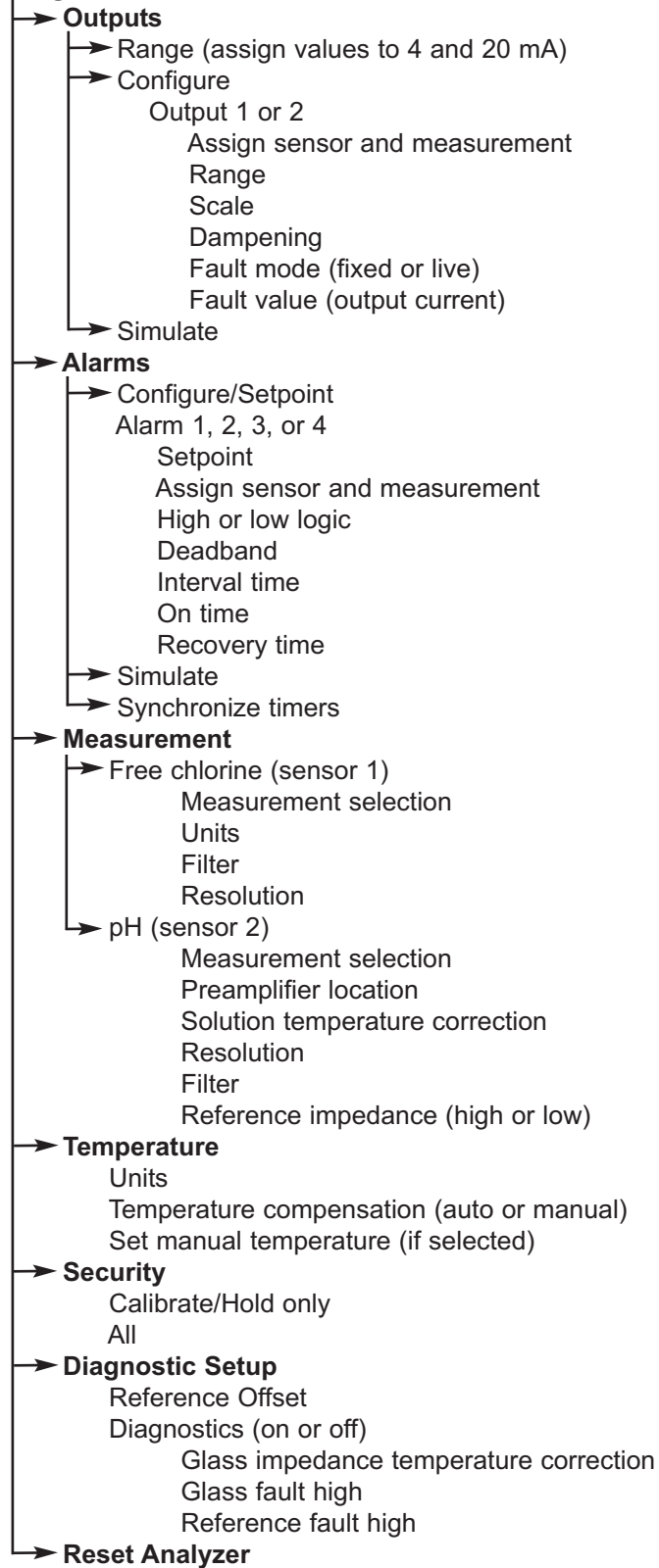

---

## About This Document

This manual contains instructions for installation and operation of the Model FCLi-1056

The following list provides notes concerning all revisions of this document.

<b><u>Rev. Level</u></b>	<b><u>Date</u></b>	<b><u>Notes</u></b>
A	1/08	This is the initial release of the product manual. The manual has been reformatted to reflect the Emerson documentation style and updated to reflect any changes in the product offering.
B	08/09	Update DNV / ISO Approval
C	5/11	Update specifications, part numbers, add information for new pH sensor 3900, added warning and wiring diagrams in sec 3, add electrical shock warning sec 8.0, modified instructions for cleaning the pH sensor and replacement parts tables sec 8
D	03/12	Update addresses - mail and web

# FCLi-1056

## TABLE OF CONTENTS

Section	Title	Page
<b>1.0</b>	<b>DESCRIPTION AND SPECIFICATIONS .....</b>	<b>1</b>
1.1	Applications and Features .....	1
1.2	Specifications .....	2
1.3	Ordering Information .....	3
<b>2.0</b>	<b>INSTALLATION .....</b>	<b>5</b>
2.1	Unpacking and Inspection.....	5
2.2	Installation.....	5
<b>3.0</b>	<b>WIRING.....</b>	<b>9</b>
3.1	Preparing Conduit Openings.....	9
3.2	Power, Alarm, Output, and Sensor Connections .....	10
<b>4.0</b>	<b>DISPLAY AND OPERATION .....</b>	<b>13</b>
4.1	Display .....	13
4.2	Keypad.....	14
4.3	Programming the Analyzer - Tutorial.....	15
4.4	Security .....	16
4.5	Using Hold .....	17
4.6	Configuring the Main Display .....	18
<b>5.0</b>	<b>PROGRAMMING THE ANALYZER .....</b>	<b>19</b>
5.1	General .....	19
5.2	Default Settings.....	19
5.3	Configuring, Ranging and Simulating Outputs.....	22
5.4	Configuring Alarms and Assigning Setpoints .....	25
5.5	Configuring the Measurement.....	30
5.6	Configuring Temperature Related Settings .....	32
5.7	Configuring Security Settings.....	33
5.8	Setting up Diagnostics .....	34
5.9	Resetting the Analyzer .....	36
<b>6.0</b>	<b>CALIBRATION .....</b>	<b>37</b>
6.1	Introduction .....	37
6.2	Calibrating Temperature.....	37
6.3	Calibration - Free Chlorine .....	39
6.4	Calibration - pH .....	42
6.5	Calibration - Analog Outputs .....	49

## TABLE OF CONTENTS CONT'D

Section	Title	Page
<b>7.0</b>	<b>DIGITAL COMMUNICATIONS .....</b>	<b>51</b>
<b>8.0</b>	<b>MAINTENANCE .....</b>	<b>53</b>
8.1	Analyzer .....	53
8.2	Chlorine Sensor .....	54
8.3	pH Sensor .....	56
8.4	Constant Head Flow Controller .....	56
<b>9.0</b>	<b>TROUBLESHOOTING .....</b>	<b>59</b>
9.1	Overview .....	59
9.2	Using the Diagnostic Feature.....	59
9.3	Troubleshooting When a Fault Message is Showing .....	60
9.4	Troubleshooting When a Warning Message is Showing.....	63
9.5	Troubleshooting When No Error Message is showing - Chlorine .....	64
9.6	Troubleshooting When No Error Message is showing - pH .....	67
9.7	Troubleshooting When No Error Message is showing - General .....	70
9.8	Simulating Inputs - Chlorine .....	70
9.9	Simulating Inputs - pH.....	70
9.10	Simulating Inputs Temperature .....	71

## LIST OF TABLES

Number	Title	Page
1.3	Ordering Information .....	3
1.3	Component Parts .....	3
1.3	Accessories .....	3
1.3	Spare Parts.....	3
3.2	Sensor Wiring.....	10
4.6	Configuring the Main Display .....	18
5.1	Default Settings .....	20
5.1	Default Settings cont .....	21
5.7	Configuring Security Settings .....	33
5.8.2	Procedure - Setting Up Diagnostics .....	35
6.4	Calibration - pH .....	42
8.1	Analyzer .....	53
8.2.3	Spare Parts .....	55
8-2	Replacement Parts for Constant Head Flow Controller Assembly (Model FCLi-01) .....	57
8-3	Replacement Parts for Constant Head Flow Controller Assembly (Model FCLi-02) .....	58
9.3	Troubleshooting When a Fault Message is Showing .....	60
9.4	Troubleshooting When a Warning Message is Showing .....	63
9.5	Troubleshooting When No Error Message is Showing - Chlorine .....	64
9.6	Troubleshooting When No Error Message is Showing - pH.....	67

**LIST OF TABLES CONT'D**

9.6.1	Calibration Error During Two-Point Calibration .....	67
9.7	Troubleshooting When No Error Message is Showing - General.....	70
9.9.2	Simulating pH Input .....	70
9.10	Simulating Inputs Temperature.....	72

**LIST OF FIGURES**

<b>Number</b>	<b>Title</b>	<b>Page</b>
2-1	Chlorine Sensor Parts .....	7
2-2	Model FCLi-01.....	8
2-3	Model FCLi-02.....	8
3-1	Analog Output Connections .....	9
3-2	Alarm Relay Connections.....	10
3-3	Wiring Diagram for Free Chlorine Sensor .....	11
3-4	Wiring Diagram for 399VP-09 pH Sensor .....	11
3-5	Wiring Diagram for 3900VP-10 pH sensor (gray cable).....	11
3-6	Wiring Diagram for 3900VP-10 pH sensor (blue cable).....	11
4-1	Main Display.....	13
4-2	Programming Screen Showing Item List.....	13
4-3	Arrow Bar .....	13
4-4	Analyzer Keypad .....	14
4.5	Navigation Keys .....	14
5-1	High Alarm Logic .....	26
5-2	Low Alarm Logic .....	26
5-3	Operation of the Interval Timer.....	26
6-1	Sensor Current as a Function of Free Chlorine Concentration .....	39
6-2	Calibration Slope and Offset .....	42
8-1	Chlorine Sensor Parts .....	55
8-2	Replacement Parts for the Flow Controller Assembly used in Model FCLi-01.....	57
8-3	Replacement Parts for the Flow Controller Assembly used in Model FCLi-02.....	58
9-1	Pin Out Diagram for Model 498CL-01-VP Sensor .....	61
9-2	Pin Out Diagram for Model 399VP-09 Sensor .....	61
9-3	Simulating pH Inputs .....	70
9-4	Three-Wire RTD Configuration.....	71
9-5	Simulating TRD Inputs.....	71

THIS PAGE LEFT BLANK INTENTIONALLY

## SECTION 1.0. DESCRIPTION AND SPECIFICATIONS

- COMPLETE SYSTEM INCLUDES sensor, connecting cable, analyzer, and flow controller
- SENSOR RESPONSE IS PRACTICALLY INDEPENDENT of pH between pH 6 and 10
- NO REAGENTS
- NO AUXILIARY pH ELECTRODE
- VARIOPOL QUICK-DISCONNECT FITTINGS makes sensor replacement easy

### 1.1 APPLICATIONS AND FEATURES

The FCL*i* free chlorine system is intended for the determination of free chlorine (hypochlorous acid plus hypochlorite ion) in fresh water. Unlike other free chlorine analyzers, the FCL*i* does not use expensive sample conditioning systems or messy reagents to control pH. Nor, does it require an auxiliary pH sensor for pH correction. Instead, the pH adjustment takes place inside the sensor, producing a signal that changes less than 4% per unit change in pH between pH 6 and 10. Below pH 6.5 the change is less than 1%. The linear range of the sensor is 0 to 20 ppm (mg/L).

The FCL*i* is not intended for the determination of total or combined chlorine (like monochloramine). Nor, can the FCL*i* be used for the determination of chlorine in seawater.

The FCL*i* uses a three electrode, membrane-covered amperometric sensor. The sensor consists of a hydrophilic membrane stretched over a gold mesh cathode. A silver/silver chloride reference electrode and an external copper auxiliary electrode complete the circuit. The fill solution is saturated succinic acid slurry. During operation, an electrochemical reaction, driven by the polarizing voltage, consumes free chlorine at the cathode surface. The auxiliary electrode provides the electrons for the cathode reaction, and a current proportional to the reaction rate flows between the electrodes. Because the concentration of chlorine at the cathode is zero, free chlorine in the sample continuously diffuses through the membrane and is destroyed at the cathode. Thus, the cathode current is proportional to the diffusion rate, which is proportional to the concentration of free chlorine in the sample.

The FCL*i* sensor requires neither sample pretreatment nor pH correction. All amperometric free chlorine sensors generate a raw current that depends primarily on the concentration of hypochlorous acid. Because the

fraction of free chlorine present as hypochlorous acid is a function of pH, readings will be in error if the sample pH changes from the value it had during calibration. To correct for pH changes, some manufacturers treat the sample with acid to convert hypochlorite to hypochlorous acid. Others continuously measure the pH and use the pH value to correct the chlorine sensor reading. The Model FCL*i* is different. The sensor uses a highly buffered acidic fill solution for internal pH adjustment. The fill solution converts all the free chlorine entering the sensor as well as much of the free chlorine at the outside surface of the membrane into hypochlorous acid. Thus, the sensor response is practically independent of pH.

For customers who wish to measure pH, an option that includes a pH sensor and flow cell is available.

Maintenance is fast and easy. Replacing a membrane requires no special tools or fixtures. A screw cap holds the pre-tensioned membrane in place. Replacing the membrane and fill slurry takes only a few minutes.

The FCL*i* includes the easy-to-use Model 1056 analyzer. The analyzer features two fully programmable 4-20 mA analog outputs. Programming and calibration is simple and intuitive. The backlit, four-line display allows the user to read chlorine (and pH) at a single glance.

Valves, rotameters, and pressure regulators to control sample flow are things of the past with the Model FCL*i*. A constant head overflow sampler ensures the correct flow to the sensor no matter how much the sample flow or pressure changes. To eliminate wiring hassles, quick disconnect Variopol cable is standard.

Stable free chlorine standards do not exist. The chlorine sensor must be calibrated using the results of a laboratory test run on a grab sample.

**1.2 SPECIFICATIONS — GENERAL****Sample requirements:**

Pressure: 3 to 65 psig (122 to 549 kPa abs)

A check valve in the inlet opens at 3 psig (122 kPa abs). If the check valve is removed, minimum pressure is 1 psig (108 kPa abs).

Temperature: 32 to 122°F (0 to 50°)

Minimum Flow: 2 gal/hr (7.6 L/hr)

Maximum flow: 80 gal/hr (303 L/hr); high flow causes the overflow tube to back up.

**Sample Conductivity:** >10 µS/cm

**Process connection:** 1/4-in OD tubing compression fitting (can be removed and replaced with barbed fitting for soft tubing).

**Drain connection:** 3/4-in barbed fitting. Sample must drain to open atmosphere.

**Wetted parts:**

Overflow sampler: acrylic, polycarbonate, polyester, Kynar<sup>1</sup>, nylon, silicone

Chlorine sensor: PVC, Viton<sup>2</sup>, silicone, polyether-sulfone, polyester, gold, and copper (or 316 stainless steel)

pH sensor (3900VP) : Stainless steel, glass, Teflon<sup>®2</sup>, polyphenylene sulfide, EPDM, and silicone

**Response time to step change in chlorine concentration:** <120 sec to 90% of final reading for inlet sample flow of 2 gph (7.6 L/hr).

**Weight/shipping weight:**

Model FCLi-01: 10 lb/13 lb (4.5 kg/6.0 kg)

Model FCLi-02: 11 lb/14 lb (5.0 kg/6.5 kg)

[rounded to the nearest 1 lb. (0.5 kg)]

**SPECIFICATIONS — SENSOR**

**Free chlorine range:** 0 to 20 ppm as Cl<sub>2</sub>. For higher ranges, consult the factory.

**Accuracy:** Accuracy depends on the accuracy of the chemical test used to calibrate the sensor

**Linearity (0-20 ppm):** 1% per IEC 60746

**Linearity (0-2 ppm):** ±0.05 ppm following calibration at 2 ppm

**Sensitivity to pH:** Between pH 6.5 and 10, sensor signal changes <4% per unit change in pH. Below pH 6.5 the change is <1% per unit change in pH.

**Interferences:** Monochloramine, dichloramine, permanganate, and peroxides

**Electrolyte life:** 3 months (approx.)

**SPECIFICATIONS — ANALYZER**

**Case:** Polycarbonate, NEMA 4X/CSA4 (IP65)

**Display:** Monochromatic back-lit LCD. Main character height 0.6 in (15 mm). Display is user-programable.

**Languages:** English, German, Italian, Spanish, French, Portuguese

**Ambient temperature and humidity:** 32 to 131°F (0 to 55°C); RH 5 to 95% (con-condensing)

**Storage temperature:** -4 to 140°F (-20°C and 60°C)

**Power:** 85 to 265 Vac, 47.5-65.0 Hz, 15 W.

Equipment protected by double insulation.

**RFI/EMI:** EN-61326

**LVD:** EN-61010-1



**Outputs:** Two 4-20 mA or 0-20 mA isolated outputs. Continuously adjustable. Linear or logarithmic. Maximum load 550 ohms. Output dampening with time constant of 5 sec is user-selectable.

**Alarms:** Four alarm relays for process measurement(s) or temperature. Any relay can be configured as a fault alarm instead of a process alarm. Each relay can be configured independently and each can be programmed with interval timer settings.

**Relays:** Form C, SPDT, epoxy sealed

**Relay Contact ratings:**

5 A at 28 VDC or 300 VAC (resistive)  
1/8 HP at 120/240 VAC.

**Terminal Connections Rating:** Power connector (3-leads): 18-12 AWG wire size. Current output connectors (2-leads): 24-16 AWG wire size. Alarm relay terminal blocks: 18-16 AWG wire size

<sup>1</sup> Kynar is a registered trademark of Elf Atochem North America.

<sup>2</sup> Viton and Teflon are registered trademarks of DuPont Performance Eastomers.

### 1.3 ORDERING INFORMATION

**FCLi Free Chlorine Measuring System.** The FCLi is a complete system for the determination of free chlorine in aqueous samples. It consists of the sensor(s), analyzer, and constant head flow controller. All components are mounted on a backplate. Model option -02 includes a pH sensor for customers who wish to measure pH in addition to free chlorine. Three replacement membranes and enough electrolyte chemicals to fill the sensor three times are shipped with each sensor.

<b>FCLi FREE CHLORINE MEASURING SYSTEM</b>	
<b>CODE</b>	<b>pH CORRECTION (required selection)</b>
01	Without pH sensor
02	With pH sensor
<b>CODE</b>	<b>pH CORRECTION (required selection)</b>
220	1056-03-24-38-AN, 115/230 Vac 50/60 Hz, alarm relays, analog outputs, chlorine only (option -01 only)
221	1056-03-24-32-AN, 115/230 Vac 50/60 Hz, alarm relays, analog outputs, chlorine and pH (option -02 only)
<b>FCLi-02 -221 EXAMPLE</b>	

### COMPONENT PARTS

<b>ANALYZER MODEL</b>	<b>DESCRIPTION</b>
1056-03-24-38-AN	1056-03-24-38-AN, 115/230 Vac 50/60 Hz, alarm relays, analog outputs, chlorine only
1056-03-24-32-AN	1056-03-24-32-AN, 115/230 Vac 50/60 Hz, alarm relays, analog outputs, chlorine and pH
<b>SENSOR MODEL</b>	<b>DESCRIPTION</b>
498CL-01-VP	pH-independent free chlorine sensor with Variopol connector
3900VP-02-10	pH sensor with Variopol connector
<b>SENSOR CABLE</b>	<b>DESCRIPTION</b>
24150-00	Interconnecting cable, Variopol for 498ACL sensor, 4 ft
23645-08	Interconnecting cable, Variopol for 3900VP sensor (gray), 4 ft
24281-05	Interconnecting cable, Variopol for 3900VP sensor (blue), 4 ft

### ACCESSORIES

<b>PART #</b>	<b>DESCRIPTION</b>
9240048-00	Tag, stainless steel (specify marking)

### SPARE PARTS

<b>PART #</b>	<b>DESCRIPTION</b>
33970-00	Fill plug
33968-00	Membrane retainer
9550094	O-ring, 2-014, Viton®
23501-10	pH-independent free chlorine membrane assembly, includes one membrane assembly and O-ring
23502-10	pH-independent free chlorine membrane assembly, includes three membrane assemblies and three O-rings
24146-00	pH-independent free chlorine sensor electrolyte kit, includes three bottles of saturated succinic acid and three bottles of succinic acid crystals



## SECTION 2.0. INSTALLATION

### 2.1 UNPACKING AND INSPECTION

Inspect the shipping container. If it is damaged, contact the shipper immediately for instructions. Save the box. If there is no apparent damage, unpack the container. Be sure all items shown on the packing list are present. If items are missing, notify Rosemount Analytical immediately.

#### 2.1.1 MODEL FCLi-01-220 (free chlorine without pH sensor)

Model consists of the following items mounted on a back plate.

1. Model 1056-03-24-38-AN analyzer with sensor cable attached.
2. Constant head overflow sampler with flow cell for chlorine sensor.

The free chlorine sensor (Model 498CL-01-VP) is in a separate package. The sensor is shipped with three membrane assemblies and enough electrolyte chemicals to fill the sensor three times.

#### 2.1.1 MODEL FCLi-02-221 (free chlorine with pH sensor)

Model consists of the following items mounted on a back plate.

1. Model 1056-03-24-32-AN analyzer with sensor cables attached.
2. Constant head overflow sampler with flow cells for chlorine and pH sensors.
3. Stand to hold buffer solution during calibration.

The free chlorine sensor (Model 498CL-01-VP) and the Model 3900VP-02-10 pH sensor, which replaces the older Model 399VP-09 sensor, are in separate packages. The free chlorine sensor is shipped with three membrane assemblies and enough electrolyte chemicals to fill the sensor three times.

## 2.2 INSTALLATION

### 2.2.1 General Information

1. Although the system is suitable for outdoor use, do not install it in direct sunlight or in areas of extreme temperature.



2. To keep the analyzer enclosure watertight, install plugs (provided) in the unused cable openings.
3. Install the system in an area where vibrations and electromagnetic and radio frequency interference are minimized or absent.
4. Be sure there is easy access to the analyzer and sensors.

### 2.2.2 Sample Requirements

Be sure the sample meets the following requirements:

1. Temperature: 32 to 122°F (0 to 50°C)
2. Pressure: 3 to 65 psig (122 to 549 kPa abs)
3. Minimum flow: 2 gal/hr (7.6 L/hr)

### 2.2.3 Mounting and Making Inlet and Drain Connections

The FCLi is intended for wall mounting only. Refer to Figure 2-2 or 2-3 for details.

A 1/4-inch OD tubing compression fitting is provided for the sample inlet. If desired, the compression fitting can be removed and replaced with a barbed fitting. Do not remove the check valve. The threads are 1/4-inch FNPT.

The sample drains through a 3/4-inch barbed fitting. Attach a piece of soft tubing to the fitting and allow the waste to drain to open atmosphere. **Do not restrict the drain line.**

Adjust the sample flow until the water level is even with the central overflow tube and excess water is flowing down the tube. Confirm that sample is flowing through the flow cells.

### 2.2.4 Electrical Connections

Refer to Section 3.1 for details.

### 2.2.5 Installing the Sensor(s)

1. **The chlorine sensor leaves the factory with a shipping membrane in place. The shipping membrane must be removed and replaced with the chlorine membrane before putting the sensor in service. The chlorine membrane is in a plastic bag attached to the sensor. Do not remove the shipping membrane until you are ready to put the sensor in service.**
  - a. Remove the red protective cap from the end of the sensor.
  - b. Holding the membrane end pointing up (cable connector end pointing down), unscrew the retainer cap and remove the shipping membrane. See Figure 2.1. It is not necessary to remove the O-ring. **Save the shipping membrane.** It should be reinstalled on the sensor when the sensor is not in use.
  - c. Still holding the membrane end pointing up, install the chlorine membrane. The chlorine membrane is in the plastic bag attached to the sensor. Screw the retainer back in place.

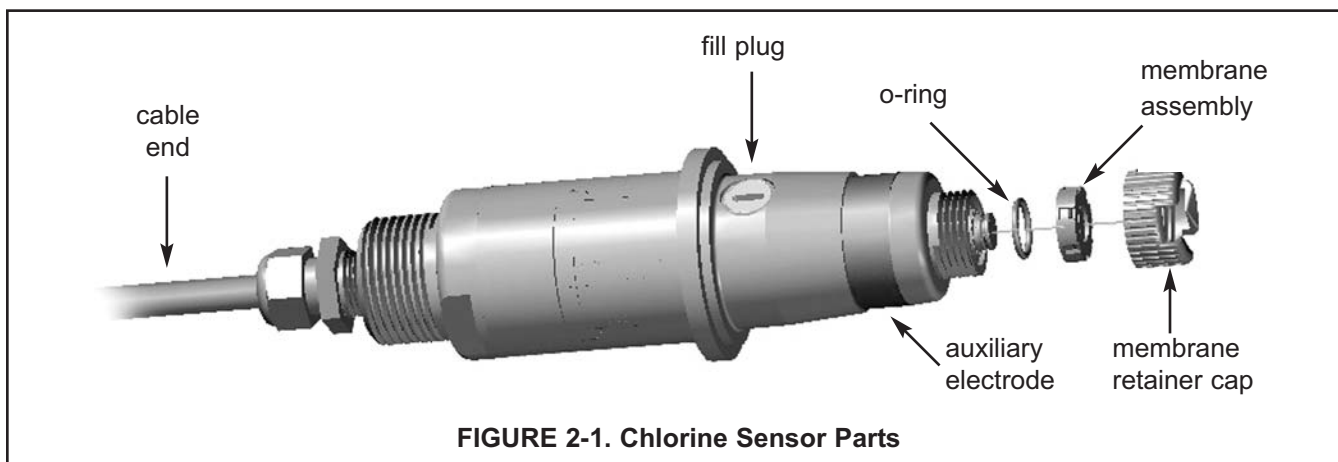

2. If you are using a pH sensor, remove the protective cap on the sensor.
3. Install the sensors in the flow cells as shown in Figures 2.2 and 2.3. For Model FCLi-02-221, the pH sensor must be installed as shown in Figure 2.3. The chlorine sensor sits in the flow cell and is held in place by the union nut. The pH sensor screws into a plastic fitting, which the union nut holds in the flow cell. Be sure to slip the union nut over the sensor before connecting the cable to the sensor.
4. The Model FCLi is provided with sensor cables pre-wired to the analyzer. Connect the chlorine sensor to the cable labeled Chlorine Sensor. Connect the pH sensor to the cable labeled pH Sensor. The terminal end of the sensor is keyed to ensure proper mating with the cable receptacle. Once the key has slid into the mating slot, tighten the connection by turning the knurled ring clockwise.

#### NOTE

The chlorine sensor is available in two styles. One has a copper auxiliary electrode; the other has a stainless steel auxiliary electrode. The auxiliary electrode is the metal band visible at the bottom of the sensor. The copper electrode is gradually being phased out and replaced by a stainless steel electrode.

*If the sensor has a copper electrode...* Generally, it is best to keep the sensor in a continuously flowing sample. The sensor can tolerate loss of sample flow for about four days as long as it remains immersed in water in the flow cell. A check valve in the sample inlet prevents water from draining out of the flow cell. If the sensor sits too long in a stagnant sample, copper ions from the air oxidation of the electrode can diffuse into the sensor. Once inside the sensor, the copper undergoes an electrochemical reaction that greatly increases the background current and can potentially damage the sensor. See step 2 in Section 6.3.2 for more information.

*If the sensor has a stainless steel electrode...* The stainless steel electrode is not susceptible to air oxidation. Therefore, loss of sample flow does not normally present a problem.

Do not expose the chlorine sensor to air for any longer than an hour. Prolonged exposure to air will cause the membrane to dry out. Once this happens, the membrane must be replaced.

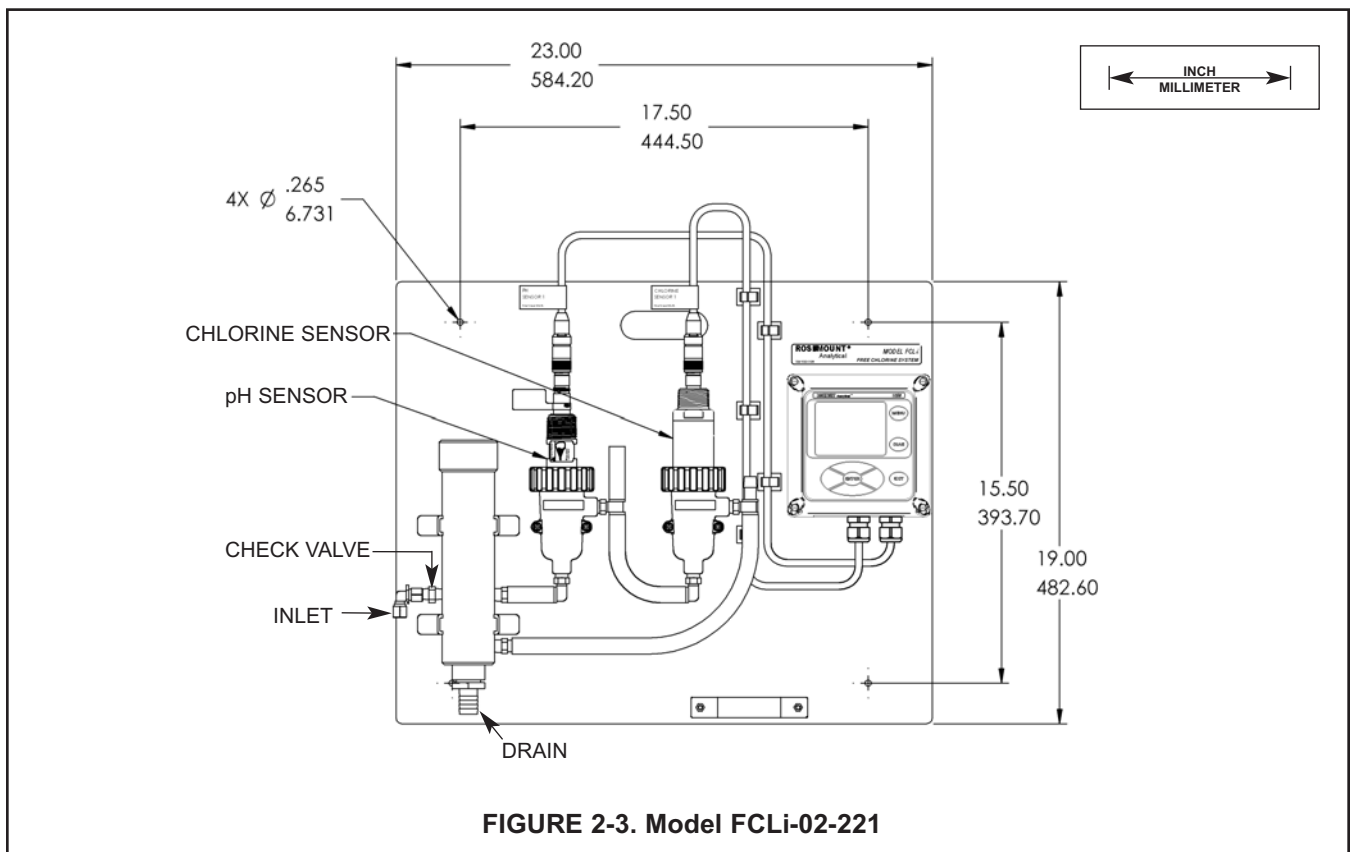
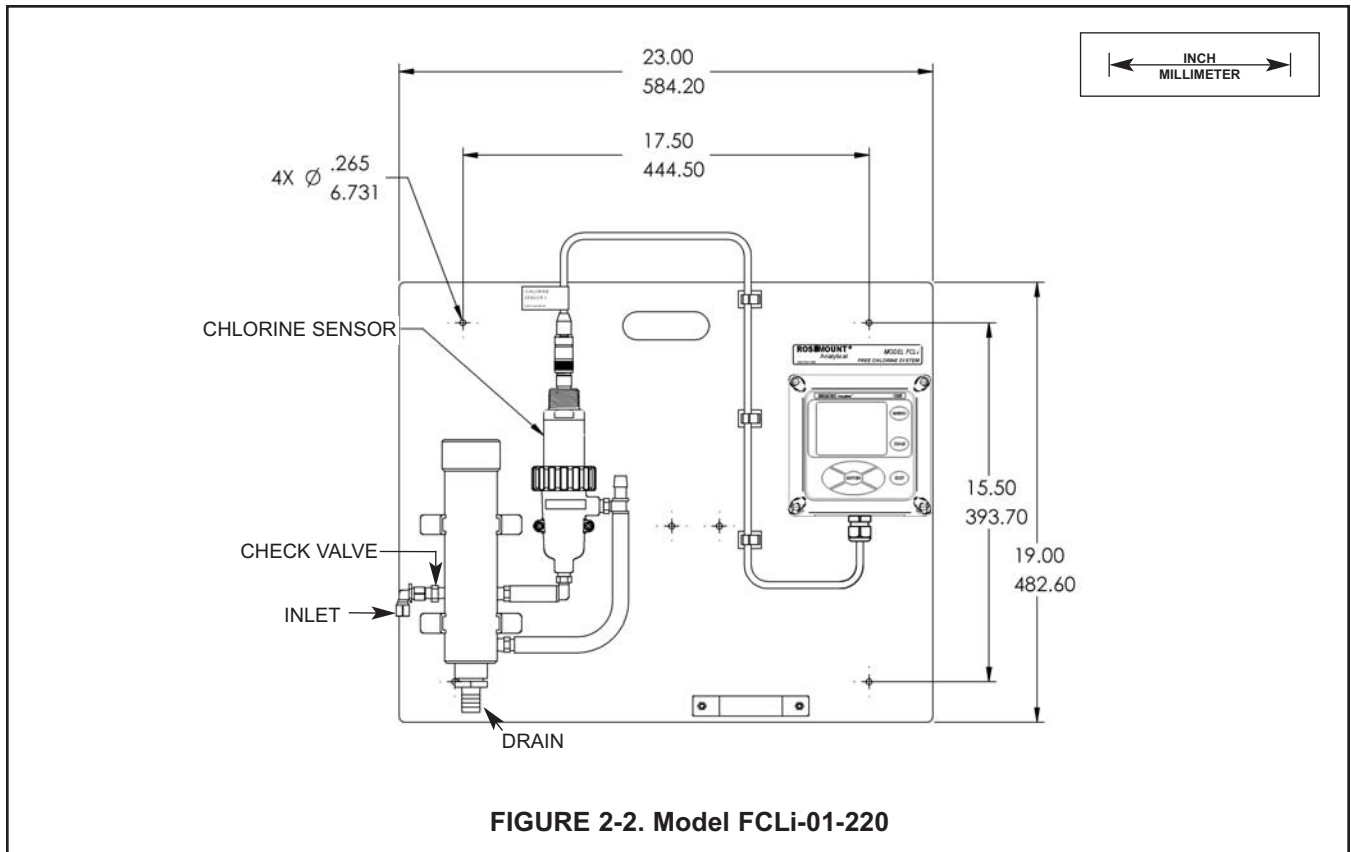

## SECTION 3.0.

### WIRING

#### 3.1 POWER, ALARM, AND OUTPUT WIRING

	<p><b>WARNING</b> RISK OF ELECTRICAL SHOCK</p>
<p>Electrical installation must be in accordance with the National Electrical Code (ANSI/NFPA-70) and/or any other applicable national or local code.</p>	

##### 3.1.1 Power

Wire AC mains power to the power supply board, which is mounted vertically on the left hand side of the analyzer enclosure. The power connector is at the top of the board. Unplug the connector from the board and wire the power cable to it. Lead connections are marked on the connector. (L is live or hot; N is neutral, the ground connection has the standard symbol.)

AC power wiring should be 14 gauge or greater. Run the power wiring through the conduit opening nearest the power terminal. Provide a switch or breaker to disconnect the analyzer from the main power supply. Install the switch or breaker near the analyzer and label it as the disconnecting device for the analyzer.

##### 3.1.2 Analog output wiring

Two analog current outputs are located on the main circuit board, which is attached to the inside of the enclosure door. Figure 3-1 shows the location of the terminals. The connectors can be detached for wiring. TB-1 is output 1. TB-2 is output 2. Polarity is marked on the circuit board.

For best EMI/RFI protection, use shielded output signal cable enclosed in earth-grounded metal conduit.

Keep output signal wiring separate from power wiring. Do not run signal and power or relay wiring in the same conduit or close together in a cable tray.

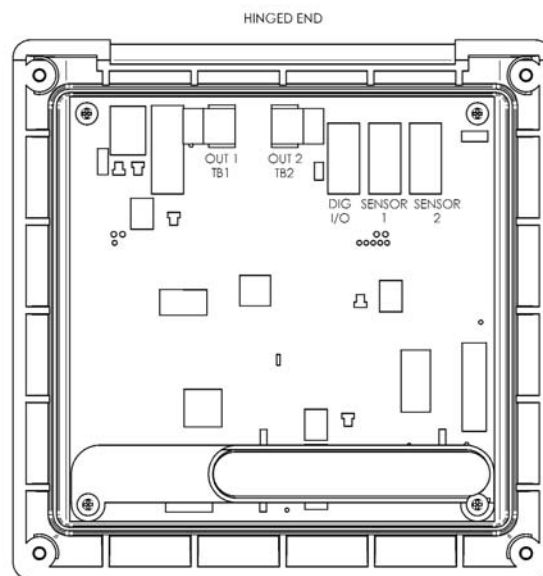

**FIGURE 3-1. Analog output connections.** The analog outputs are on the main board near the hinged end of the enclosure door.

3.1.3 Alarm wiring.

<b>⚠ WARNING</b>
Exposure to some chemicals may degrade the sealing properties used in the following devices: Zettler Relays (K1-K4) PN AZ8-1CH12DSEA

The alarm relay terminal strip is located just below the power connector on the power supply board. See Figure 3-2.

Keep alarm relay wiring separate from signal wiring. Do not run signal and power or relay wiring in the same conduit or close together in a cable tray.

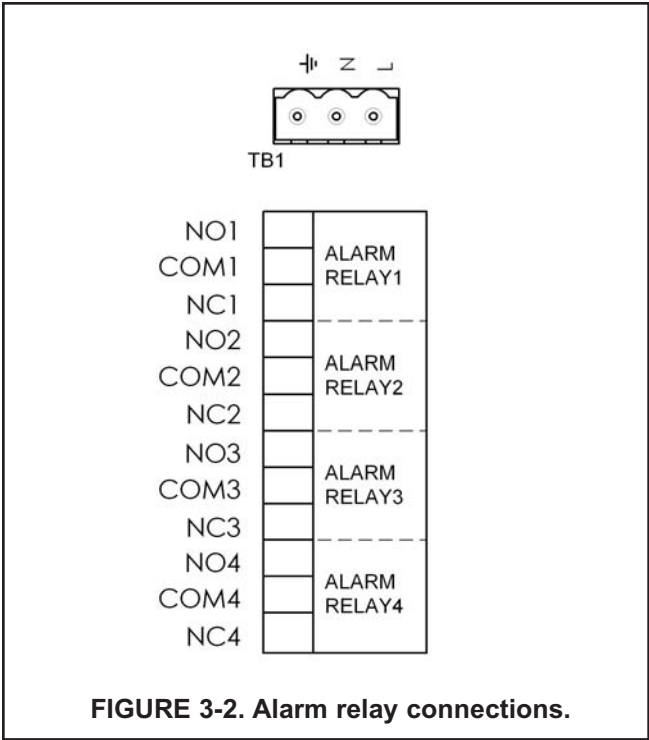

3.2 SENSOR WIRING

The Model FCLi is provided with sensor cables pre-wired to the analyzer. If it is necessary to replace the sensor cable, refer to the instructions below.

1. Shut off power to the analyzer.
2. Loosen the four screws holding the front panel in place and let it drop down.
3. Locate the appropriate signal board.

Slot 1 (left)	Slot 2 (center)	Slot 3 (right)
communication	input 1 (chlorine)	input 2 (pH)

4. Loosen the gland fitting and carefully push the sensor cable up through the fitting as you pull the board forward to gain access to the wires and terminal screws. Disconnect the wires and remove the cable.
5. Insert the new cable through the gland and pull the cable through the cable slot.
6. Wire the sensor to the signal board. Refer to the wiring diagrams in Figures 3-3 and 3-4.
7. Once the cable has been connected to the board, slide the board fully into the enclosure while taking up the excess cable through the cable gland. Tighten the gland nut to secure the cable and ensure a sealed enclosure.

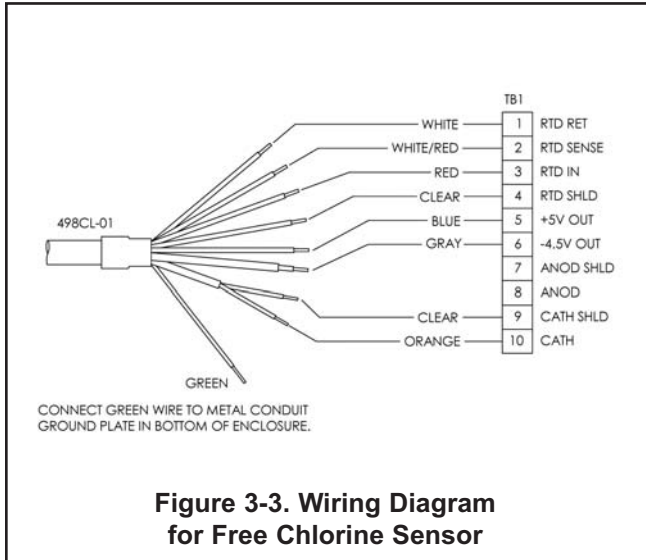

**Figure 3-3. Wiring Diagram for Free Chlorine Sensor**

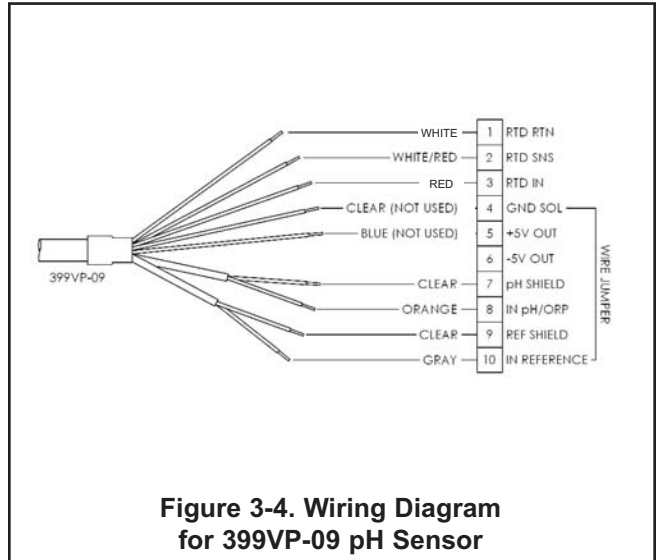

**Figure 3-4. Wiring Diagram for 399VP-09 pH Sensor**

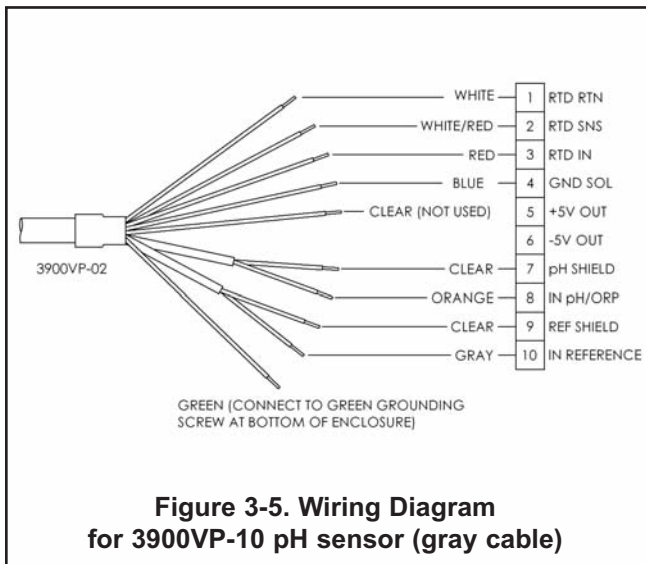

**Figure 3-5. Wiring Diagram for 3900VP-10 pH sensor (gray cable)**

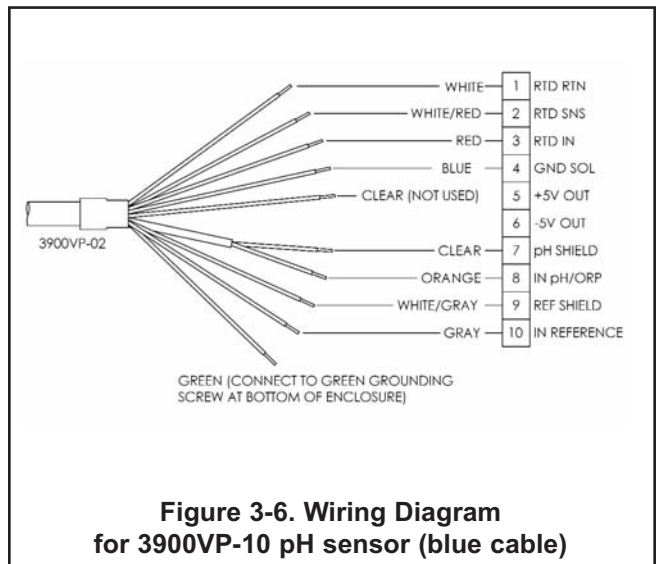

**Figure 3-6. Wiring Diagram for 3900VP-10 pH sensor (blue cable)**



# SECTION 4.0 DISPLAY AND OPERATION

## 4.1. DISPLAY

The analyzer has a four line display. See Figure 4-1. The display can be customized to meet user requirements. Refer to section 4.6.

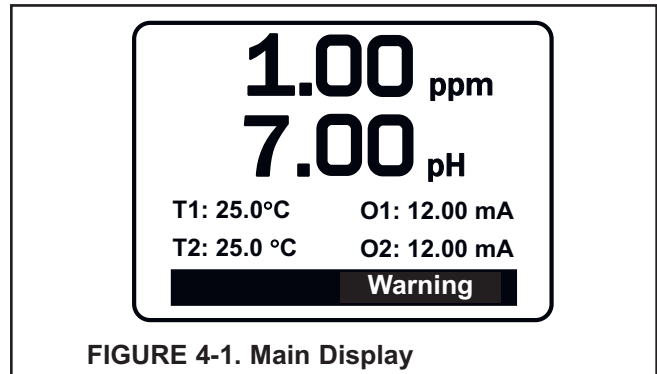

FIGURE 4-1. Main Display

When the analyzer is being programmed or calibrated, the display changes to a screen similar to the one shown in Figure 4-2. The live readings appear in small font at the top of the screen. The rest of the display shows programming and calibration information. Programming items appear in lists. The screen can show only four items at a time, and the arrow bar at the right of the screen indicates whether there are additional items in the list. See Figure 4.3 for an explanation of the arrow bar.

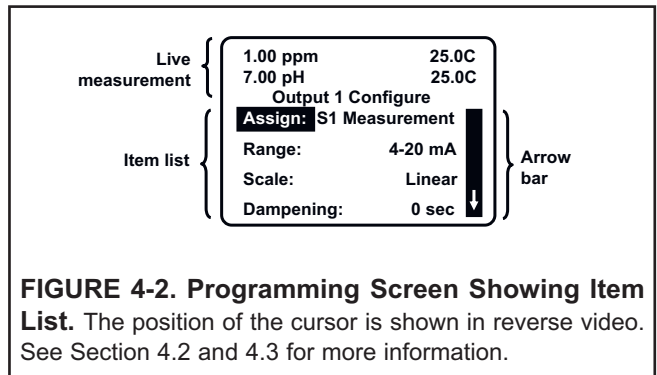

FIGURE 4-2. Programming Screen Showing Item List. The position of the cursor is shown in reverse video. See Section 4.2 and 4.3 for more information.

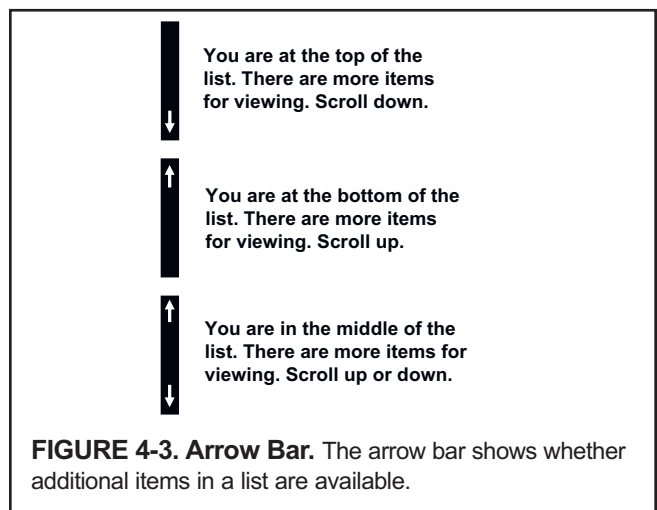
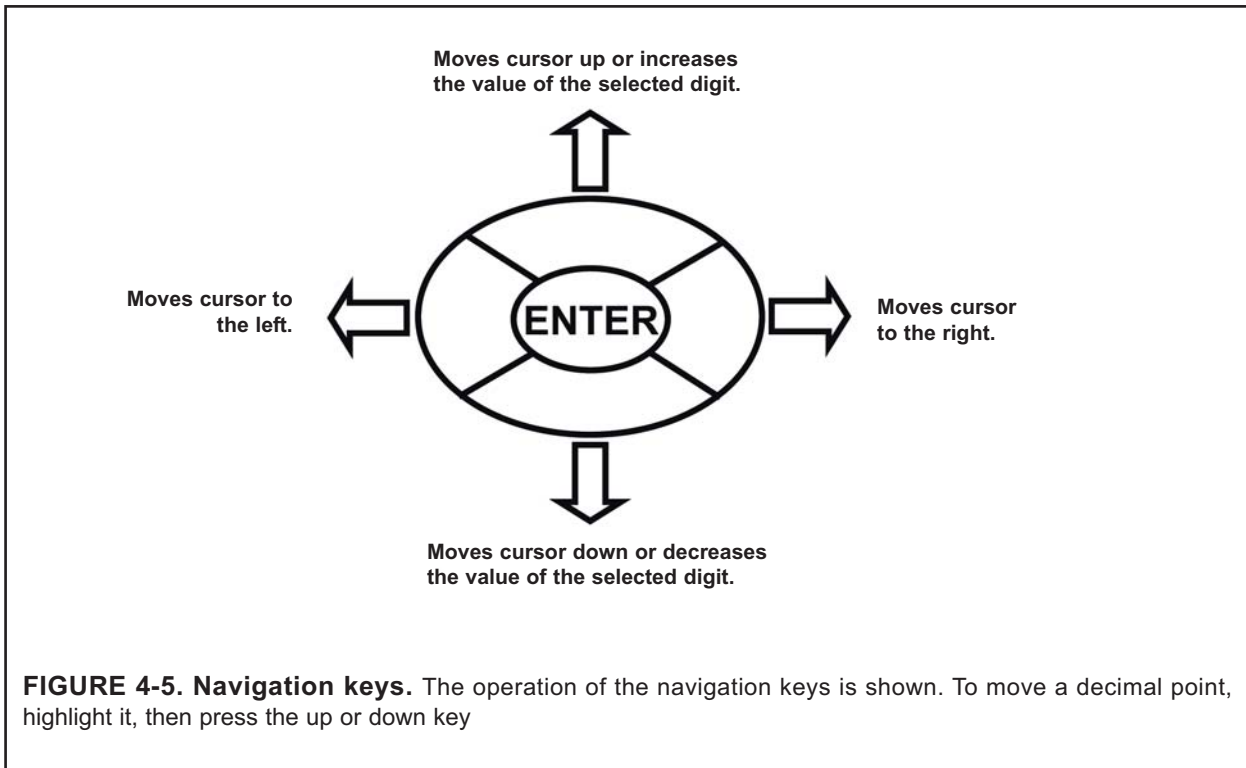
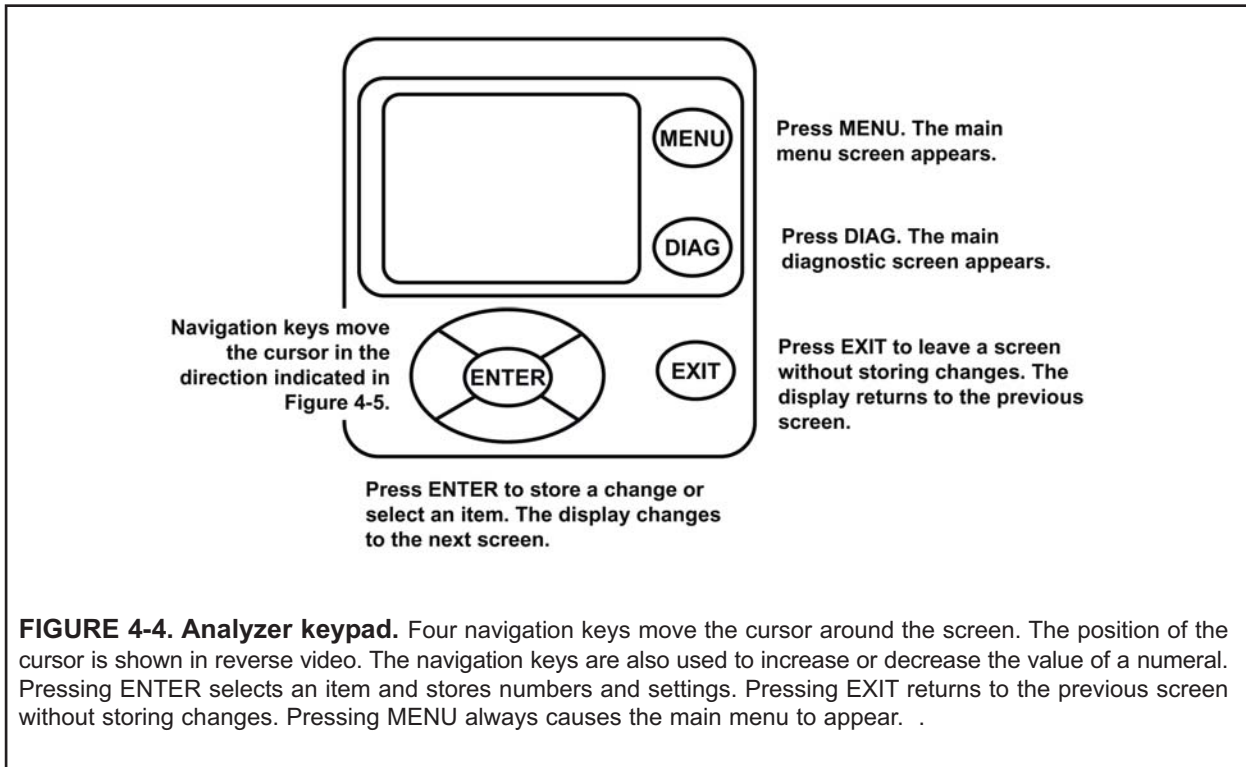

FIGURE 4-3. Arrow Bar. The arrow bar shows whether additional items in a list are available.

### 4.2 KEYPAD

Local communication with the analyzer is through the membrane keypad. Figures 4-4 and 4-5 explain the operation of the keys.



### 4.3 PROGRAMMING THE ANALYZER—TUTORIAL

Setting up and calibrating the analyzer is easy. The following tutorial describes how to move around in the programming menus. For practice, the tutorial also describes how to assign ppm chlorine values to the 4 and 20 mA analog outputs.

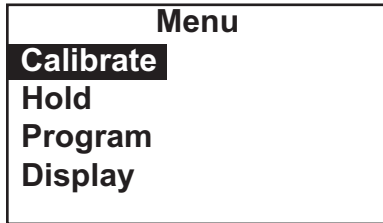

1. Press MENU. The main menu screen appears. There are four items in the main menu. **Calibrate** is in reverse video, meaning that the cursor is on Calibrate.

2. To assign values to the analog outputs, the **Program** sub-menu must be open. Use the down navigation key to move the cursor to **Program**. Press ENTER.

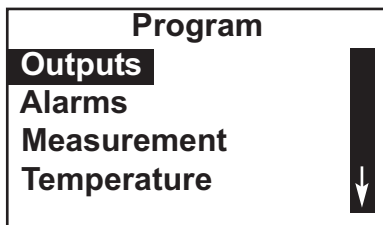

3. The Program menu appears. There are between five and seven items in the Program menu. Alarms appears only if the analyzer contains the optional alarm relay board. Diagnostic Setup appears only if you have the FCLi-02 with pH sensor. The screen displays four items at a time. The downward pointing arrow on the right of the screen shows there are more items available in the menu. To view the other items, use the down key to scroll to the last item shown and continue scrolling down. When you have reached the bottom, the arrow will point up. Move the cursor back to **Outputs** and press ENTER.

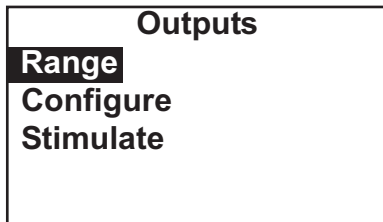

4. The screen at left appears. The cursor is on **Range**. **Output Range** is used to assign values to the low and high current outputs. Press ENTER.

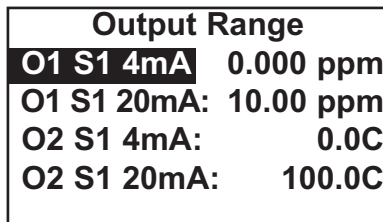

5. The screen at left appears. The screen shows the present values assigned to output 1 (**O1**) and output 2 (**O2**). The screen also shows which sensors the outputs are assigned to. **S1** is sensor 1 and **S2** is sensor 2. The assignments shown are the defaults for the FCLi-01. For the FCLi-02, Output 2 is assigned to sensor 2 (pH). Outputs are freely assignable under the configure menu.

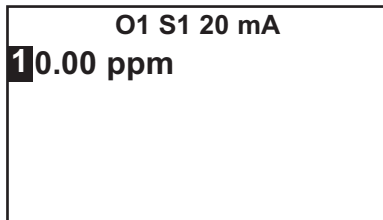

6. For practice, change the 20 mA setting for output 1 to 8.5 ppm.

- Move the cursor to the **O1 S1 20 mA: 10.00** line and press ENTER.
- The screen at left appears.
- Use the navigation keys to change 10.00 to 8.5 ppm. Use the left and right keys to move from digit to digit. Use the up and down keys to increase or decrease the numeral.
- To move the decimal point, press the left or right navigation key until the decimal point is highlighted. Press the up key to move the decimal point to the right. Press the down key to move to the left.
- Press ENTER to store the setting.

Output Range	
O1 S1 4mA:	0.000 ppm
<b>O1 S1 20mA:</b>	<b>08.50 ppm</b>
O2 S1 4mA:	0.0C
O2 S1 20mA:	100.0C

7. The display returns to the summary screen at left. Note that the 20 mA setting for output1 has changed to 8.5 ppm.
8. To return to the main menu, press MENU. To return to the main display, press MENU then EXIT.

## 4.4 SECURITY

### 4.4.1 How the Security Code Works

Security codes prevent accidental or unwanted changes to program settings or calibrations. There are three levels of security.

- a. A user can view the default display and diagnostic screens only.
- b. A user has access to the calibration and hold menus only.
- c. A user has access to all menus.

Security Code
<b>000</b>

1. If a security code has been programmed, pressing MENU causes the security screen to appear.
2. Enter the three-digit security code.
3. If the entry is correct, the main MENU screen appears. The user has access to the sub-menus the code entitles him to.
4. If the entry is wrong, the invalid code screen appears.

### 4.4.2 Assigning Security Codes.

See Section 5.7.

### 4.4.3 Bypassing Security Codes

Call the factory.

## 4.5 USING HOLD

### 4.5.1 Purpose

To prevent unwanted alarms and improper operation of control systems or dosing pumps, place the alarms and outputs assigned to the sensor in hold before removing it for maintenance. Hold is also useful if calibration, for example, buffering a pH sensor, will cause an out of limits condition. During hold, outputs assigned to the sensor remain at the last value, and alarms assigned to the sensor remain in their present state.

Once in hold, the sensor remains in hold until hold is turned off. However, if power is lost then restored, hold will automatically be turned off.

### 4.5.2 Using the Hold Function.

1. Press MENU. The main menu screen appears. Move the cursor to **Program**.

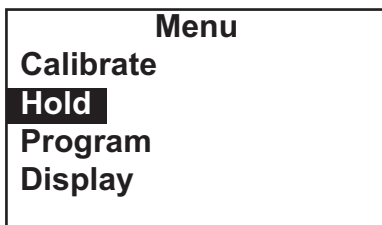

2. Choose HOLD.

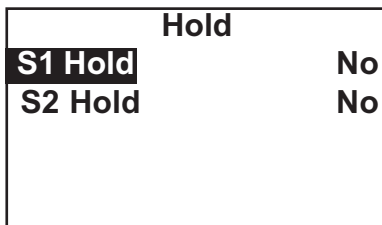

3. The screen shows the current hold status for each sensor. Select the sensor to be put in hold. Press ENTER.

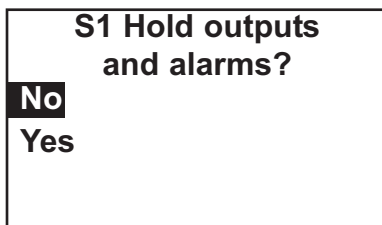

4. To put the sensor in hold, choose **Yes**. To take the sensor out of hold, choose **No**.

**Once in hold, the sensor remains in hold until hold is turned off.** However, if power is lost then restored, hold will automatically be turned off.

### 4.6 CONFIGURING THE MAIN DISPLAY

The main display can be configured to meet user requirements.

1. Press MENU. The main menu screen appears. Move the cursor to **Display** and press ENTER.
2. The screen shows the present configuration. There are four items: **Main Format, Language, Warning, and Contrast.**

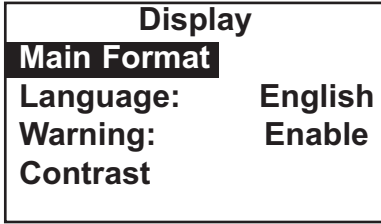

To make a change, move the cursor to the desired line and press ENTER. A screen appears in which the present setting can be edited. Press ENTER to store the setting.

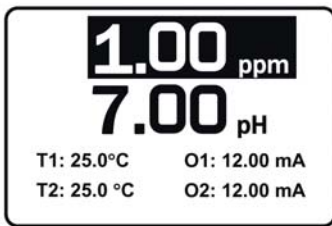

3. **Main Format** lets you configure the second line in the main display as well as the four smaller items at the bottom of the display. Move the cursor to the desired place in the screen and press ENTER. Scroll through the list of items and select the parameter you wish displayed. Once you are done making changes, press EXIT twice to return to the display menu. Press MENU then EXIT to return to the main display.

The following abbreviations are used in the quadrant display.

O	output
T	temperature (live)
Tm	temperature (manual)
M	measurement
mV	mV (pH)

I	sensor current (Cl)
Slp	slope
GI	glass impedance (pH)
RZ	ref. impedance (pH)

4. Choose **Language** to change the language used in the display.
5. Choose **Warning** to disable or enable warning messages.
6. Choose **Contrast** to change the display contrast. To change the contrast, choose either lighter or darker and press ENTER. Every time you press ENTER the display will become lighter or darker.

## SECTION 5.0

# PROGRAMMING THE ANALYZER

### 5.1 GENERAL

This section describes how to make the following program settings using the local keypad.

- a. Configure and assign values to the analog current outputs.
- b. Configure and assign values to the alarm relays (if the alarm board is installed).
- c. Choose the type of chlorine measurement being made. This step is necessary because the analyzer used with the FCLi can measure forms of chlorine other than free chlorine.
- d. Choose temperature units and automatic or manual temperature correction for chlorine and pH (if a pH sensor is installed).
- e. Set two levels of security codes.
- f. Assign limits to diagnostic warnings (applies only if a pH sensor is installed).
- g. Reset the analyzer to factory default settings.

### 5.2 DEFAULT SETTINGS

The analyzer leaves the factory with the default settings shown in Table 5.1. The setting can be changed by the user to any value shown in the column labeled CHOICES.

TABLE 5-1. DEFAULT SETTINGS

ITEM	CHOICES	DEFAULT
<b>Sensor assignment</b>		
1. Sensor 1	chlorine	chlorine
2. Sensor 2	pH	pH
<b>Outputs</b>		
1. Assignments (if FCLi-01)		
a. output 1	chlorine, temp	chlorine
b. output 2	chlorine, temp	temp
2. Assignments (if FCLi-02)		
a. output 1	chlorine, pH, temp	chlorine
b. output 2	chlorine, pH, temp	pH
3. Range	0-20 or 4-20 mA	4 – 20 mA
4. 0 or 4 mA setting		
a. chlorine and pH	-9999 to +9999	0
b. temperature	-999.9 to +999.9	0
5. 20 mA setting		
a. chlorine	-9999 to +9999	10
b. pH	-9999 to +9999	14
c. temperature	-999.9 to +999.9	0
6. Fault current (fixed)	0.00 to 22.00 mA	22.00 mA
7. Dampening	0 to 999 sec	0 sec
8. Simulate	0.00 to 22.00 mA	12.00 mA
<b>Alarms</b>		
1. Logic	high or low	AL1 low, AL2,3,4 high
2. Assignments		
a. AL1 and AL2	chlorine, pH, temp, fault, interval timer	chlorine (sensor 1)
b. AL3 and AL4	chlorine, pH, temp, fault, interval timer	temperature (sensor 1)
3. Deadband	0 to 9999	0
4. Interval timer settings		
a. interval time	0.0 to 999.9 hr	24.0 hr
b. on time	0 to 999 sec	10 sec
c. recovery time	0 to 999 sec	60 sec

**TABLE 5-1. DEFAULT SETTINGS (continued)**

ITEM	CHOICES	DEFAULT
<b>Measurement</b>		
1. Chlorine (sensor 1)		
a. units	ppm or mg/L	ppm
b. resolution	0.01 or 0.001	0.001
c. input filter	0 to 999 sec	5 sec
2. pH (sensor 2)		
a. pre-amplifier location	analyzer or sensor/junction box	analyzer
b. solution temperature correction	on or off	off
c. resolution	0.01 or 0.1	0.01
d. input filter	0 to 999 sec	2 sec
e. reference impedance	low or high	low
<b>Temperature related settings</b>		
1. Units	°C or °F	°C
2. Temperature compensation	automatic or manual	automatic
<b>Security Code</b>		
1. Calibrate/Hold	000 to 999	000
2. Program/Display	000 to 999	000
<b>pH Sensor Diagnostic Limits</b>		
1. Reference offset	0 to 9999 mV	60 mV
2. Diagnostics	on or off	on
3. Glass impedance temperature correction	on or off	on
4. Glass fault (low impedance)	0 to 9999 MΩ	10 MΩ
5. Glass fault (high impedance)	0 to 9999 MΩ	1500 MΩ
6. Reference fault (high impedance)	0 to 9999 kΩ	40 kΩ
<b>Calibration-pH</b>		
1. Stabilization criteria		
a. time interval	0 to 99 sec	10 sec
b. pH change	0.01 to 1.00 pH	0.02 pH
2. User-entered slope	0.00 to 99.99 mV/pH	59.16 mV/pH
3. User-entered offset	-999 to +999 mV	0 mV
<b>Calibration-Analog Outputs</b>		
1. 4 mA	0.000 to 22.000 mA	4.000 mA
2. 20 mA	0.000 to 22.000 mA	20.000 mA

## 5.3 CONFIGURING, RANGING, AND SIMULATING OUTPUTS.

### 5.3.1 Purpose

This section describes how to configure, range, and simulate the two analog current outputs. **CONFIGURE THE OUTPUTS FIRST.**

1. Configuring an output means...
  - a. Assigning a sensor and measurement (chlorine, pH, or temperature) to an output.
  - b. Selecting a 4-20 mA or 0-20 mA output.
  - c. Choosing a linear or logarithmic output.
  - d. Turning output dampening on or off.
  - e. Selecting the value the output current goes to if the analyzer detects a fault.
2. Ranging the outputs means assigning values to the low (0 or 4 mA) and high (20 mA) outputs.
3. Simulating an output means making the analyzer generate an output current equal to the value entered by the user.

### 5.3.2 Definitions

1. **ANALOG CURRENT OUTPUT.** The analyzer provides either a continuous 4-20 mA or 0-20 mA output signal proportional to chlorine, temperature, or pH.
2. **ASSIGNING AN OUTPUT.** The outputs are freely assignable. Outputs can be assigned to any sensor and to either the measurement or temperature.
3. **LINEAR OUTPUT.** Linear output means the current is directly proportional to the value of the variable assigned to the output (chlorine, pH, or temperature).
4. **LOGARITHMIC OUTPUT.** Logarithmic output means the current is directly proportional to the common logarithm of the variable assigned to the output (chlorine, pH, or temperature).
5. **DAMPENING.** Output dampening smoothes out noisy readings. It also increases response time. The time selected for output dampening is the time to reach 63% of the final reading following a step change. Output dampening does not affect the response time of the display.
6. **FAULT.** The analyzer continuously monitors itself and the sensor(s) for faults. If the analyzer detects a fault, a fault message appears in the main display. At the same time the output current goes to the value programmed in this section. There are two output fault modes: fixed and live. Fixed means the selected output goes the previously programmed value (between 0.00 and 22.00 mA) when a fault occurs. Live means the selected output is unaffected when a fault occurs.
7. **RANGING AN OUTPUT.** The outputs are fully rangeable, including negative numbers. If the output is logarithmic, assigned values must be positive.

5.3.3. Procedure – Configure Outputs.

1. Press MENU. The main menu screen appears. Move the cursor to Program and press ENTER.

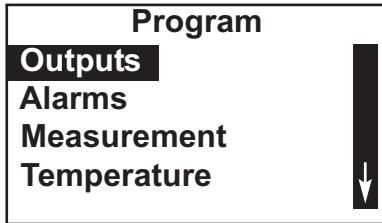

2. The cursor will be on **Outputs**. Press ENTER.

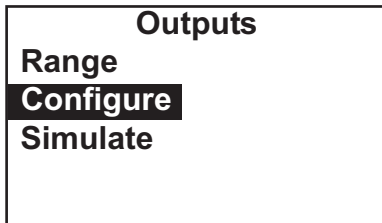

3. Choose **Configure**.

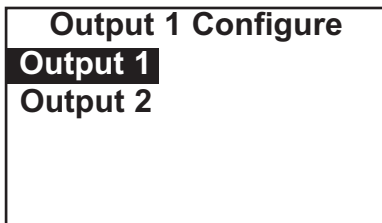

4. Choose **Output 1** or **Output 2**.

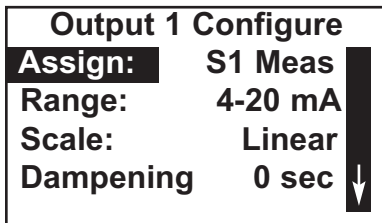

5. The screen shows the present configuration. There are six items: **Assign** (**S1** is sensor 1, **S2** is sensor 2), **Range**, **Scale**, **Dampening**, **Fault Mode**, and **Fault Value**. To display the fifth and sixth items, scroll to the bottom of the screen and continue scrolling.

To make a change, move the cursor to the desired line and press ENTER. A screen will appear in which the present setting can be edited. Press ENTER to store the setting.

For an explanation of terms, see sections 5.3.1 and 5.3.2.

6. To return to the main display, press MENU then EXIT.

5.3.4. Procedure – Ranging Outputs.

1. Press MENU. The main menu screen appears. Move the cursor to **Program** and press ENTER.

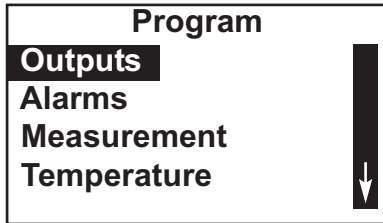

2. The cursor will be on **Outputs**. Press ENTER.

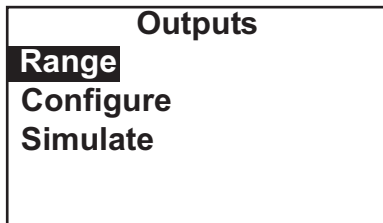

3. Choose **Range**.

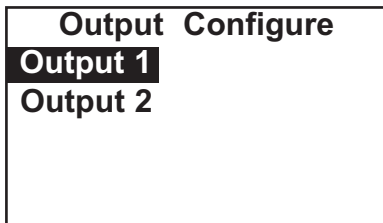

4. Choose **Output 1** or **Output 2**.

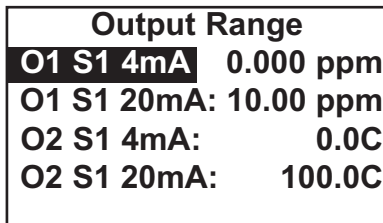

5. The screen shows the present settings for the outputs. **O1** is output 1, **O2** is output 2, **S1** is sensor 1, and **S2** is sensor 2.

To make a change, move the cursor to the desired line and press ENTER. A screen will appear in which the present setting can be edited. Press ENTER to store the setting.

For an explanation of terms, see sections 5.3.1 and 5.3.2.

6. To return to the main display, press MENU then EXIT.

### 5.3.5 Procedure – Simulating Outputs

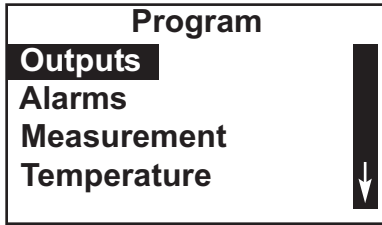

1. Press MENU. The main menu screen appears. Move the cursor to Program and press ENTER.
2. The cursor will be on **Outputs**. Press ENTER.

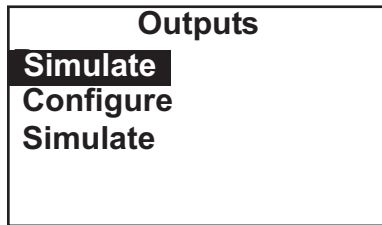

3. Choose **Simulate**.

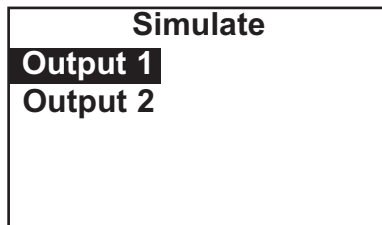

4. Choose **Output 1** or **Output 2**.

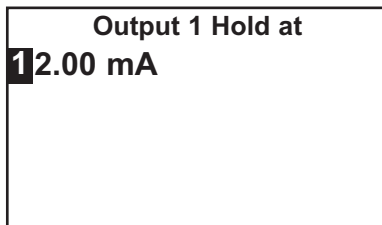

5. Enter the desired simulated output current. To end the simulated current, press MENU or EXIT.

## 5.4 CONFIGURING ALARMS AND ASSIGNING SETPOINTS.

### 5.4.1 Purpose

The Model FCLi analyzer has an **optional** alarm relay board. This section describes how to configure and assign setpoints to the alarm relays, simulate alarm action, and synchronize interval timers. **CONFIGURE THE ALARMS FIRST.**

1. Configuring an alarm means...
  - a. Assigning a sensor and measurement (chlorine, pH, or temperature) to an alarm. An alarm relay can also be used as a timer.
  - b. Selecting high or low logic.
  - c. Choosing a deadband.
  - d. Setting the interval timer parameters.
2. Simulating an alarm means making the analyzer energize or de-energize an alarm relay.

**5.4.2 Definitions**

1. **ASSIGNING ALARMS.** There are four alarms relays. The relays are freely assignable to any sensor and to either the measurement (for example, chlorine) or temperature. Alarm relays can also be assigned to operate as interval timers or as fault alarms. A fault alarm activates when the analyzer detects a fault in either itself or the sensor.
2. **FAULT ALARM.** A fault condition exists when the analyzer detects a problem with a sensor or with the analyzer itself that is likely to cause seriously erroneous readings. If an alarm was programmed as a fault alarm, the alarm will activate. At the same time a fault message will appear in the main display.
3. **ALARM LOGIC, SETPOINTS, AND DEADBANDS.** See Figures 5-1 and 5-2.
4. **INTERVAL TIMER.** Any alarm relay can be used as an interval timer. Figure 5-3 shows how the timer operates. While the interval timer is operating, the main display, analog output, and assigned alarms for the sensor(s) can be put on hold. During hold, the main display remains at the last value.
5. **SYNCHRONIZE TIMER.** If two or more relays are being used as interval timers, choosing synchronize timers will cause each timer to start one minute later than the preceding timer.

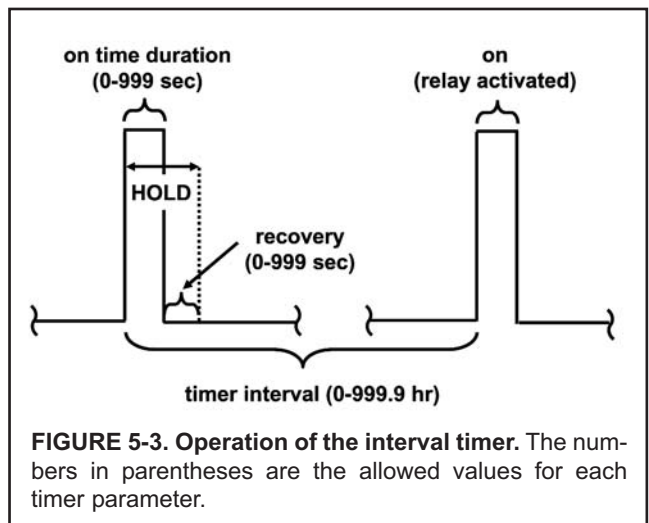
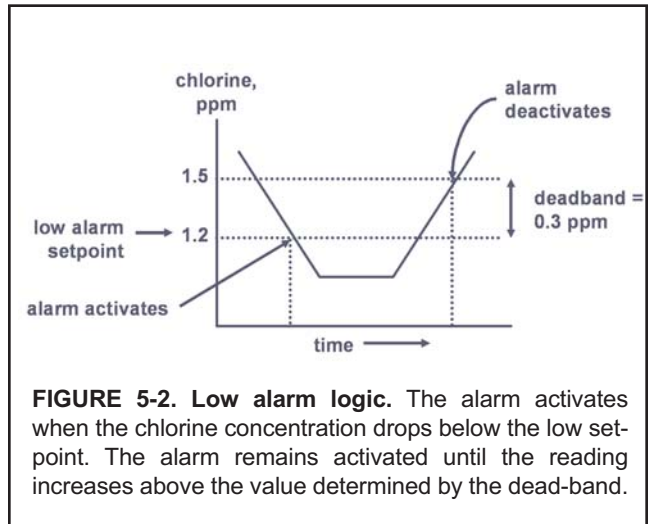
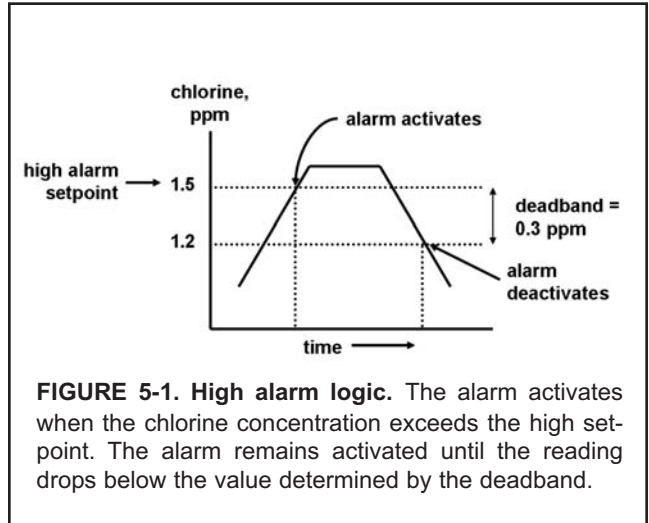

5.4.3 Procedure – Configuring Alarms and Assigning Setpoints

1. Press MENU. The main menu screen appears. Move the cursor to **Program** and press ENTER.

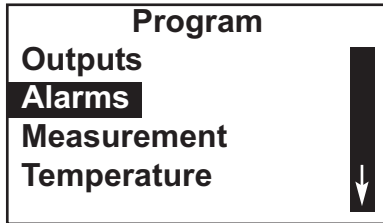

2. Choose **Alarms**.

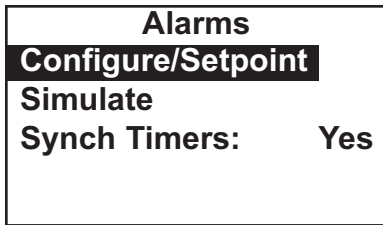

3. Choose **Configure/Setpoint**.

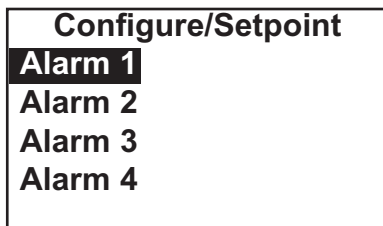

4. Choose **Alarm 1, Alarm 2, Alarm 3, or Alarm 4**.

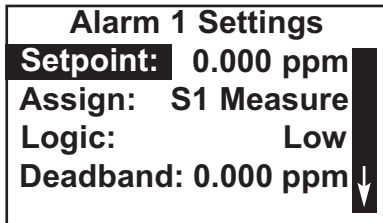

5. The screen summarizes the present configuration and setpoints. There are nine items: **Setpoint, Assign (S1 is sensor 1 and S2 is sensor 2), Logic, Deadband, Interval time, On time, Recover time, and Hold while active**. The last four items describe the operation of the timer. Only four items are shown at a time. To view the remaining items, scroll to the bottom of the screen and continue scrolling.

To make a change, move the cursor to the desired line and press ENTER. A screen will appear in which the present setting can be edited. Press ENTER to store the setting.

For an explanation of terms, see sections 5.4.1 and 5.4.2.

6. To return to the main display, press MENU then EXIT.

## 5.4.4 Procedure – Simulating Alarms

1. Press MENU. The main menu screen appears. Move the cursor to **Program** and press ENTER.

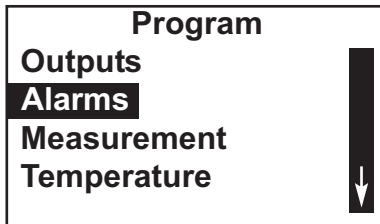

2. Choose **Alarms**.

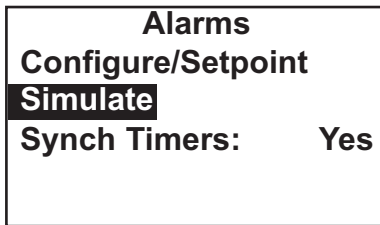

3. Choose **Simulate**.

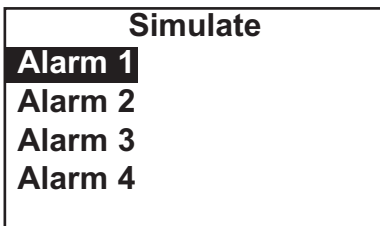

4. Choose **Alarm 1, Alarm 2, Alarm 3, or Alarm 4**.

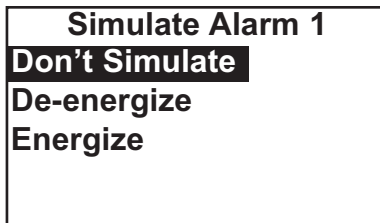

5. Choose **Don't simulate, De-energize, or Energize**. Press MENU or EXIT to end simulation.

5.4.4 Procedure – Synchronizing Timers

1. **Synch Timers** is available only if two or more alarm relays have been configured as interval timers.
2. Press MENU. The main menu screen appears. Move the cursor to Program and press ENTER.
3. Choose **Alarms**.

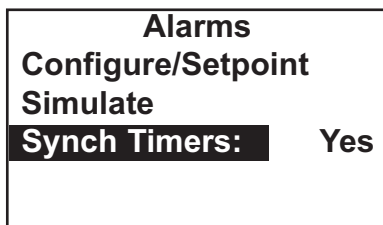
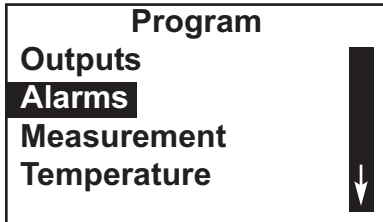

4. The summary display shows the current **Synch Timers** setting (**Yes** or **No**).  
To make a change, choose **Synch Timers** and press ENTER. A screen will appear in which the present setting can be edited. Press ENTER to store the setting.  
For an explanation of terms, see sections 5.4.1 and 5.4.2.

5. To return to the main display, press MENU then EXIT.

## 5.5 CONFIGURING THE MEASUREMENT.

### 5.5.1 Purpose

This section describes how to do the following:

1. Program the analyzer to measure free chlorine using the pH-independent free chlorine sensor Model 498CL-01. This step is necessary because the analyzer can be used with other sensors to measure other chlorine oxidants.
2. Program the analyzer to measure pH. This step is necessary only if a Model FCLi-02 is being programmed.
3. Set the level of electronic filtering of the sensor current.
4. Make various pH measurement settings.

### 5.5.2 Definitions - Chlorine

1. CHLORINE OXIDANTS. Although the FCLi is used to measure free chlorine only, the analyzer used in the FCLi can be used to measure other chlorine oxidants, for example monochloramine and total chlorine.
2. FILTER. The analyzer applies a software filter to the raw sensor current. The filter reduces noisy readings, but increases the response time. Only the filter time can be changed. The filter threshold cannot be changed.
3. RESOLUTION. If the chlorine concentration is less than 1.00 ppm (mg/L), the display resolution can be set to 0.XX or 0.XXX.

### 5.5.3 Definitions – pH/ORP

1. ORP. ORP is oxidation-reduction potential. It is the voltage difference between a noble metal indicator electrode (like platinum) and a silver/silver chloride reference electrode.
2. REDOX. Redox is redox potential. Redox potential is measured the same way as ORP. The sign of the redox potential is the negative of ORP.
3. PREAMPLIFIER. The pH signal has high impedance. Before it can be used, it must be converted into a low impedance signal. The pre-amplifier accomplishes this task, and it can be located in either the analyzer or sensor. In the FCLi the pre-amplifier is located in the analyzer.
4. SOLUTION TEMPERATURE CORRECTION. The pH of a solution, particularly an alkaline one, is a function of temperature. If the temperature changes, so will the pH, even though the concentration of the acid or base remained constant. Solution temperature compensation converts the pH at the measurement temperature to the pH at a reference temperature (25°C). Generally, solution temperature compensation is used only in the determination of pH in condensate, feedwater, and boiler water in steam electric power plants.
5. RESOLUTION. The pH display resolution is user selectable: XX.X or XX.XX.
6. FILTER. The analyzer applies a software filter to the raw voltage value coming from the pH sensor. The filter reduces noisy readings, but increases the response time. Only the filter time can be changed. The filter threshold cannot be changed.
7. REFERENCE IMPEDANCE. Usually the impedance of the reference electrode in a pH sensor is low. However, a few pH sensors have high reference impedance, and the analyzer must be told that the reference impedance is high. The pH sensor used in the FCLi-02 has low reference impedance.

5.5.4 Procedure – Configuring the Measurement

1. Press MENU. The main menu screen appears. Move the cursor to Program and press ENTER.

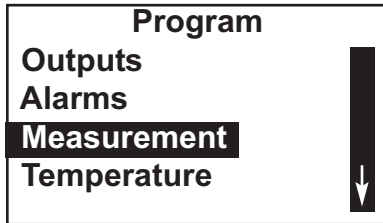

2. Choose **Measurement**.

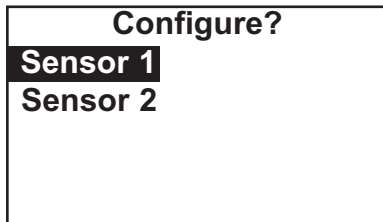

3. The screen at left appears only if you have an FCLi-02. Choose **Sensor 1** (chlorine) or **Sensor 2** (pH).

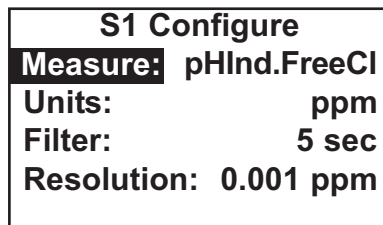

4. The screen summarizes the present configuration for sensor 1 (chlorine). There are four items: **Measure**, **Units**, **Filter**, and **Resolution**

To make a change, move the cursor to the desired line and press ENTER. A screen will appear in which the present setting can be edited. To store the setting press ENTER.

- a. For **Measurement** choose **pH Independ. Free Cl**. Do not choose **Free Chlorine**.
- b. Leave **Filter** at the default value unless readings are noisy.

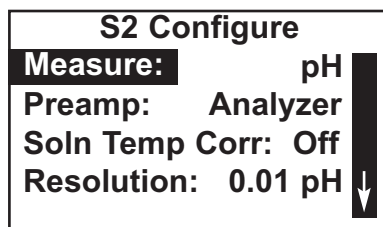

5. The screen summarizes the present configuration for sensor 2 (pH). There are six items: **Measure**, **Preamp**, **Sol'n Temp Corr**, **Resolution**, **Filter**, and **Reference Z** (reference impedance). Only four items are shown at a time. To view the remaining items, scroll to the bottom of the screen and continue scrolling.

To make a change, move the cursor to the desired line and press ENTER. A screen will appear in which the present setting can be edited. To store the setting press ENTER.

- a. For **pH Preamp**, choose **Analyzer**
- b. For **pH Reference Z**, choose **Low**.
- c. Leave **Filter** at the default value unless readings are noisy.

For an explanation of terms, see sections 5.5.2 and 5.5.3.

6. To return to the main display, press MENU then EXIT.

## 5.6 CONFIGURING TEMPERATURE RELATED SETTINGS

### 5.6.1 Purpose

This section describes how to do the following:

1. Choose temperature units.
2. Choose automatic or manual temperature correction for membrane permeability (chlorine sensor).
3. Choose automatic or manual temperature compensation for pH.
4. Enter a temperature for manual temperature compensation.

### 5.6.2 Definitions - Chlorine

1. **AUTOMATIC TEMPERATURE CORRECTION.** The free chlorine sensor is a membrane-covered amperometric sensor. It produces a current directly proportional to the rate of diffusion of free chlorine through the membrane. The diffusion rate, in turn, depends on the concentration of chlorine in the sample and the membrane permeability. Membrane permeability is a function of temperature. As temperature increases, permeability increases. Thus, an increase in temperature will cause the sensor current and the analyzer reading to increase even though the concentration of chlorine remained constant. In automatic temperature correction, the analyzer uses the temperature measured by the sensor to continuously correct for changes in membrane permeability.
2. **MANUAL TEMPERATURE CORRECTION.** In manual temperature correction, the analyzer uses the temperature entered by the user for correction. It does not use the actual process temperature. Do NOT use manual temperature correction unless the measurement and calibration temperatures differ by no more than about 2°C. Manual temperature correction is useful if the sensor temperature element has failed and a replacement sensor is not available.

### 5.6.3 Definitions – pH

1. **AUTOMATIC TEMPERATURE COMPENSATION.** A pH sensor produces a voltage that depends on the pH of the sample. The analyzer uses a temperature-dependent factor to convert the voltage to pH. In automatic temperature compensation, the analyzer uses the temperature measured by the pH sensor to calculate the conversion factor. For maximum accuracy, use automatic temperature compensation.
2. **MANUAL TEMPERATURE COMPENSATION.** In manual temperature compensation the analyzer converts measured voltage to pH using the temperature entered by the user. It does not use the actual process temperature. Do NOT use manual temperature compensation unless the process temperature varies no more than about  $\pm 2^\circ\text{C}$  or the pH is between 6 and 8. Manual temperature compensation is useful if the sensor temperature element has failed and a replacement is not available.

### 5.6.4 Procedure – Configuring Temperature Related Settings

1. Press MENU. The main menu screen appears. Move the cursor to Program and press ENTER.
2. Choose **Temperature**.

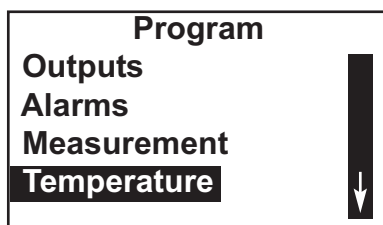

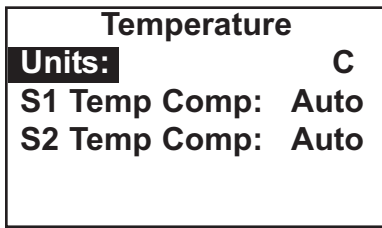

3. The screen summarizes the present sensor configuration. There will be between three and five items. **Units**, **S1 Temp Comp**, and **S2 Temp Comp** always appear. If manual temperature compensation was selected, the manual temperature values entered for each sensor (**S1 and S2 Manual**) will also appear. Only four items are shown at a time. To view the remaining items, scroll to the bottom of the screen and continue scrolling.

To make a change, move the cursor to the desired line and press ENTER. A screen will appear in which the present setting can be edited. To store a setting, press ENTER.

4. For an explanation of terms, see sections 5.6.2 and 5.6.3.
5. To return to the main display, press MENU then EXIT.

## 5.7 CONFIGURING SECURITY SETTINGS

### 5.7.1 Purpose

This section describes how to set security codes. There are three levels of security.

- a. A user can view the default display and diagnostic screens only.
- b. A user has access to the calibration and hold menus only.
- c. A user has access to all menus.

The security code is a three digit number. The table shows what happens when different security codes (XXX and YYY) are assigned to **Calibration/Hold** and **All**. 000 means no security.

Calibration/Hold	All	What happens...
000	XXX	User enters XXX and has access to all menus.
XXX	YYY	User enters XXX and has access to Calibration and Hold menus only. User enters YYY and has access to all menus.
XXX	000	User needs no security code to have access to all menus.
000	000	User needs no security code to have access to all menus.

### 5.7.2 Procedure – Configuring Security Settings

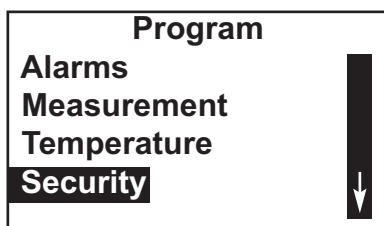

1. Press MENU. The main menu screen appears. Move the cursor to Program and press ENTER.
2. Scroll to the bottom of the screen and continue scrolling until **Security** is highlighted. Press ENTER.

Security	
Calibration/Hold	000
All	000

- The screen shows the existing security codes. To make a change, move the cursor to the desired line and press ENTER. A screen will appear in which the present setting can be edited. Press ENTER to store the change. The security code takes effect two minutes after pressing ENTER.
- To return to the main display, press MENU then EXIT.

## 5.8 SETTING UP DIAGNOSTICS

### 5.8.1 Purpose

#### NOTE

Diagnostic setup applies only to pH sensors. It appears only if you are using the FCLi-02.

This section describes how to do the following:

- Turn pH sensor diagnostics on and off.
- Set pH sensor diagnostic limits.

### 5.8.2 Definitions

- DIAGNOSTICS.** pH sensor diagnostics are useful in troubleshooting calibration problems and in predicting when a pH sensor should be replaced. Diagnostics can also alert the user that the sensor is no longer submerged in the process liquid.
- REFERENCE OFFSET.** pH sensors are designed to have a potential of 0 mV in pH 7 buffer. The reference offset is the actual potential (in mV) in pH 7 buffer. A new sensor typically has a reference offset of a few mV. Old sensors can have offsets of 60 mV or more.
- GLASS AND REFERENCE IMPEDANCE.** During operation, the analyzer continuously measures the impedance of the pH glass membrane. If the pH sensor has a solution ground, the analyzer will also continuously measure the impedance of the reference junction. The Model 3900VP pH sensor supplied with the FCLi-02 has a solution ground. The Model 399VP sensor, supplied with earlier versions of the FCL-02, did not have a solution ground. If you are using a 399VP sensor, reference impedance diagnostics will not be available. Glass and reference impedance measurements provide useful information about sensor health and cleanliness.
- GLASS IMPEDANCE TEMPERATURE CORRECTION.** The impedance of a glass electrode is a strong function of temperature. As temperature decreases, the impedance increases. For glass impedance to be a useful indicator of sensor condition, the impedance must be corrected to a reference temperature.
- GLASS FAULT HIGH.** A typical glass electrode has an impedance of about 100 M $\Omega$ . As the sensor ages, glass impedance increases. Extremely high impedance (greater than about 1000M $\Omega$ ) implies the sensor is nearing the end of its life. High impedance may also mean that the sensor is not submerged in the process liquid.

5.8.2 Procedure – Setting Up Diagnostics

1. Press MENU. The main menu screen appears. Move the cursor to **Program** and press ENTER.



2. Scroll to the bottom of the screen and continuing scrolling until **Diagnostic Setup** is highlighted. Press ENTER.

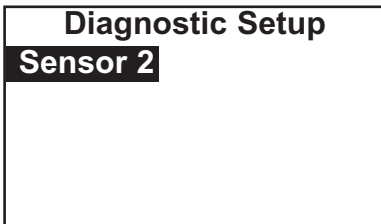

3. Diagnostics are available only for pH sensors. In the FCLi-02 the pH sensor is sensor 2. Press ENTER.

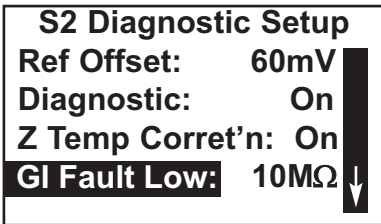

4. The screen summarizes the present diagnostic settings and limits. There are nine items. To show items beyond the first four in the list, scroll to the bottom of the list and continue scrolling.

To make a change, move the cursor to the desired line and press ENTER. A screen will appear in which the present setting can be edited. It is recommended that the settings be kept at the default values:

Setting	Default
Ref Offset	60 mV
Diagnostic	On
Z Temp Correct'n	On
GI Fault Hi	1000 MΩ
Ref Fault Hi	20 kΩ

5. To return to the main display, press MENU then EXIT.

## 5.9 RESETTING THE ANALYZER

### 5.9.1 Purpose

This section describes how to clear user-entered values and restore default settings. There are three resets:

1. Resetting to factory default values clears **ALL** user entered settings, including sensor and analog output calibration, and returns **ALL** settings and calibration values to the factory defaults.
2. Resetting a sensor calibration to the default values clears user-entered calibration data for the selected sensor but leaves all other user-entered data unaffected.
3. Resetting the analog output calibration clears only the user-entered analog output calibration. It leaves all other user-entered settings unchanged.

### 5.9.2 Procedure – Resetting the Analyzer

1. Press MENU. The main menu screen appears. Move the cursor to Program and press ENTER.

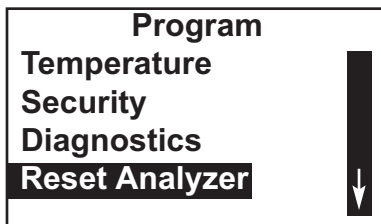

2. Scroll to the bottom of the screen and continue scrolling until **Reset Analyzer** is highlighted. Press ENTER.



3. Choose whether to reset all user-entered values (**Factory Defaults**), sensor calibration (**Sensor Cal Only**), or output calibration (**Output Cal Only**). If you choose **Sensor Cal Only** or **Output Cal Only** a second screen appears in which you can select which sensor or output calibration to reset.

4. To return to the main display, press MENU then EXIT.

# SECTION 6.0 CALIBRATION

## 6.1 INTRODUCTION

The calibrate menu allows the user to do the following:

1. Calibrate the temperature sensing element in the chlorine and pH sensors.
2. Calibrate the chlorine sensor.
3. Calibrate the pH sensor. Four methods are available.
  - a. Two-point calibration with automatic buffer recognition.
  - b. Manual two-point calibration.
  - c. Standardization.
  - d. Manual entry of pH sensor slope and offset.
4. Calibrate the analog outputs.

## 6.2 CALIBRATING TEMPERATURE

### 6.2.1 Purpose

Temperature is important in the measurement of chlorine and pH for different reasons.

The free chlorine sensor is a membrane-covered amperometric sensor. As the sensor operates, free chlorine diffuses through the membrane and is consumed at an electrode immediately behind the membrane. The reaction produces a current that depends on the rate at which the free chlorine diffuses through the membrane. The diffusion rate, in turn, depends on the concentration of free chlorine and how easily it passes through the membrane (the membrane permeability). Because membrane permeability is a function of temperature, the sensor current will change if the temperature changes. To account for changes in sensor current caused by temperature alone, the analyzer automatically applies a membrane permeability correction. The membrane permeability changes about 3%/°C at 25°C, so a 1°C error in temperature produces about a 3% error in the reading.

Temperature is also important in pH measurements.

1. The analyzer uses a temperature dependent factor to convert measured cell voltage to pH. Normally, a slight inaccuracy in the temperature reading is unimportant unless the pH reading is significantly different from 7.00. Even then, the error is small. For example, at pH 12 and 25°C, a 1°C error produces a pH error less than  $\pm 0.02$ .
2. During auto calibration, the analyzer recognizes the buffer being used and calculates the actual pH of the buffer at the measured temperature. Because the pH of most buffers changes only slightly with temperature, reasonable errors in temperature do not produce large errors in the buffer pH. For example, a 1°C error causes **at most** an error of  $\pm 0.03$  in the calculated buffer pH.

Without calibration the accuracy of the temperature measurement is about  $\pm 0.4^\circ\text{C}$ . Calibrate the sensor/analyzer unit if

1.  $\pm 0.4^\circ\text{C}$  accuracy is not acceptable
2. the temperature measurement is suspected of being in error. Calibrate temperature by making the analyzer reading match the temperature measured with a **standard thermometer**.

6.2.2 Procedure

1. Remove the sensor from the flow cell. Place it in an insulated container of water along with a **calibrated thermometer**. Submerge at least the bottom two inches of the sensor.
2. Allow the sensor to reach thermal equilibrium. The time constant for both the chlorine and pH sensor is about 5 min., so it may take as long as 30 min for equilibration.

3. Press MENU. The main menu screen appears. The cursor will be on Calibrate. Press ENTER.

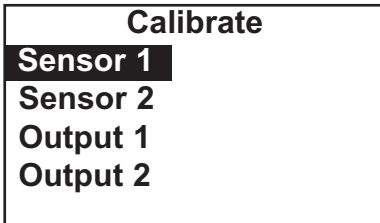

4. Choose the sensor you wish to calibrate. **Sensor 1** is the chlorine sensor. **Sensor 2** (if present) is the pH sensor.



5. Choose **Temperature**.

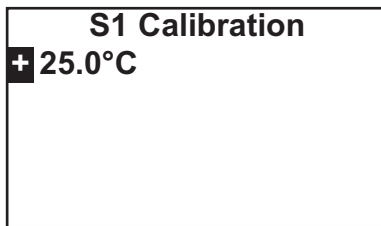

6. Change the display to match the temperature read from the calibrated thermometer. Press ENTER.

If the present temperature is more than 5°C different from the value entered, an error message appears. To force the analyzer to accept the calibration, choose Yes. To repeat the calibration, choose No. For troubleshooting assistance, see Section 9.10.

7. To return to the main display, press MENU then EXIT.

## 6.3 CALIBRATION — FREE CHLORINE

### 6.3.1 Purpose

As Figure 6-1 shows, a free chlorine sensor generates a current directly proportional to the concentration of free chlorine in the sample. Calibrating the sensor requires exposing it to a solution containing no chlorine (zero standard) and to a solution containing a known amount of chlorine (full-scale standard).

The zero standard is necessary because chlorine sensors, even when no chlorine is in the sample, generate a small current called the residual current or zero current. The analyzer compensates for the residual current by subtracting it from the measured current before converting the result to a chlorine value. New sensors require zeroing before being placed in service, and sensors should be zeroed whenever the electrolyte slurry is replaced. Either of the following makes a good zero standard:

- Deionized water.
- Tap water known to contain no chlorine. Expose tap water to bright sunlight for at least 24 hours.

The purpose of the full-scale standard is to establish the slope of the calibration curve. Because stable chlorine standards do not exist, **the sensor must be calibrated against a test run on a grab sample of the process liquid.** Several manufacturers offer portable test kits for this purpose. Observe the following precautions when taking and testing the grab sample.

- Take the grab sample from a point as close to the FCLi as possible. Be sure that taking the sample does not alter the flow of the sample to the unit. It is best to install the sample tap just downstream from the tap for the FCLi.
- Chlorine solutions are unstable. Run the test immediately after taking the sample. Try to calibrate the sensor when the chlorine concentration is at the upper end of the normal operating range.

### 6.3.2 Procedure-Zeroing the Sensor

1. **BEFORE ZEROING THE SENSOR, PLACE IT IN THE FLOW CELL AND ALLOW THE SENSOR TO OPERATE IN A FLOWING CHLORINATED SAMPLE FOR AT LEAST TWO HOURS.**
2. Remove the sensor from the flow cell and place it in the zero standard. See Section 6.3.1 for suggested zero standards. Be sure no air bubbles are trapped against the membrane and the auxiliary electrode is completely submerged. The sensor current will drop rapidly at first and then gradually reach a stable zero value. To monitor the sensor current, press the DIAG key. Choose **Sensor 1** (chlorine). The input current is the first line in the display. Note the units: nA is nanoamps, uA is microamps. Typical zero current for a new sensor is between 30 and 80 nA.

**IF THE SENSOR HAS A COPPER AUXILIARY ELECTRODE (THE METAL BAND AT THE BOTTOM OF THE SENSOR), NOTE THE FOLLOWING WHILE ZEROING THE SENSOR...**

**ZERO THE SENSOR IN A CONTAINER THAT MINIMIZES CONTACT BETWEEN THE AIR AND THE LIQUID SURFACE. DO NOT ALLOW THE SENSOR TO STAND IN THE ZERO SOLUTION FOR LONGER THAN TWO HOURS.** The combination of dissolved oxygen and the acidic fill solution from the sensor cause the external copper electrode to corrode. Corrosion produces copper ions, which diffuse into the sensor. Once inside the sensor, the copper ions undergo an electrochemical reaction that increases the background current. The copper also plates out on the cathode, and if the cathode becomes heavily coated, the sensor will be unusable until it is cleaned.

**LIMITING EXPOSURE TO AIR WHILE THE SENSOR IS BEING ZEROED, GREATLY REDUCES THE CORROSION RATE AND THE POTENTIAL FOR DAMAGE.**

**IF THE SENSOR HAS A STAINLESS STEEL AUXILIARY ELECTRODE (THE METAL BAND AT THE BOTTOM OF THE SENSOR), there are no special precautions to follow while zeroing the sensor.**

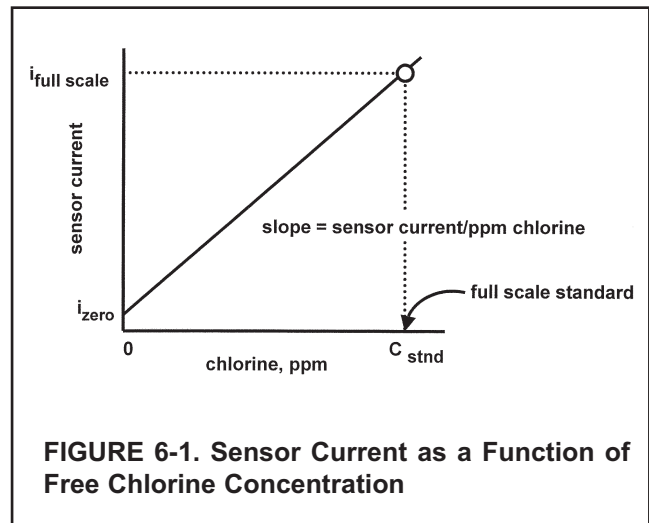

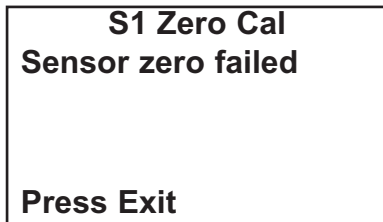
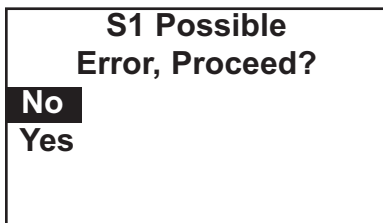
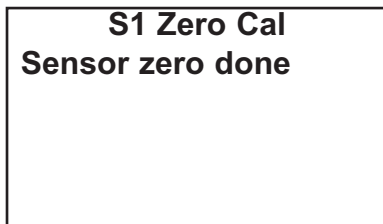
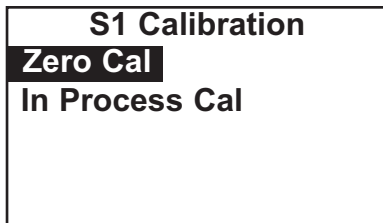
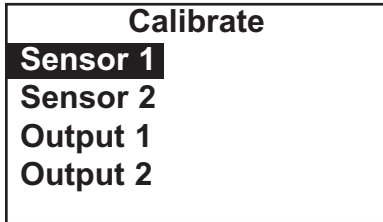

3. Press MENU. The main menu screen appears. The cursor will be on **Calibrate**. Press ENTER.
4. Choose the sensor you wish to calibrate. **Sensor 1** is the chlorine sensor. **Sensor 2** (if present) is the pH sensor.
5. Choose **pH Independ. Free Cl**.
6. Choose **Zero Cal**. The analyzer will automatically start the zero calibration
7. If the zero calibration was successful, the screen at left appears.

If the zero current is moderately larger than expected, an error message appears. To force the analyzer to accept the zero current, choose **Yes**. To repeat the calibration, choose **No**. For troubleshooting assistance, see Section 9.5.

If the zero current is much larger than expected, the zero calibration failure screen appears. The analyzer will not update the zero current. For troubleshooting assistance, see Section 9.5.

8. To return to the main display, press MENU then EXIT.

**6.3.2 Procedure-Calibrating the Sensor**

1. Place the chlorine sensor in the chlorine flow cell. Adjust the sample flow until water overflows the inside tube in the constant head flow controller.
2. Adjust the chlorine concentration until it is near the upper end of the operating range. Wait until the analyzer reading is stable before starting the calibration.

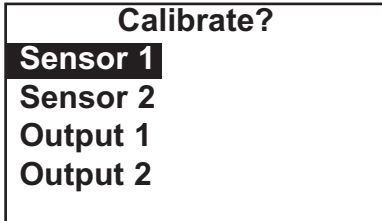

3. Press MENU. The main menu screen appears. The cursor will be on **Calibrate**. Press ENTER.
4. Choose the sensor you wish to calibrate. **Sensor 1** is the chlorine sensor. **Sensor 2** (if present) is the pH sensor.



5. Choose **pH Independ. Free Cl**.

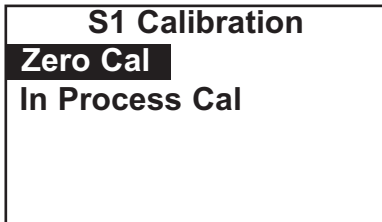

6. Choose **In Process Cal**

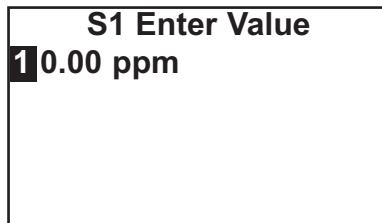

7. Follow the screen prompts: Once the reading is stable, press ENTER. Take the sample and press ENTER. At this point, the analyzer will store the present sensor current and temperature and use those values in the calibration.

Determine the free chlorine concentration in the sample and enter the value in the screen shown at left. See Section 6.3.1 for sampling and testing precautions.

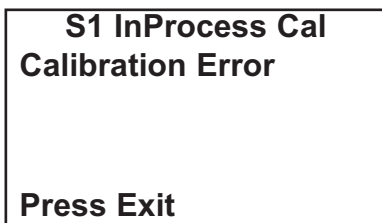

8. If the calibration is successful, the live reading will change to the value entered in step 7 and the display will return to the screen in step 6.

If the sensitivity is too far outside the range of expected values, the calibration error screen shown at left will appear. The analyzer will not update the calibration. For troubleshooting assistance, see Section 9.5.

9. To return to the main display, press MENU then EXIT.

## 6.4 CALIBRATION – pH

### 6.4.1 Purpose

A pH sensor consists of a glass and reference electrode. Usually, the two electrodes are combined into a single body, called a combination pH sensor. When the sensor is placed in an aqueous solution, it produces a voltage proportional to pH. An ideal pH sensor has a potential of 0 mV in pH 7 solution and a slope of -59.16 mV/pH at 25°C, that is, a unit increase in pH causes the potential to drop 59.16 mV. However, even in a new pH sensor the slope and offset are rarely equal to the ideal values. And, as the sensor ages, the offset typically increases and the slope decreases. For these reasons, a new pH sensor should be calibrated before use, and the sensor should be recalibrated at regular intervals. A pH sensor is calibrated by exposing it to standard solutions having known pH values. The standard solutions are called buffers.

### 6.4.2 Definitions

1. **AUTOMATIC BUFFER CALIBRATION.** In automatic buffer calibration, the analyzer recognizes the buffer and uses the temperature-corrected pH value in the calibration. The table lists the buffers the analyzer recognizes. Temperature-pH data are valid between at least 0 and 60°C.

Buffer list	Buffer pH
standard (note)	1.68, 3.56, 3.78, 4.01, 4.64, 6.86, 7.01, 7.41, 9.18, 10.01, 12.45
DIN19267	1.09, 3.06, 4.65, 6.79, 9.23, 12.75
Ingold	1.993, 4.005, 7.002, 9.206
Merck	2.002, 4.014, 7.003, 9.004, 12.009
Fisher	1.00, 2.00, 3.00, 4.00, 5.00, 6.00, 7.00, 8.00, 9.00, 10.00, 11.00

Note: With the exception of pH 7.01 buffer, the standard buffers are NIST buffers.

The analyzer also measures noise and drift and does not accept calibration data until readings are stable. Stability criteria are user-programmable.

The use of automatic buffer calibration minimizes errors and its use is strongly recommended.

2. **MANUAL BUFFER CALIBRATION.** In manual calibration, the user must enter the pH value of the buffer at the temperature of the buffer. In addition, the user must judge when pH readings are stable.
3. **SLOPE AND OFFSET.** Once the analyzer successfully completes the calibration, it calculates and displays the calibration slope and offset. The slope is reported as the slope at 25°C. Figure 6-2 defines the terms.
4. **STANDARDIZATION.** The pH measured by the analyzer can be changed to match the reading from a second or referee instrument. The process of making the two readings agree is called standardization. During standardization the difference between the two pH values is converted to the equivalent voltage. The voltage, called the reference offset, is added to all subsequent measured sensor voltages before they are converted to pH. If a pH sensor is buffered, then standardized and placed back in the buffer solution, the measured pH will differ from the buffer pH by an amount equivalent to the standardization offset.

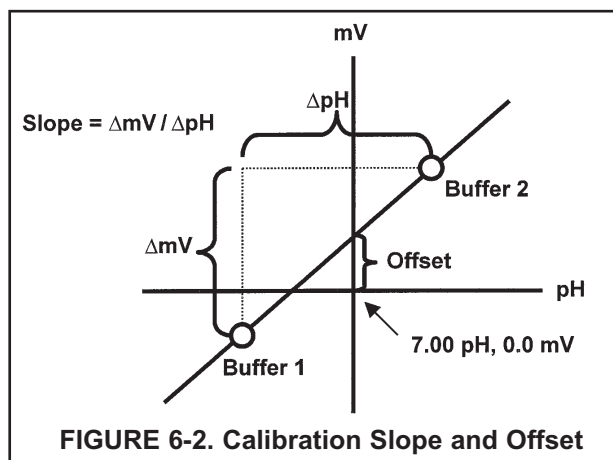

5. USER ENTERED SLOPE AND OFFSET. If the slope and offset are known from other measurements, they can be directly entered in the analyzer. Enter the slope as a positive number corrected to 25°C. To calculate the slope at 25°C from the slope at temperature t°C, use the equation:

$$\text{slope at 25°C} = (\text{slope at t°C}) \frac{298}{t°C + 273}$$

To calculate the offset use the following equation. The offset can be either positive or negative.

$$\text{offset} = mV_{\text{buffer}} - (\text{pH}_{\text{buffer}} - 7.00)(\text{slope at 25°C})$$

6. STABILITY SETTING. During automatic calibration, the analyzer measures noise and drift and does not accept calibration data until readings are stable. Calibration data will be accepted as soon as the pH reading is constant to within the factory-set limits of less than 0.02 pH change in 10 seconds. The stability settings are programmable.

**6.4.3 Procedure-Auto Calibration**

1. Obtain two buffer solutions. Ideally, the buffer pH values should bracket the range of pH to be measured.
2. Remove the sensor from the flow cell. If the process and buffer temperatures are appreciably different, place the sensor in a container of tap water at the buffer temperature. Do not start the calibration until the sensor has reached the buffer temperature.

3. Press MENU. The main menu screen appears. The cursor will be on **Calibrate**. Press ENTER.

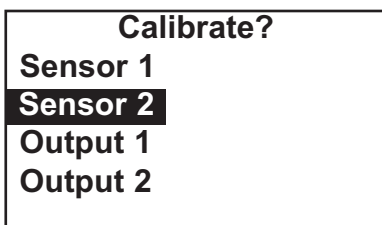

4. Choose the sensor you wish to calibrate. **Sensor 1** is the chlorine sensor. **Sensor 2** is the pH sensor.

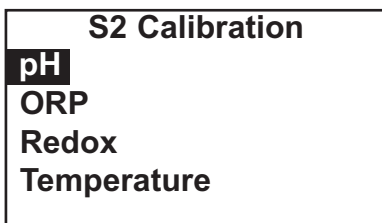

5. Choose **pH**.

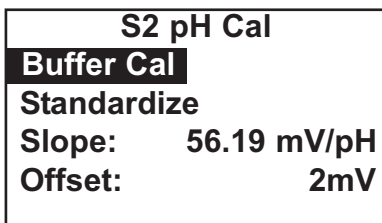

6. Choose **Buffer Cal**

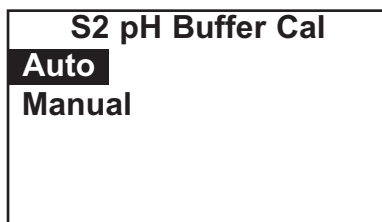

7. Choose **Auto**.

S2 pH Auto Cal  
Start Auto Cal  
Setup

S2 pH Auto Cal  
Place Sensor in  
Buffer 1  
Press Enter

S2 pH Auto Cal  
07.01 pH

S2 pH Auto Cal  
Place Sensor in  
Buffer 2  
Press Enter

S2 pH Auto Cal  
10.01 pH

S2 pH Auto Cal  
Slope: 59.16 mV/pH  
Offset: 10 mV

S2 Setup  
Stable Time: 10 sec  
Stable Delta: 0.02 pH  
Buffer: Standard

8. Choose **Start Auto Cal**.  
If you wish to change the stability criteria or the pH buffer list from the default values, choose **Setup** instead and go to step 14. The default stability is defined as a less than 0.02 pH change in 10 seconds. The default buffer list is **Standard**. See the table in section 6.4.2.
9. Rinse the sensor with water and place it in the first buffer. Be sure the glass bulb and reference junction are completely submerged. Swirl the sensor. Press ENTER.
10. Once the pH reading meets the stability requirements, the screen changes to show the nominal pH of the buffer. The nominal pH is the pH value at 25°C. The displayed value is not correct, press the up or down arrow key until the correct value is showing. Press ENTER.
11. Remove the sensor from the first buffer. Rinse with water and place it in the second buffer. Be sure the glass bulb and reference junction are completely submerged. Swirl the sensor. Press ENTER
12. Once the pH reading meets the stability requirements, the screen changes to show the nominal pH of the buffer. If the displayed value is not correct, press the up or down arrow keys until the correct value is showing. Press ENTER.
13. If the calibration is successful, the screen at left will be displayed for five seconds. The display will then return to the screen in step 6.  
If the calibration is not successful, the existing calibration data will not be changed. A screen will appear identifying the error (high slope, low slope, or offset error). For troubleshooting see section 9.6.
14. If you chose Setup in step 8, the screen at left appears. To make a change, move the cursor to the desired line and press ENTER. A screen will appear in which the present setting can be edited. Press ENTER to store the change.
15. To return to the main display, press MENU then EXIT.

**6.4.4 Procedure-Manual Calibration**

1. Obtain two buffer solutions. Ideally, the buffer pH values should bracket the range of pH values to be measured.
2. Remove the sensor from the flow cell. If the process and buffer temperatures are appreciably different, place the sensor in a container of tap water at the buffer temperature. Do not start the calibration until the sensor has reached the buffer temperature.

3. Press MENU. The main menu screen appears. The cursor will be on **Calibrate**. Press ENTER.

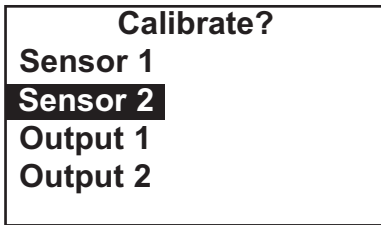

4. Choose the sensor you wish to calibrate. **Sensor 1** is the chlorine sensor. **Sensor 2** is the pH sensor.

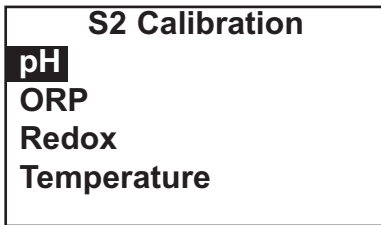

5. Choose **pH**.

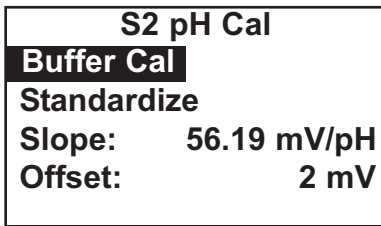

6. Choose **Buffer Cal**

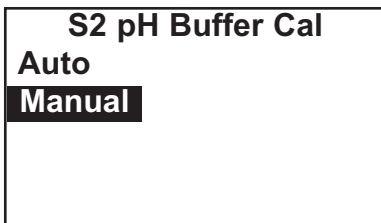

7. Choose **Manual**.

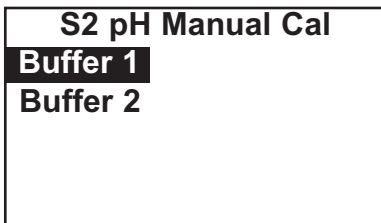

8. Choose **Buffer 1**.

9. Rinse the sensor with water and place it in the first buffer. Be sure the glass bulb and reference junction are completely submerged. Swirl the sensor.

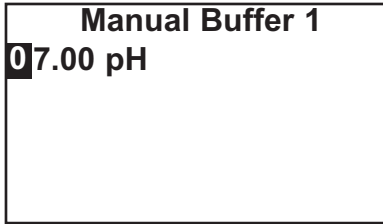

10. Watch the pH reading for sensor 2 (**S2**) at the top of the screen. Once the reading is stable, enter the pH value of the buffer at the buffer temperature and press ENTER.

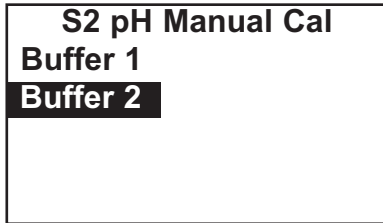

11. The display returns to the screen shown in step 8. Choose **Buffer 2**. Remove the sensor from the first buffer. Rinse with water and place it in the second buffer. Be sure the glass bulb and reference junction are completely submerged. Swirl the sensor. Press ENTER.

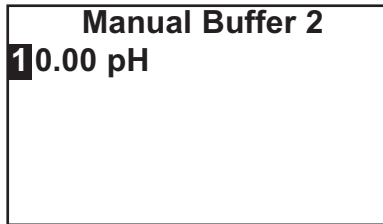

12. Watch the pH reading for sensor 2 (**S2**) at the top of the screen. Once the reading is stable, enter the pH value of the buffer at the buffer temperature and press ENTER.

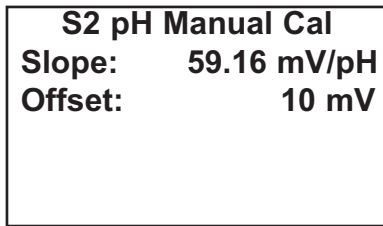

13. If the calibration is successful, the screen at left will be displayed for five seconds. The display will then return to screen in step 6.

If the calibration is not successful, the existing calibration data will not be changed. A screen will appear identifying the error (high slope, low slope, or offset error). For troubleshooting see section 9.6.

14. To return to the main display, press MENU then EXIT.

6.4.5 Procedure-Standardization

1. The pH value measured by the analyzer can be changed to match the reading from a second or referee instrument. The process of making the two readings agree is called standardization.
2. Place the sensor in the flow cell. Wait until pH readings are stable.

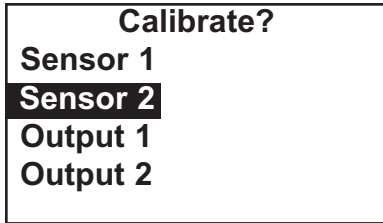

3. Press MENU. The main menu screen appears. The cursor will be on **Calibrate**. Press ENTER.
4. Choose the sensor you wish to calibrate. **Sensor 1** is the chlorine sensor. **Sensor 2** is the pH sensor.

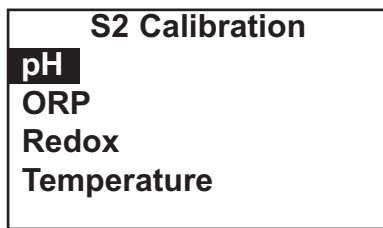

5. Choose **pH**.

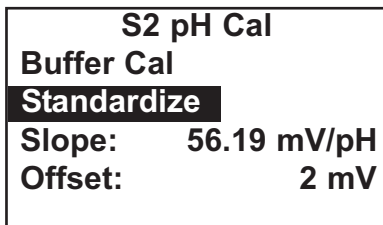

6. Choose **Standardize**.

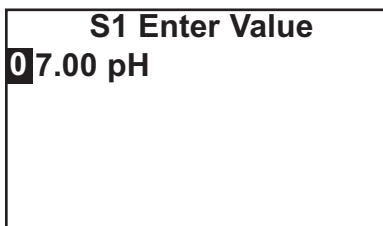

7. Once reading is stable, measure the pH of the liquid using a referee instrument. Because the pH of many natural and treated waters depends on temperature, measure the pH of the sample immediately after taking it. For poorly buffered samples determine the pH of a continuously flowing sample from a point as close as possible to the sensor.

Change the reading to match the reading of the referee instrument.

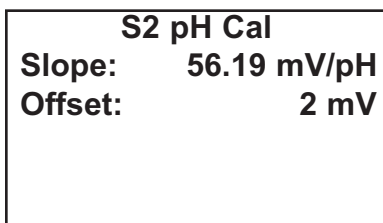

8. If the calibration is successful, the screen at left will be displayed for five seconds. The display will then return to screen in step 3.

If the calibration is not successful, the existing calibration data will not be changed. A screen will appear identifying the error (high slope, low slope, or offset error). For troubleshooting see section 9.5.

9. To return to the main display, press MENU then EXIT.

**6.4.6 Procedure-Entering a Known Slope and Offset**

1. Calibration data, i.e., slope and offset at pH 7, can be entered directly into the analyzer if the data for the sensor are already known.

```

Calibrate?
Sensor 1
Sensor 2
Output 1
Output 2
  
```

2. Press MENU. The main menu screen appears. The cursor will be on **Calibrate**. Press ENTER.

3. Choose the sensor you wish to calibrate. **Sensor 1** is the chlorine sensor. **Sensor 2** is the pH sensor.

```

S2 Calibration
pH
ORP
Redox
Temperature
  
```

4. Choose pH.

```

S2 pH Cal
Buffer Cal
Standardize
Slope: 56.19 mV/pH
Offset: 2 mV
  
```

5. Choose **Slope** or **Offset**. Enter the known slope and offset values. Always enter the slope as a positive number. Press ENTER to store the number. See Section 6.4.2 for more information.

6. To return to the main display, press MENU then EXIT.

## 6.5 CALIBRATION – Analog Outputs

### 6.5.1 Purpose

Although the analyzer analog outputs are calibrated at the factory, they can be trimmed in the field to match the reading from a standard milliammeter. Both the low (0 or 4 mA) and high (20 mA) outputs can be trimmed.

### 6.5.2 Procedure

1. Connect a calibrated milliammeter across the output you wish to calibrate. If a load is already connected to the output, disconnect the load. Do not put the milliammeter in parallel with the load.

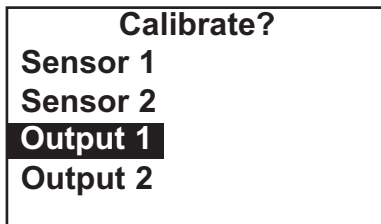

2. Press MENU. The main menu screen appears. The cursor will be on **Calibrate**. Press ENTER.
3. Choose the output you wish to calibrate.

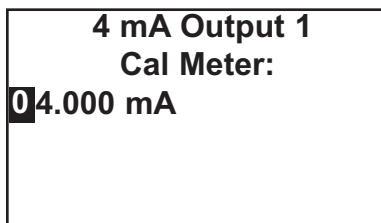

4. The analyzer will simulate the low output current. Change the value in the display to match the reading from the milliammeter.

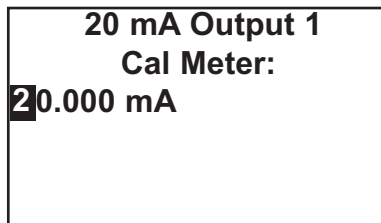

5. The analyzer will simulate the 20 mA output current. Change the value in the display to match the reading from the milliammeter.

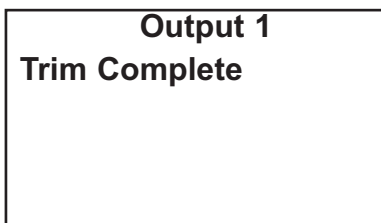

6. If the calibration was successful, the screen at left will appear.

7. If the user entered value is more that  $\pm 1$  mA different from the nominal value, a possible error screen will appear. To force the analyzer to accept the calibration, choose **Yes**.

8. To return to the main display, press MENU then EXIT.



## **SECTION 7.0 DIGITAL COMMUNICATIONS**

**THE ANALYZER SUPPLIED WITH THE FCLi DOES NOT HAVE THE DIGITAL  
COMMUNICATIONS OPTION.**



## SECTION 8.0 MAINTENANCE

### 8.1 ANALYZER

The analyzer used with the FCLi needs little routine maintenance.

Clean the analyzer case and front panel by wiping with a clean soft cloth dampened with water **ONLY**. Do not use solvents, like alcohol, that might cause a buildup of static charge.

Sensor circuit boards are replaceable.

PN	
24207-00	pH/ORP/ISE sensor board
24203-01	chlorine sensor board

To replace a board

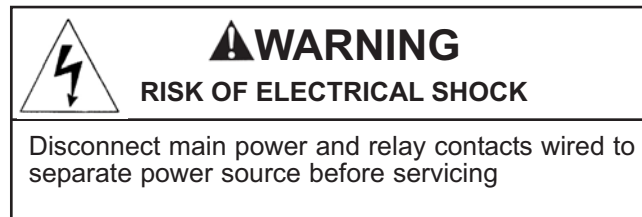

1. Turn off power to the analyzer.
2. Loosen the four screws holding the front panel in place and let the front panel drop down.
3. Loosen the gland fitting and carefully push the sensor cable up through the fitting as you pull out the circuit board.
4. Once you have access to the terminal strip, disconnect the sensor.
5. Unplug the sensor board from the main board. See Figure 3-2.
6. Slide the replacement board partially into the board slot. Plug the sensor board into the main board and reattach the sensor wires.
7. Carefully pull the sensor cable through the gland fitting as you push the sensor board back into the enclosure. Tighten the table glands.
8. Close the front panel.
9. Turn on power.

## 8.2 CHLORINE SENSOR

### 8.2.1 General.

When used in clean water, the 498CL-01 chlorine sensor requires little maintenance. Generally, the sensor needs maintenance when the response becomes sluggish or noisy or when readings drift following calibration. For a sensor used in potable water, expect to clean the membrane every month and replace the membrane and electrolyte slurry every three months. In water containing large amounts of suspended solids, for example open recirculating cooling water, membrane cleaning or replacement will be more frequent. Actual cleaning frequency can be determined only by experience.

### 8.2.2 Cleaning the membrane.

Clean the membrane with water sprayed from a wash bottle. **Do not use tissues to clean the membrane.** Pressing on the membrane may damage the mesh cathode.

### 8.2.3 Replacing the electrolyte solution and membrane.

 **CAUTION**

**Fill solution and solid may cause irritation. Avoid contact with skin and eyes. May be harmful if swallowed. Read and follow manual.**

1. Unscrew the membrane retainer and remove the membrane assembly and O-ring. See Figure 8-1.
2. Remove the fill plug.
3. Empty all remaining fill slurry from the sensor. Rinse with deionized water until there is no significant amount of solid left in the sensor.
4. Place a few drops of water in the replacement membrane assembly and place it on the mesh cathode. **DO NOT TOUCH THE MESH CATHODE.** Doing so may bend the mesh and permanently damage the sensor. Screw the membrane retainer into place.
5. Obtain one bottle of saturated succinic acid (PN 9210381, 40 mL) and one bottle of succinic acid crystals (PN 9210379, 40 g) from the electrolyte kit. Remove the red cap from the fill spout on each bottle.
6. Using a razor blade or scissors, cut the fill spout on the bottle of succinic acid crystals just below the line on the spout.
7. Hold the sensor with the membrane end pointed slightly upward. Insert the spout of the bottle of succinic acid solution into the fill port. Squeeze the bottle until half of the solution has been transferred to the electrolyte chamber.
8. Pour the solid succinic acid crystals into the fill port. If the crystals accumulate in the fill hole, shake or tap the sensor gently to unblock the port.
9. Use the remainder of the succinic acid solution to rinse crystals adhering to the threads into the sensor. Keep adding solution until it overflows the fill port. Tap the sensor a few times to be sure no air bubbles are trapped in the sensor.
10. Screw the fill plug back into place until it is flush with the body.
11. Hold the sensor with the membrane end pointing down and give it a few shakes as though shaking down a fever thermometer. Shaking helps clear bubbles that might have become trapped behind the mesh cathode.
12. The sensor may require several hours operating at the polarizing voltage to equilibrate after the electrolyte has been replaced. **Be sure to put the sensor in a flowing, chlorinated sample for equilibration.**

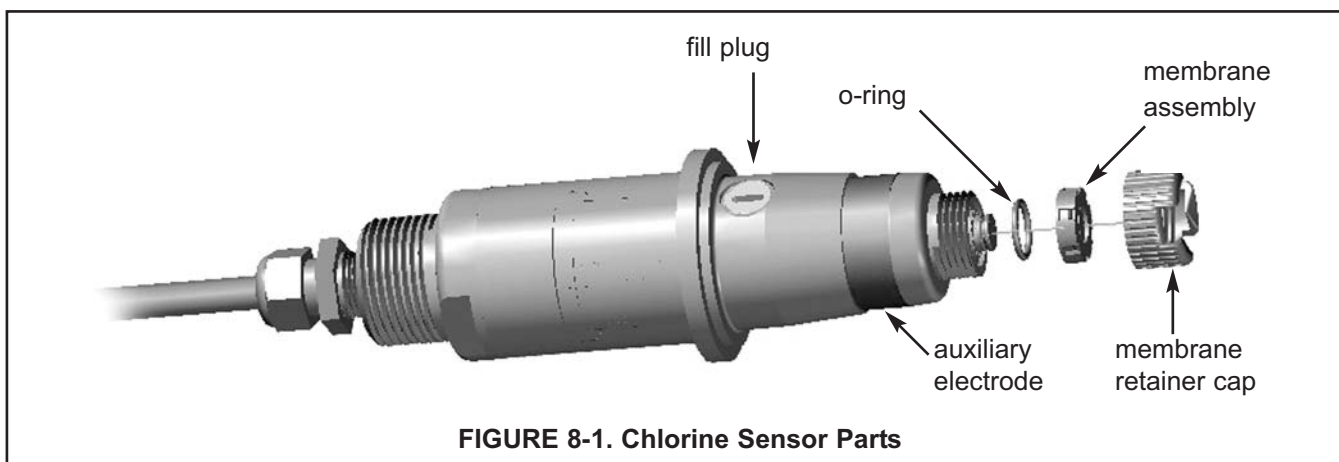

FIGURE 8-1. Chlorine Sensor Parts

**SPARE PARTS**

33970-00	Fill Plug
33968-00	Membrane retainer cap
23501-10	pH-independent free chlorine membrane assembly, includes one membrane assembly and O-ring
23502-10	pH-independent free chlorine membrane assembly, includes three membrane assemblies and O-rings
24146-00	pH-independent free chlorine sensor electrolyte kit, includes three bottles of saturated succinic acid solution and three bottles of succinic acid crystals

**8.2.4 Storage.**

The chlorine sensor is available in two styles. One has a copper auxiliary electrode; the other has a stainless steel auxiliary electrode. The auxiliary electrode is the metal band visible at the bottom of the sensor. The copper electrode is gradually being phased out and replaced by the stainless steel electrode.

The *copper-electrode sensor* can be damaged by long term exposure to a non-flowing sample. See section 6.3.2, step 2. However, it can tolerate loss of flow for up to four days as long as it remains in liquid in the flow cell with as little contact as possible between the liquid and air. There is a check valve in the sample inlet to prevent sample from draining out of the chlorine flow cell.

The *stainless steel-electrode sensor* can be kept for weeks or longer in a non-flowing sample as long as the sensor is not allowed to dry out.

For long term storage...

1. Turn off power to the analyzer.
2. Remove the sensor from the flow cell.
3. Replace the membrane with the shipping membrane provided with the sensor. For a replacement shipping membrane order PN 23501-00.
4. To protect the sensor from physical damage, store it in the **dry** flow cell.

**8.2.5 Rejuvenating a copper-electrode chlorine sensor following improper storage.**

If the copper electrode sensor is stored in a stagnant sample for an extended period, it can become contaminated with copper. Corrosion of the external copper electrode produces copper ions, which diffuse through the membrane into the sensor. If the sensor was powered up during storage, copper will plate out on the cathode. If the sensor was not powered up, the copper will start plating out as soon as the polarizing voltage is applied. As the copper plates out, the zero current increases. Once the copper has coated the cathode the sensitivity drops. The sensor will be unusable until the cathode has been cleaned.

1. If the sensor was not powered up during storage, **DO NOT APPLY POWER**. Empty the fill slurry and thoroughly rinse the sensor with deionized water. Refill the sensor with fresh fill slurry. Let the sensor run in **flowing** chlorinated water overnight. Zero and calibrate the sensor.

2. If the sensor was powered up during storage, the cathode is probably coated with metallic copper. **Disconnect the sensor from the analyzer.** Remove the membrane and clean out the fill slurry. Immerse the mesh cathode in 10% nitric acid solution (10 mL of concentrated nitric acid in 90 mL of water) for about five minutes. Rinse thoroughly with deionized water. Refill the sensor with fresh slurry and install a new membrane. Let the sensor run overnight in **flowing** chlorinated water. Zero and calibrate the sensor.

## 8.3 pH SENSOR

### 8.3.1 General.

When used in clean water, the pH sensor requires little maintenance. Generally, the sensor needs maintenance when the response becomes sluggish or noisy. In clean water the typical cleaning frequency is once a month. In water containing large amounts of suspended solids, for example open recirculating cooling water, cleaning frequency will be substantially greater.

### 8.3.2 Cleaning the Sensor

Remove soft deposits by rinsing with a stream of water from a wash bottle. If the sensor becomes coated with rust, dissolve the rust by soaking the sensor in dilute citric acid (dissolve 5 grams of citric acid crystals in 100 mL of water) for no longer than 30 minutes at room temperature. Rinse the sensor thoroughly with water and soak in pH 4 buffer for several hours. Recalibrate the sensor in buffers before returning it to service.

### 8.3.3 Other Maintenance

The 3900VP-02-10 pH sensor supplied with the Model FCLi-02 is disposable. It has no replaceable parts.

## 8.4 CONSTANT HEAD FLOW CONTROLLER

### 8.4.1 General

After a period of time, deposits may accumulate in the constant head overflow chamber and in the tubing leading to the flow cell(s). Deposits increase the resistance to flow and cause the flow to gradually decrease. Loss of flow may ultimately have an impact on the chlorine sensor performance. The flow controller is designed to provide about 1.2 gal/hr (75 mL/mm) flow. Loss of flow to about 0.5 gal/hr (30 mL/mm) causes about a 5% decrease in chlorine sensor output. Loss of flow has almost no effect on pH sensor performance other than to increase the overall response time of the sensor.

### 8.4.2 Cleaning the flow controller

The low flow controller can be taken apart completely for cleaning. Use a strong flow of water to flush out the tubing. A pipe cleaner or a small bottlebrush can remove more adherent deposits. To prevent leaks, apply a thin layer of silicone grease (or equivalent) to the two O-rings at the base of overflow chamber and to the O-ring sealing the central overflow tube to the base.

### 8.4.3 Other Maintenance

Table 8-2 and Figure 8-2 show the replacement parts for the flow controller assembly used in Model FCLi-01. Table 8-3 and Figure 8-3 show replacement parts for the flow controller assembly used in Model FCLi-02.

**TABLE 8-2. Replacement parts for constant head flow controller assembly (Model FCLi-01)**

Location in Figure 8-2	PN	Description	Shipping Weight
1	24039-00	Flow cell for chlorine sensor with bubble shedding nozzle <sup>1</sup>	1 lb/0.5 kg
2	24040-00	O-ring kit, two 2-222 and one 2-024 silicone O-rings, with lubricant	1 lb/0.5 kg
3	33812-00	Dust cap for constant head flow controller	1 lb/0.5 kg
4	9322032	Elbow, ¼ in FNPT x ¼ in OD tubing	1 lb/0.5 kg
5	9350029	Check valve, ¼ in FNPT	1 lb/0.5 kg
6	33823-00	Outside tube for constant head device	1 lb/0.5 kg

<sup>1</sup>The replacement flow cell (item 1) is used in other products. It includes a clear plastic adapter with 1-inch FPT. The adapter is not used in the FCLi.

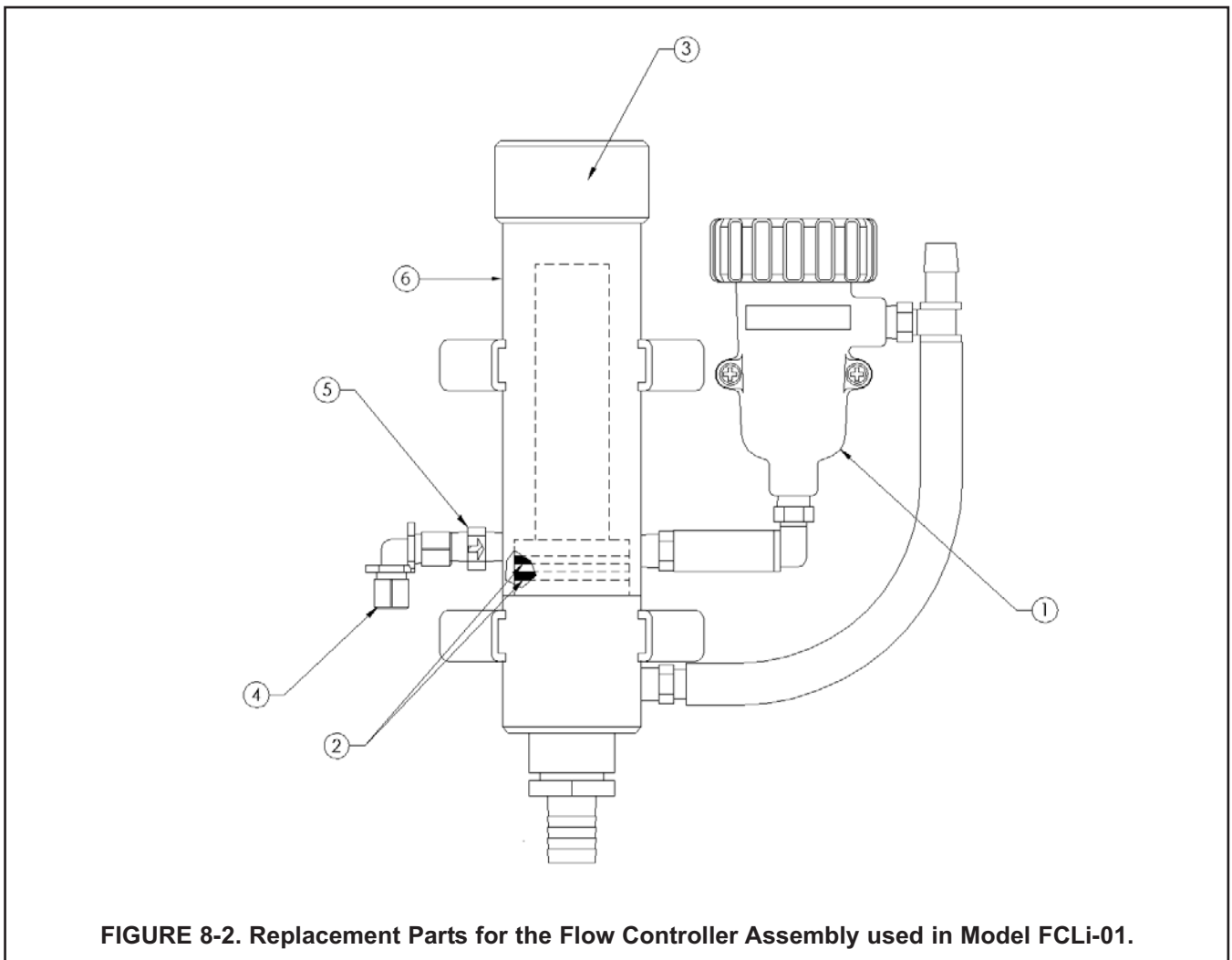

**TABLE 8-3. Replacement parts for constant head flow controller assembly (Model FCLi-02)**

Location in Figure 8-3	PN	Description	Shipping Weight
1	24039-00	Flow cell for chlorine sensor with bubble shedding nozzle <sup>1</sup>	1 lb/0.5 kg
2	24039-01	Flow cell for pH sensor	1 lb/0.5 kg
3	24040-00	O-ring kit, two 2-222 and one 2-024 silicone O-rings, with lubricant	1 lb/0.5 kg
4	33812-00	Dust cap for constant head flow controller	1 lb/0.5 kg
5	9322032	Elbow, ¼ in FNPT x ¼ in OD tubing	1 lb/0.5 kg
6	9350029	Check valve, ¼ in FNPT	1 lb/0.5 kg
7	33823-00	Outside tube for constant head device	1 lb/0.5 kg

<sup>1</sup>The replacement flow cell (item 1) is used in other products. It includes a clear plastic adapter with 1-inch FPT. The adapter is not used in the FCLi.

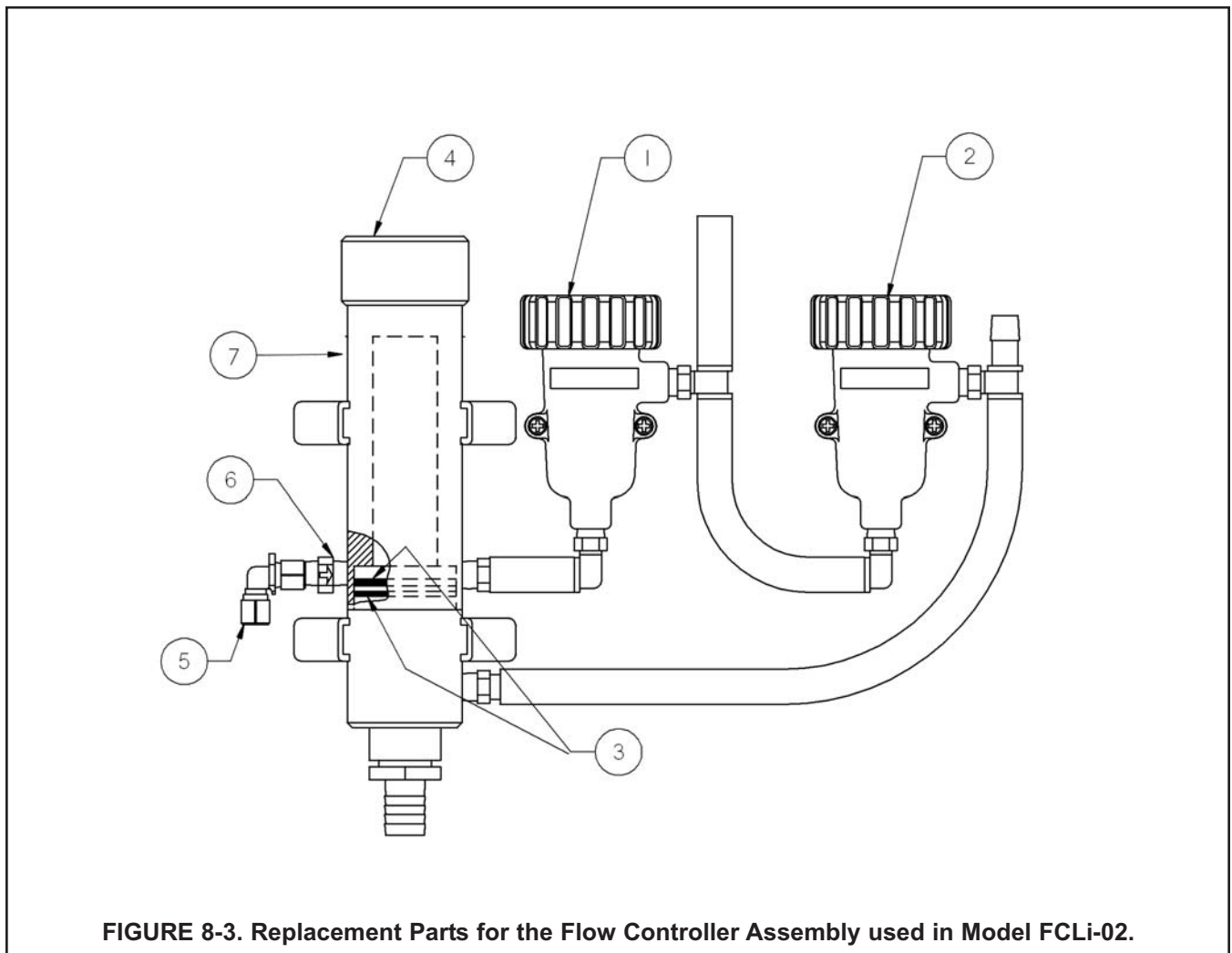

# SECTION 9.0

## TROUBLESHOOTING

### 9.1 OVERVIEW

The analyzer continuously monitors itself and the sensor(s) for problems. When the analyzer identifies a problem, the word **warning** or **fault** appears intermittently in the lower line of the main display. When the **fault** or **warning** message appears, press the DIAG (diagnostic) key for more information. See Section 9.2.

A **warning** means the instrument or sensor is usable, but steps should be taken as soon as possible to correct the condition causing the warning.

A **fault** means the measurement is seriously in error and is not to be trusted. A fault condition might also mean that the analyzer has failed. Fault conditions must be corrected immediately. When a fault occurs the analog output goes to 22.00 mA or to the value programmed in Section 5.3.2.

The analyzer also displays warning messages if a calibration is seriously in error. For more information see Section 9.6.

### 9.2 USING THE DIAGNOSTIC FEATURE

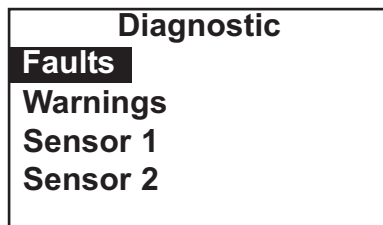

1. To read diagnostic messages, press DIAG. The screen at left appears. To display fault messages, select **Fault**. To display **Warning** messages select warning. To read measurement information about the sensor(s) including raw sensor signal and calibration data, choose the desired sensor and press ENTER.

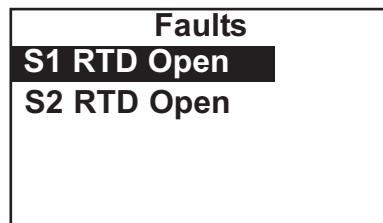

2. If you choose **Fault** or **Warning**, a screen like the one shown at left appears. **S1** means sensor 1. **S2** means sensor 2. For additional troubleshooting information, select the desired message and press ENTER. For more information, see Section 9.3.
3. To return to the main display, press MENU then EXIT

**9.3 TROUBLESHOOTING WHEN A FAULT MESSAGE IS SHOWING**

<b>Fault message</b>	<b>Explanation</b>	<b>Section</b>
Main Board CPU Error	Main board software is corrupted	9.3.1
Main Board Factory Data	Main board factory eeprom data is corrupted	9.3.1
Main Board User Data	Main board user eeprom data is corrupted	9.3.1
Sensor Hardware Error	Missing or bad hardware component	9.3.2
Sensor Board Unknown	Analyzer does not recognize sensor board	9.3.3
Sensor HW-SW Mismatch	Sensor board hardware and software do not match	9.3.3
Sensor Incompatible	Sensor board software is not supported by main board software	9.3.4
Sensor Not Communicating	Sensor board is not communicating with main board	9.3.3
Sensor CPU Error	Sensor board software is corrupted	9.3.5
Sensor RTD Open	Temperature measuring circuit is open	9.3.6
S1 Not Detected	No sensor board is connected to sensor 1 terminal	9.3.7
Sensor Factory Data	Sensor board factory eeprom data is corrupted	9.3.8
Sensor EEPROM Write Error	Bad CPU on the sensor board	9.3.8
Sensor User Data	Sensor board user eeprom data is corrupted	9.3.8
Sensor ADC Error	Bad component on the sensor board	9.3.9
Sensor RTD Out of Range	RTD is improperly wired or has failed	9.3.10
Sensor Glass Z Too High	The impedance of the <b>pH</b> sensing glass membrane is too high.	9.3.11
Sensor Broken Glass	The impedance of the <b>pH</b> sensing glass membrane is very low, suggesting a broken glass membrane	9.3.12

**9.3.1 Main Board CPU, Main Board Factory Data, and Main Board User Data Errors.**

These error messages mean the main board software is corrupted or the eeprom data on the main board is corrupted.

1. Cycle the power off then on.
2. If cycling the power does not help, call the factory. The main board must be replaced. To do this, the analyzer must be returned to the factory.
3. If cycling the power does not help **and the fault message was Main Board User Data**, reset the analyzer to factory default and re-enter user settings and repeat calibration.

**9.3.2 Hardware Error.**

Hardware error means there is a missing or bad hardware component on the sensor board. The board must be replaced.

**9.3.3 Sensor Board Unknown, Sensor Board HW (Hardware) or SW (Software) Mismatch, or Sensor Board Not Communicating.**

These error messages mean the main board either does not recognize the sensor board or the sensor board and main board are no longer communicating.

1. Verify that the ribbon cable connecting the main board (on the inside of the front panel) and the sensor board are properly seated. Inspect the connecting cable for obvious tears or breaks.
2. If the ribbon cable is properly seated and appears undamaged, the sensor board should be replaced.

### 9.3.4 Sensor Incompatible

This error message means that the sensor board software is not supported by the main board software. Either the sensor board or the main board software is too old.

Replace the main board with one compatible with the sensor board. Call the factory for assistance. You will be asked for the main and sensor board software revision numbers. To read the main board software revision, press the DIAG key and scroll down until **Instr SW Ver** is showing. To view the sensor board software revision, press the DIAG key, choose the appropriate sensor, and scroll down until **Board SW Ver** is showing. The main board can be replaced only at the factory.

### 9.3.5 Sensor CPU Error

This message means the sensor board software is corrupted.

1. Cycle the power off then on.
2. If cycling the power does not help, call the factory. The sensor board must be replaced.

### 9.3.6 Sensor RTD Open

The chlorine and pH sensors used in the FCLi contain a Pt 100 RTD (resistance temperature device) for measuring temperature. Sensor RTD open means the temperature measuring circuit is open.

1. Confirm that the sensor RTD wires are properly connected.
2. Confirm that the Variopol connector is properly seated.
3. Disconnect the sensor from the cable and use an ohmmeter to check the resistance across the RTD. See Figures 9-1 and 9-2. At room temperature it should be about 110 $\Omega$ . If the resistance is very high, the RTD has failed and the sensor must be replaced. If the resistance is okay, connect the Variopol cable to the sensor and disconnect the three RTD wires at the analyzer. Measure the resistance across the RTD leads, which are red and white. See Figure 9.4. If the resistance is very high, the problem is with the VP cable, and it must be replaced.

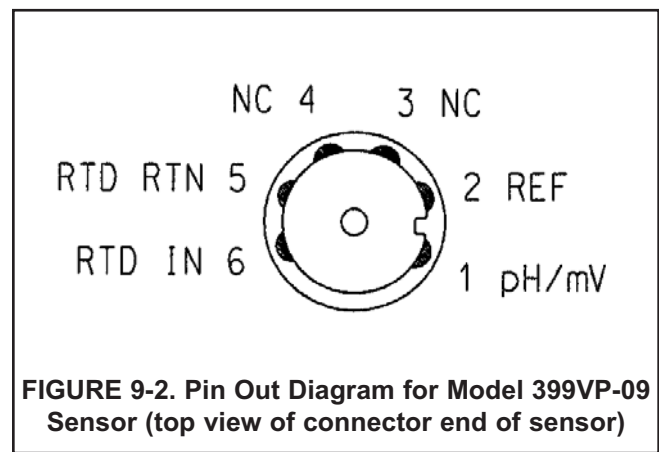
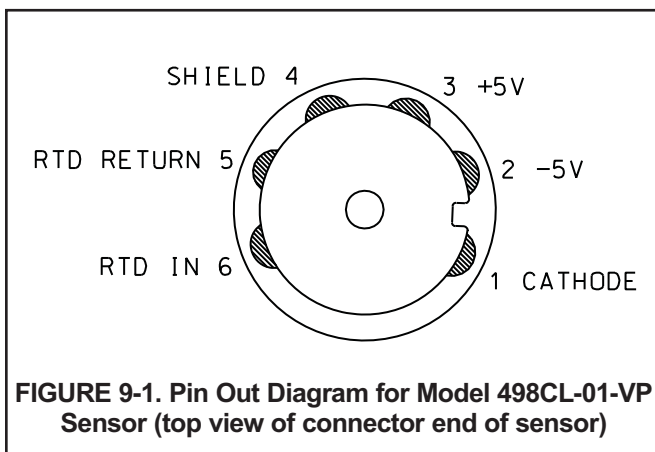

### 9.3.7 Sensor 1 Not Detected

The ribbon cable from sensor 1 (chlorine) board must be plugged into the sensor 1 plug. See Figure 3-2 for the location of the sensor board connectors.

1. Confirm that the ribbon cable connecting sensor 1 (chlorine) board to the main board is plugged into the Sensor 1 connector on the main board.
2. Confirm that the ribbon cable is seated at both ends.

### 9.3.8 Sensor Factory Data, Sensor Board User Data, and Sensor EEPROM Write Error

These messages mean factory eeprom data or user eeprom data on the sensor board is corrupted or the CPU on the sensor board is bad.

1. Cycle power off then on.
2. Replace the sensor board.

### 9.3.9 Sensor ADC Error

There is a bad component on the sensor board. The sensor board must be replaced.

**9.3.10 Sensor RTD Out of Range**

Both the chlorine and pH sensor contain a Pt 100 RTD (resistance temperature device) for measuring temperature. If the measured resistance is outside the expected range, the analyzer will display the out of range error message.

1. Check wiring connections.
2. Disconnect the sensor from the cable and use an ohmmeter to check the resistance across the RTD. See Figures 9-1 and 9-2. The resistance should be about 110  $\Omega$ . If there is an open or short circuit, the sensor has failed and should be replaced. If the resistance is acceptable, attach the sensor to the Variopol cable and disconnect the RTD IN and RTD RTN leads at the analyzer. Connect an ohmmeter across the leads and measure the resistance. If the circuit is open or shorted, the cable must be replaced.
3. If there is no open or short, check the analyzer. See Section 9.10.2.

**9.3.11 Glass Z Too High**

The sensing element in the pH sensor is a thin glass membrane. Normally, the impedance of the glass membrane is about 80-100 M $\Omega$ . As the glass membrane ages, the impedance increases. A large increase in glass impedance suggests that the sensor is near the end of its useful life.

**9.3.12 Broken Glass**

The sensing element in the pH sensor is a thin glass membrane. Normally, the impedance of the glass membrane is about 80-100 M $\Omega$ . If the glass membrane gets broken or cracked, the impedance will drop to less than 10 M $\Omega$ .

1. Check sensor settings under the Measurement submenu. Confirm that the pre-amplifier location is set to "analyzer".
2. Confirm that the pH sensor is installed in the flow cell and sample is flowing through the cell.
3. Check the sensor response in two buffers having different pH values. If the membrane is cracked or broken, the pH reading will be about the same in both buffers.
4. Replace the pH sensor.

## 9.4 TROUBLESHOOTING WHEN A WARNING MESSAGE IS SHOWING

Warning message	Explanation	Section
Sensor No Solution Gnd	pH sensor may be miswired.	9.4.1
Sensor Need Factory Cal	The sensor board was not calibrated at the factory.	9.4.2
Sensor Out of Range	The pH measurement is invalid.	9.4.3
Sensor Negative Reading	The chlorine reading is less than -0.5 ppm.	9.4.4
Sensor RTD Sense Open	RTD sensor line is broken or not connected	9.4.5
Sensor Temperature High	Temperature is greater than 155°C (311°F)	9.4.6
Sensor Temperature Low	Temperature is less than -20°C (-4°F)	9.4.6
Broken Glass Disabled	Advisory only (applies to pH sensor only)	9.4.7

### 9.4.1 Sensor No Solution Gnd

This message implies that the pH sensor is miswired. Check sensor wiring.

### 9.4.2 Sensor Need Factory Cal

The sensor board was improperly calibrated at the factory. Call the factory for assistance.

### 9.4.3 Sensor Out of Range

This warning message applies to the pH sensor only. It appears when the raw signal from the pH sensor is greatly outside the range expected for a properly operating sensor.

1. Confirm that the pH sensor is plugged into the VP cable labeled pH sensor.
2. Check wiring in the analyzer.
3. Replace the pH sensor.

### 9.4.4 Sensor Negative Reading

The message applies to the chlorine sensor only. The analyzer converts the raw sensor current to ppm chlorine by subtracting the zero current from the raw current and multiplying the result by a conversion factor. If the zero current is larger than the raw current, the result will be negative.

1. Check the zero current. It should be less than about 100 nA. If it is greater than 100 nA, repeat the zero step.
2. If the zero current is in the correct range, the negative reading might be the result of the raw current or the sensitivity being too low. A properly operating sensor should generate between 400 and 1000 nA for every 1 ppm free chlorine. Recalibrate the sensor. If necessary, clean or replace the membrane and check the fill slurry.
3. Replace the sensor.

### 9.4.5 Sensor RTD Sense Open

The analyzer measures temperature using a three-wire RTD. See Figure 9.4. The in and return leads are used to measure the resistance of the RTD. The third lead, called the sense line, is connected to the return lead at the sensor. The sense line allows the analyzer to correct for the resistance of the in and return leads and to compensate for changes in lead resistance caused by changes in ambient temperature.

1. Check sensor wiring, particularly the red, white, and white/red RTD leads.
2. Disconnect the sense and return leads and measure the resistance between the sense and return leads. It should be less than 1Ω. See Figure 9.4.
3. Even though the sense line is open, the sensor is still usable. Use a wire jumper to connect the sense and return terminals on the sensor terminal strip. The temperature reading will no longer be corrected for the lead resistance, nor will the analyzer be able to compensate for changes in ambient temperature. The error could be several °C or more.
4. Replace the sensor.

**9.4.6 Sensor Temperature High or Low**

The sensor RTD is most likely miswired.

1. Check wiring connections.
2. Check resistance between RTD in and return leads. The resistance should be close to the values given in Section 9.10.2.
3. Replace sensor.

**9.4.7 Broken Glass Disabled**

The impedance of the pH glass electrode is a strong function of temperature. As temperature increases, the glass impedance decreases. Because the broken glass fault message appears when the glass impedance becomes too low, it is important that low impedance readings be properly corrected for temperature effects. However, there is a high temperature cutoff beyond which the correction does not work. Once the temperature exceeds this value, the broken glass fault is automatically disabled.

**This warning should never appear in the FCLi.**

**9.5 TROUBLESHOOTING WHEN NO ERROR MESSAGE IS SHOWING — CHLORINE**

<b>Problem</b>	<b>See Section</b>
Zero current was accepted, but the current is substantially greater than 100 nA	9.5.1
Error or warning message appears while zeroing the sensor (zero current is too high)	9.5.1
Zero current is unstable	9.5.2
Sensor can be calibrated, but sensitivity is significantly different from 500 nA/ppm	9.5.3
Process readings are erratic	9.5.4
Readings drift	9.5.5
Sensor does not respond to changes in chlorine level	9.5.6
Chlorine readings are too low	9.5.7

**9.5.1 Zero current is too high**

1. Is the sensor properly wired to the analyzer? See Section 3.2.
2. Is the zero solution chlorine-free? Take a sample of the solution and test it for free chlorine. The concentration should be less than 0.02 ppm.
3. Has adequate time been allowed for the sensor to reach a stable zero current? Normally, after a sensor has run in **chlorinated** water for about two hours, it will reach a low stable zero (<100 nA) current after about 30 minutes in **chlorine-free** water. If the zero current is not stable or is still high after 30 minutes, return the sensor to flowing chlorinated water and let it run longer before zeroing.
4. Check the membrane for damage and replace it if necessary.
5. Is the cathode coated with copper? (Applies only to chlorine sensors with a copper auxiliary electrode. The auxiliary electrode is the metal band at the bottom of the electrode. See figure 8-1.) If the 498CL-01 sensor is allowed to operate in a non-flowing sample **exposed to air** for more than about a day, copper from the corrosion of the copper auxiliary electrode can diffuse into the sensor and plate out on the cathode. As the copper plates out, the zero current becomes very high. Once the copper has coated the cathode, the sensitivity drops. Clean the cathode by soaking in dilute nitric acid. See Section 8.2.5 for details

**9.5.2 Zero current is unstable**

1. Is the sensor properly wired to the analyzer? See Section 3.2. Verify that all wiring connections are tight.
2. Readings are often erratic when a new or rebuilt sensor is first placed in service. Readings usually stabilize after about an hour.
3. Is the space between the membrane and cathode filled with electrolyte solution? The sensor has a gold mesh cathode that allows the fill solution to completely bathe the cathode. Sometimes air bubbles prevent the fill solution from contacting the entire mesh. The air bubbles can usually be cleared by holding the sensor with the membrane end pointing down and sharply shaking the sensor a few times as though shaking down a clinical thermometer.
4. Verify the sensor is filled with electrolyte slurry. Refer to Section 8.2.

**9.5.3 Sensor can be calibrated, but the current is too low**

1. Is the temperature low? The sensor current decreases about 3% for every °C drop in temperature.
2. Sensor current depends on the rate of sample flow past the sensor tip. If the flow is too low, chlorine readings will be low. Verify that the chlorine sensor is installed in the correct flow cell. See Figures 2-2 and 2-3. Be sure the liquid level in the constant head sampler is level with the central overflow tube and that excess sample is flowing down the tube. If necessary, disassemble and clean the overflow sampler. See Section 8.4.
3. Low current can be caused by lack of electrolyte flow to the cathode and membrane. See step 3 in Section 9.5.2.
4. Is the membrane fouled or coated? A dirty membrane inhibits diffusion of free chlorine through the membrane, reducing the sensor current and increasing the response time. Clean the membrane by rinsing it with a stream of water from a wash bottle. DO NOT use a tissue to wipe the membrane. Pressing on the membrane may damage the mesh cathode.
5. If cleaning the membrane does not improve the sensor response, replace the membrane and electrolyte solution. See Section 8.2 for details.

**9.5.4 Process readings are erratic**

1. Readings are often erratic when a new or rebuilt sensor is first placed in service. The current usually stabilizes after a few hours.
2. Is the fill solution making good contact with the cathode? Refer to Section 9.5.2.
3. Verify that wiring is correct. Pay particular attention to shield and ground connections.
4. Is the membrane in good condition and is the sensor filled with electrolyte solution? Replace the fill slurry. Refer to Section 8.2 for details.

**9.5.5 Readings drift**

1. Is the sample temperature changing? Membrane permeability is a function of temperature. The time constant for the 498CL-01 sensor is about five minutes. Therefore, the reading may drift for a while after a sudden temperature change.
2. Is the membrane clean? For the sensor to work properly, chlorine must diffuse freely through the membrane. A coating on the membrane will interfere with the passage of chlorine, resulting in slow response. Clean the membrane by rinsing it with a stream of water from a wash bottle. **DO NOT** use a membrane or tissue to wipe the membrane.
3. Is the sample flow within the recommended range? Gradual loss of sample flow will cause a downward drift. Be sure the liquid level in the constant head sampler is level with the central overflow tube and that excess sample is flowing down the tube. If necessary, disassemble and clean the overflow sampler. See Section 8.4.
4. Is the sensor new or has it been recently serviced? New or rebuilt sensors may require several hours to stabilize.
5. Is a bubble trapped against the membrane? For the sensor to work properly, the chlorine must continuously diffuse through the membrane. Bubbles block the chlorine in the sample from reaching the membrane, so readings drift downward as bubbles form and grow. The nozzle at the bottom of the flow cell pushes bubbles to the edges of the membrane where they do no harm. In cold samples the nozzle may not be as effective.
  - a. If bubbles are visible, confirm that they are blocking the membrane by removing the sensor from the flow cell and replacing it. Removing the sensor breaks the bubbles, so when the sensor is replaced, readings return to normal.
  - b. Confirm that the nozzle is properly positioned in the flow cell. Line up your eye with the bottom of the membrane retainer. No gap should be visible between the end of the nozzle and membrane retainer.

**9.5.6 Sensor does not respond to changes in chlorine level.**

1. Is the grab sample test accurate? Is the grab sample representative of the sample flowing to the sensor?
2. Is sample flowing past the sensor? Be sure the liquid level in the constant head flow controller is level with the central overflow tube and that excess sample is flowing down the tube. If necessary, disassemble and clean the overflow sampler. See Section 8.4.
3. Is the membrane clean? Clean the membrane with a stream of deionized water. DO NOT use a tissue to wipe the membrane. Pressing on the membrane may damage the mesh cathode.
4. Is the fill solution making good contact with the cathode? Hold the sensor with the membrane end pointing down and give it a few sharp shakes to force electrolyte between the cathode and membrane.
5. Replace the electrolyte slurry.
6. Replace the sensor.

**9.5.7 Chlorine readings are too low.**

1. Was the comparison grab sample tested as soon as it was taken? Chlorine solutions are unstable. Test the sample immediately after collecting it. Avoid exposing the sample to sunlight.
2. Low readings can be caused by zeroing the sensor before the zero current has reached a stable minimum value. Zero current is the current the sensor generates even when no chlorine is in the sample. Because the zero current is subtracted from subsequent measured currents, zeroing before the current is a minimum can lead to low results.  
Example: The true zero current for the chlorine sensor is 50 nA, and the sensitivity is 500 nA/ppm. Assume the measured current is 200 nA. The true concentration is  $(200-50)/500$  or 0.30 ppm. If the sensor was zeroed prematurely when the current was 100 nA, the measured concentration will be  $(200-100)/500$  or 0.20 ppm. The error is 33%. Suppose the measured current is 400 nA. The true concentration is 0.70 ppm, and the measured concentration (assuming the sensor was zeroed at 100 nA) is 0.60 ppm. The error is now 14%. The absolute difference between the readings remains the same, 0.10 ppm.
3. Sensor response depends on flow. Verify that the chlorine sensor is installed in the correct flow cell. See Figures 2-2 and 2-3. Verify that the liquid level in the constant head sampler is level with the central overflow tube and that excess sample is flowing down the tube. If necessary, disassemble and clean the overflow sampler. See Section 8.4.

**9.6 TROUBLESHOOTING WHEN NO ERROR MESSAGE IS SHOWING — pH.**

<b>Problem</b>	<b>See Section</b>
Calibration Error warning during two-point calibration	9.6.1
Offset Error warning during standardization	9.6.2
Sensor does not respond to known pH changes	9.6.3
Calibration was successful, but process pH is slightly different from expected value	9.6.4
Calibration was successful, but process pH is grossly wrong and/or noisy	9.6.5
pH readings are moderately noisy and tend to wander	9.6.6
pH is too low	9.6.7

**9.6.1 Calibration Error During Two-Point Calibration**

Once the two-point (manual or automatic) calibration is complete, the analyzer automatically calculates the sensor slope (at 25°). If the slope is greater than 60 mV/pH or less than 45 mV/pH, the analyzer displays the Calibration Error screen and does not update the calibration. Check the following:

1. Are the buffers accurate? Inspect the buffers for obvious signs of deterioration, such as turbidity or mold growth. Neutral and slightly acidic buffers are highly susceptible to molds. Alkaline buffers (pH 9 and greater), if they have been exposed to air for long periods, might also be inaccurate. Alkaline buffers absorb carbon dioxide from the atmosphere, which lowers the pH. If a high pH buffer was used in the failed calibration, repeat the calibration using a fresh buffer. If fresh buffer is not available, use a lower pH buffer. For example, use pH 4 and 7 buffer instead of pH 7 and 10 buffer.
2. Was adequate time allowed for temperature equilibration? If the sensor was in a process substantially hotter or colder than the buffer, place it in a container of water at ambient temperature for at least 20 minutes before starting the calibration. Using auto calibration helps avoid calibration errors caused by temperature drift. The analyzer will not update readings until the drift is less than 0.02 pH over 10 seconds.
3. Were correct pH values entered during manual calibration? Using auto calibration eliminates errors caused by improperly entering data.
4. Is the sensor properly wired to the analyzer? See Section 3.2.
5. Is the sensor dirty or coated? See Section 8.3.2.
6. Is the sensor faulty? Check the glass impedance. Press DIAG and choose Sensor 2. Glass impedance is the third item in the display. Refer to the table below for an interpretation of the impedance readings.

<b>GLASS IMPEDANCE (Glass Imp)</b>	
less than 10 MΩ	Glass bulb is cracked or broken. Sensor has failed.
between 10 and 1000 MΩ	Normal reading.
greater than 1000 MΩ	pH sensor may be nearing the end of its service life.

Another way of checking for a faulty sensor is to replace it with a new one. If the new sensor can be calibrated, the old sensor has failed.

7. Is the analyzer faulty? The best way to check for a faulty analyzer is to simulate pH inputs. See Section 9.9.

**9.6.2 Calibration Error during Standardization.**

During standardization, the millivolt signal from the pH cell is increased or decreased until the pH agrees with the pH reading from a referee instrument. A unit change in pH requires an offset of about 59 mV. The analyzer limits the offset to  $\pm 60$  mV. If the standardization causes an offset greater than  $\pm 60$  mV, the analyzer will display the Offset Error screen. The standardization will not be updated. Check the following:

1. Is the referee pH meter working and properly calibrated? Check the response of the referee sensor in buffers.
2. Is the sensor fully immersed in the process liquid? If the sensor is not completely submerged, it may be measuring the pH of the liquid film covering the glass bulb and reference element. The pH of this film may be different from the pH of the bulk liquid.
3. Is the sensor fouled? The sensor measures the pH of the liquid adjacent to the glass bulb. If the sensor is heavily fouled, the pH of liquid trapped against the bulb may be different from the bulk liquid.
4. Has the sensor been exposed to poisoning agents (sulfides or cyanides) or has it been exposed to extreme temperature? Poisoning agents and high temperature can shift the reference voltage many hundred millivolts.

**9.6.3 Sensor Does Not Respond to Known pH Changes.**

1. Is the pH sensor responsive to buffers? Check sensor response in two buffers at least two pH units apart.
2. Did the expected pH change really occur? Use a second pH meter to verify the change.
3. Is sample flowing past the sensor? Be sure the liquid level in the constant head sampler is level with the central overflow tube and that excess sample is flowing down the tube. If necessary, disassemble and clean the overflow sampler. See Section 8.4.
4. Is the sensor properly wired to the analyzer? See Section 3.2.
5. Is the glass bulb cracked or broken? Check the glass electrode impedance. See Section 9.6.2.
6. Is the analyzer working properly? Check the analyzer by simulating the pH input. See Section 9.9.

**9.6.4 Buffer Calibration Is Acceptable, Process pH Is Slightly Different from Expected Value.**

Differences between pH readings made with an on-line instrument and a laboratory or portable instrument are normal. The on-line instrument is subject to process variables, for example ground potentials, stray voltages, and orientation effects that may not affect the laboratory or portable instrument. To make the process reading agree with a referee instrument, see Section 6.4.5.

**9.6.5 Calibration Was Successful, but Process pH Is Grossly Wrong and/or Noisy.**

Grossly wrong or noisy readings suggest a ground loop (measurement system connected to earth ground at more than one point), a floating system (no earth ground), or noise being brought into the analyzer by the sensor cable. The problem arises from the process or installation. It is not a fault of the analyzer. The problem should disappear once the sensor is taken out of the system. Check the following:

1. Is a ground loop present?
  - a. Verify that the system works properly in buffers. Be sure there is no direct electrical connection between the buffer containers and the process liquid or piping.
  - b. Strip back the ends of a heavy gauge wire. Connect one end of the wire to the process piping or place it in the process liquid. Place the other end of the wire in the container of buffer with the sensor. The wire makes an electrical connection between the process and sensor.
  - c. If offsets and noise appear after making the connection, a ground loop exists.
2. Is the process grounded?
  - a. The measurement system needs one path to ground: through the process liquid and piping. Plastic piping, fiberglass tanks, and ungrounded or poorly grounded vessels do not provide a path. A floating system can pick up stray voltages from other electrical equipment.
  - b. Ground the piping or tank to a local earth ground.
  - c. If noise still persists, simple grounding is not the problem. Noise is probably being carried into the instrument through the sensor wiring.
3. Simplify the sensor wiring.
  - a. Disconnect all sensor wires at the analyzer except, IN REFERENCE, IN pH, RTD IN and RTD RETURN. See the wiring diagrams in Section 3.2.
  - b. Tape back the ends of the disconnected wires to keep them from making accidental connections with other wires or terminals.
  - c. Connect a jumper wire between the RTD RETURN and RTD SENSE terminals (see wiring diagrams in Section 3.2).
  - d. If noise and/or offsets disappear, the interference was coming into the analyzer through one of the sensor wires. The system can be operated permanently with the simplified wiring.
4. Check for extra ground connections or induced noise.
  - a. To avoid induced noise in the sensor cable, keep the unit as far away as possible from power cables, relays, and electric motors.
  - b. If ground loops persist, consult the factory. A visit from an experienced technician may be required to solve the problem.

**9.6.6 pH Readings Are Moderately Noisy and Tend to Wander.**

pH readings that are moderately noisy ( $\pm 0.1$  pH) and tend to wander are probably caused by bubbles getting trapped against the pH sensor. Although the overflow sampler is designed to allow bubbles to escape before they reach the pH sensor and the sensor itself is designed so trapped air bubbles don't interfere with the measurement, bubbles may occasionally be a problem. Shaking the sensor will dislodge the bubbles. If bubbles remain a problem, contact the factory.

**9.6.7 pH is too low.**

Verify that the pH sensor is installed upstream of the chlorine sensor. See Figure 2-3. The chlorine sensor continuously leaches acidic fill solution into the sample. Unless the sample has very high alkalinity, the acid will depress the pH.

### 9.7 TROUBLESHOOTING WHEN NO ERROR MESSAGE IS SHOWING — GENERAL

Problem	See Section
Difference between analyzer and standard thermometer greater than 3°C	9.7.1
Current output is too low	9.7.2
Alarm relays do not operate when setpoint is exceeded	9.7.3

#### 9.7.1 Difference Between Analyzer and Standard Thermometer is Greater Than 3°C.

1. Is the standard thermometer, RTD, or thermistor accurate? General purpose liquid-in-glass thermometers, particularly ones that have been mistreated, can have surprisingly large errors.
2. Is the temperature element in the pH sensor completely submerged in the test liquid?
3. Is the standard temperature sensor submerged to the correct level?
4. Review Section 6.2

#### 9.7.2 Current Output Too Low.

Load resistance is too high. Maximum load is 550 Ω.

#### 9.7.3 Alarm Relays Do Not Work

Verify the relays are properly wired.

### 9.8 SIMULATING INPUTS — CHLORINE

The input current of the sensor cannot be simulated.

### 9.9 SIMULATING INPUTS — pH

#### 9.9.1 General

This section describes how to simulate a pH input into the analyzer. To simulate a pH measurement, connect a standard millivolt source to the analyzer. If the analyzer is working properly, it will accurately measure the input voltage and convert it to pH.

#### 9.9.2 Simulating pH input.

1. Set automatic temperature correction to manual and set manual temperature to 25°C. Turn off solution temperature correction. See Section 5.6
2. Disconnect the sensor and connect a jumper wire between the IN REFERENCE and IN pH terminals.
3. Press DIAG and choose sensor 2 (pH). The input voltage should be 0 mV and the pH should be 7.00. Because calibration data stored in the analyzer may be offsetting the input voltage, the displayed pH may not be exactly 7.00.
4. If a standard millivolt source is available, disconnect the jumper wire between IN REFERENCE and IN pH and connect the voltage source as shown in Figure 9-3. Be sure to jumper the IN REFERENCE and GND SOL.
5. Calibrate the analyzer using the procedure in Section 6.3. Use 0.0 mV for Buffer 1 (pH 7.00) and -177.4 mV for Buffer 2 (pH 10.00). If the analyzer is working properly it should accept the calibration. The slope should be 59.16 mV/pH and the offset should be zero.
6. To check linearity, return to the main display and the pH/temperature/mV screen. Set the voltage source to the values shown in the table and verify that the pH and millivolt readings match the values in the table.

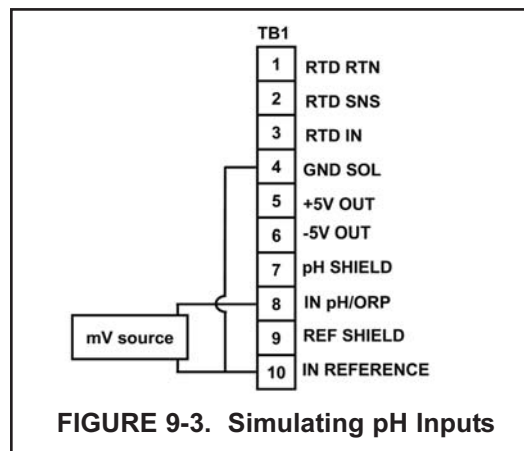

FIGURE 9-3. Simulating pH Inputs

Voltage (mV)	pH (at 25°)
295.8	2.00
177.5	4.00
59.2	6.00
-59.2	8.00
-177.5	10.00
-295.8	12.00

## 9.10 SIMULATING INPUTS — TEMPERATURE

### 9.10.1 General.

The analyzer accepts a Pt100 RTD (for pH and chlorine sensors). The Pt100 RTD is in a three-wire configuration. See Figure 9-4.

### 9.10.2 Simulating temperature

To simulate the temperature input, wire a decade box to the analyzer or junction box as shown in Figure 9-5.

To check the accuracy of the temperature measurement, set the resistor simulating the RTD to the values in the table and note the temperature readings. The measured temperature might not agree with the value in the table. During sensor calibration an offset might have been applied to make the measured temperature agree with a standard thermometer. The offset is also applied to the simulated resistance. The analyzer is measuring temperature correctly if the difference between measured temperatures equals the difference between the values in the table to within  $\pm 0.1^\circ\text{C}$ .

For example, start with a simulated resistance of  $103.9\ \Omega$ , which corresponds to  $10.0^\circ\text{C}$ . Assume the offset from the sensor calibration was  $-0.3\ \Omega$ . Because of the offset, the analyzer calculates temperature using  $103.6\ \Omega$ . The result is  $9.2^\circ\text{C}$ . Now change the resistance to  $107.8\ \Omega$ , which corresponds to  $20.0^\circ\text{C}$ . The analyzer uses  $107.5\ \Omega$  to calculate the temperature, so the display reads  $19.2^\circ\text{C}$ . Because the difference between the displayed temperatures ( $10.0^\circ\text{C}$ ) is the same as the difference between the simulated temperatures, the analyzer is working correctly.

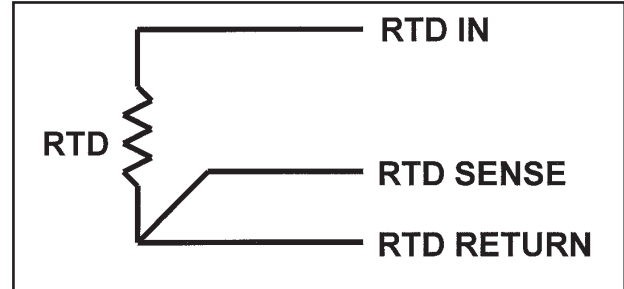

FIGURE 9-4. Three-Wire RTD Configuration.

Although only two wires are required to connect the RTD to the analyzer, using a third (and sometimes fourth) wire allows the analyzer to correct for the resistance of the lead wires and for changes in the lead wire resistance with temperature.

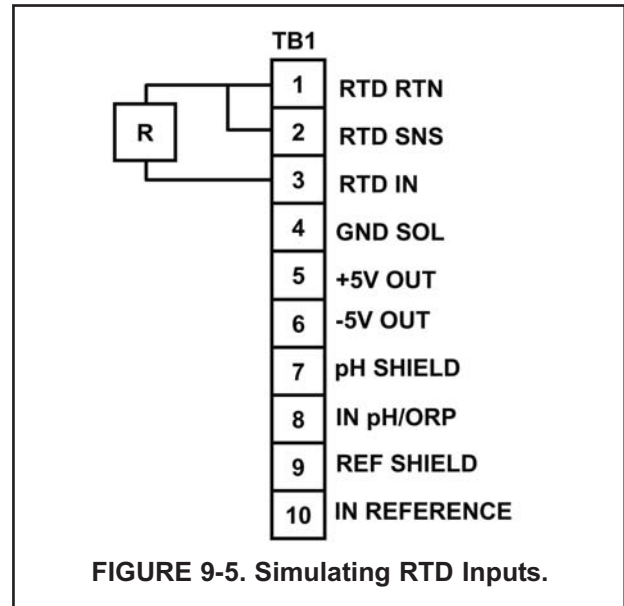

FIGURE 9-5. Simulating RTD Inputs.

Temp. ( $^\circ\text{C}$ )	Pt 100 ( $\Omega$ )
0	100.0
10	103.9
20	107.8
25	109.7
30	111.7
40	115.5
50	119.4
60	123.2
70	127.1
80	130.9
85	132.8
90	134.7
100	138.5

**The right people, the right answers, right now.**

## **Immediate, Reliable Analytical Support**

Now there's a way to quickly get the right answers for your liquid analytical instrumentation questions: the Analytical Customer Support Center.

Our staff of trained professionals is ready to provide the information you need. If you are placing an order, verifying delivery, requesting application information, or just want to contact a Rosemount Analytical representative, a call to the Customer Support Center will provide you with the right people, the right answers, right now.

## **A Worldwide Network of Sales and Service**

Emerson Process Management's field sales offices are your source for more information on the full line of Rosemount Analytical products. Field sales personnel will work closely with you to supply technical data and application information.

For more information, please contact your nearest Emerson Process Management sales office.

### **THE AMERICAS - HEADQUARTERS**

Emerson Process Management  
Rosemount Analytical Inc.  
Liquid Center of Excellence  
2400 Barranca Parkway  
Irvine, CA 92606  
Phone: +1.949.757.8500  
Toll Free: +1.800.854.8257  
Fax: +1.949.474.7250

### **GERMANY**

Emerson Process Management  
Process Gas Analyzer Center of  
Excellence  
GmbH & Co. OHG  
Industriestrasse 1  
63594 Hasselroth  
Germany  
T 49.6055.884.0  
F 49.6055.884.20

### **ASIA-PACIFIC**

Emerson Process Management  
Asia Pacific Private Ltd.  
1 Pandan Crescent  
Singapore 0512  
Republic of Singapore  
Phone: 65.777.8211  
Fax: 65.777.0947

### **LATIN AMERICA**

Emerson Process Management  
Rosemount Analytical  
10241 West Little York, Suite  
#200 Houston, TX 77040 USA  
T 713.467.6000  
F 713.827.3328

### **EUROPE**

Emerson Process Management  
Heath Place  
Bognor Regis  
West Sussex PO22 9SH  
England  
Phone: 44.1243.863121  
Fax: 44.1243.845354

### **MIDDLE EAST AND AFRICA**

Emerson Process Management  
EPM Building  
P. O. Box 17033  
Jebe Ali Free Zone  
Dubai, United Arab Emirates  
T 971.4.8835235  
F 971.4.8835312

**VISIT OUR WEBSITE AT**  
**[www.rosemountanalytical.com](http://www.rosemountanalytical.com)**



## WARRANTY

Seller warrants that the firmware will execute the programming instructions provided by Seller, and that the Goods manufactured or Services provided by Seller will be free from defects in materials or workmanship under normal use and care until the expiration of the applicable warranty period. Goods are warranted for twelve (12) months from the date of initial installation or eighteen (18) months from the date of shipment by Seller, whichever period expires first. **Consumables, such as glass electrodes, membranes, liquid junctions, electrolyte, o-rings, catalytic beads, etc., and Services are warranted for a period of 90 days from the date of shipment or provision.**

Products purchased by Seller from a third party for resale to Buyer ("Resale Products") shall carry only the warranty extended by the original manufacturer. Buyer agrees that Seller has no liability for Resale Products beyond making a reasonable commercial effort to arrange for procurement and shipping of the Resale Products.

If Buyer discovers any warranty defects and notifies Seller thereof in writing during the applicable warranty period, Seller shall, at its option, promptly correct any errors that are found by Seller in the firmware or Services, or repair or replace F.O.B. point of manufacture that portion of the Goods or firmware found by Seller to be defective, or refund the purchase price of the defective portion of the Goods/Services.

All replacements or repairs necessitated by inadequate maintenance, normal wear and usage, unsuitable power sources, unsuitable environmental conditions, accident, misuse, improper installation, modification, repair, storage or handling, or any other cause not the fault of Seller are not covered by this limited warranty, and shall be at Buyer's expense. Seller shall not be obligated to pay any costs or charges incurred by Buyer or any other party except as may be agreed upon in writing in advance by an authorized Seller representative. All costs of dismantling, reinstallation and freight and the time and expenses of Seller's personnel for site travel and diagnosis under this warranty clause shall be borne by Buyer unless accepted in writing by Seller.

Goods repaired and parts replaced during the warranty period shall be in warranty for the remainder of the original warranty period or ninety (90) days, whichever is longer. This limited warranty is the only warranty made by Seller and can be amended only in a writing signed by an authorized representative of Seller. Except as otherwise expressly provided in the Agreement, THERE ARE NO REPRESENTATIONS OR WARRANTIES OF ANY KIND, EXPRESS OR IMPLIED, AS TO MERCHANTABILITY, FITNESS FOR PARTICULAR PURPOSE, OR ANY OTHER MATTER WITH RESPECT TO ANY OF THE GOODS OR SERVICES.

## RETURN OF MATERIAL

Material returned for repair, whether in or out of warranty, should be shipped prepaid to:

**Emerson Process Management  
Rosemount Analytical  
2400 Barranca Parkway  
Irvine, CA 92606**

The shipping container should be marked:

Return for Repair

Model \_\_\_\_\_

The returned material should be accompanied by a letter of transmittal which should include the following information (make a copy of the "Return of Materials Request" found on the last page of the Manual and provide the following thereon):

1. Location type of service, and length of time of service of the device.
2. Description of the faulty operation of the device and the circumstances of the failure.
3. Name and telephone number of the person to contact if there are questions about the returned material.
4. Statement as to whether warranty or non-warranty service is requested.
5. Complete shipping instructions for return of the material.

Adherence to these procedures will expedite handling of the returned material and will prevent unnecessary additional charges for inspection and testing to determine the problem with the device.

If the material is returned for out-of-warranty repairs, a purchase order for repairs should be enclosed.



*The right people,  
the right answers,  
right now.*

**ROSEMOUNT ANALYTICAL  
CUSTOMER SUPPORT CENTER  
1-800-854-8257**



ON-LINE ORDERING NOW AVAILABLE ON OUR WEB SITE  
<http://www.rosemountanalytical.com>

*Specifications subject to change without notice.*

Credit Cards for U.S. Purchases Only.



### Emerson Process Management

2400 Barranca Parkway  
Irvine, CA 92606 USA  
Tel: (949) 757-8500  
Fax: (949) 474-7250

<http://www.rosemountanalytical.com>

© Rosemount Analytical Inc. 2012

